



FAG Partes para Sistema de Freno
Servicio Ligero



2022-2023

SCHAEFFLER



We pioneer motion

Con nuestros productos y soluciones innovadoras, estamos preparando el camino para la movilidad del futuro que será guiada por la movilidad eléctrica, optimizando los motores de combustión interna que actualmente se utilizan. Aunque actualmente seguimos participando activamente en ambos campos, estamos creando una base firme para la movilidad eléctrica a través de nuestra división de sistemas de e-Mobility. Y en el caso de los motores de combustión interna, trabajamos para convertir el potencial de optimización hasta un 30% más eficaz.

Actualmente, Schaeffler es un proveedor para casi todos los fabricantes de vehículos automotores. Sin embargo, en cuanto a movilidad, no nos limitamos a la división automotriz. Schaeffler tiene una gran participación en el desarrollo y fabricación de rodamientos y componentes de precisión para maquinaria de otras industrias. Ha suministrado una amplia gama de productos tanto al mercado de los vehículos impulsados por pedales convencionales, como para bicicletas eléctricas (e-bikes). Además, tenemos más de 100 años desarrollando soluciones innovadoras para aplicaciones en vehículos ferroviarios, tales como rodamientos de rueda, componentes para motores de tracción y de transmisión; rodamientos para vagones de tren y sistemas de inclinación, así como puertas y otras numerosas aplicaciones. En el sector aeroespacial, hemos fabricado rodamientos de alta precisión para motores de aviones, helicópteros, así como para el Transbordador Espacial de Estados Unidos, y el vehículo de lanzamiento "Ariane" en Europa.

Respecto a la movilidad del futuro, continuamos avanzando a lo largo del camino para que nuestra compañía siga siendo considerada como una empresa líder en innovación, brindando respuestas inteligentes a los grandes retos que nos presentan los avances tecnológicos.

SCHAEFFLER

Características de las pastillas FAG	3
Diagnóstico de fallas	5
Procedimiento de purga del cilindro maestro	8
Estructura, simbología y nomenclaturas del catálogo	10
Aplicaciones por marca y modelo	14

Acura	14
Audi	14
BMW	24
Buick	30
Cadillac	30
Chevrolet	34
Chrysler	58
Dodge	68
Fiat	78
Ford	80
GMC	108
Honda	110
Hummer	116
Hyundai	116
Infiniti	118
Jaguar	120
Jeep	120
Kia	124
Lincoln	126
Mazda	130
Mercedes Benz	130
Mercury	136
Mini	136
Mitsubishi	138
Nissan	140

Peugeot	154
Pontiac	156
Ram	160
Renault	164
Saab	166
Seat	168
Smart	170
Suzuki	170
Toyota	172
Vam	178
Volkswagen	180
Volvo	192
Autos de procedencia extranjera	194

Diagramas y medidas de pastillas de freno	207
Diagramas y medidas de zapatas	248
Imágenes y medidas de rotores	262
Imágenes y medidas de tambores	294
Imágenes y medidas de cilindros maestros	302
Imágenes y medidas de cilindros de rueda	330

Cruce de referencias rotores y tambores	345
Cruce de referencias partes hidráulicas	354



MÁXIMA SEGURIDAD

FAG

FAG ¡La mejor opción para la seguridad de su familia!

FAG ofrece al mercado de refacciones una completa gama de productos de alta calidad. Los productos FAG están diseñados y fabricados para cumplir con los más estrictos estándares de la industria, nuestra meta es continuar entregando productos de la más alta calidad para todo lo tipo de vehículos.

¡Para FAG, su seguridad es primero!



REXPERT.MX

Servicio Técnico: 800 8000 585

Lun - Vier 9:00 a 18:00

servicio.tecnico@schaeffler.com

info@rexpert.mx

www.rexpert.mx

www.schaeffler.mx

SCHAEFFLER

Su seguridad es lo más importante

Gracias a la calidad de sus productos, FAG Partes para Freno ha logrado posicionarse como una de las marcas preferidas en el mercado de repuestos nacional, ofreciendo una excelente cobertura para todas las marcas de vehículos.

FAG ha sido parte de los proveedores más importantes de sistemas para frenos en calidad de equipo original para el mercado mexicano.

Los productos FAG están diseñados y manufacturados para cumplir con los más estrictos estándares de la industria, nuestra meta es continuar entregando productos de la más alta calidad para todo lo tipo de vehículos.

¡FAG es la Solución en Frenos!

Conoce nuestras Formulaciones de Pastillas de Freno:

FAG Ceramic Stop^{PRO}

FAG SemiMetallic Safe^{PRO}

FAG Ceramic Stop^{PRO}

Avanzada fórmula de fibras cerámicas, resinas modificadas y materias primas de alta calidad, específicamente diseñadas para cumplir los más altos estándares de calidad, seguridad y desempeño. Las pastillas FAG Ceramic Stop^{PRO} ofrecen un desempeño de frenado superior en cualquier condición de manejo.

Ecológicamente amigable, la formulación de las pastillas FAG Ceramic Stop^{PRO}, está diseñada 100% libre de cobre, cumpliendo de esta manera con las más recientes regulaciones ecológicas internacionales.

Con cobertura amplia y diseñadas para proporcionar un frenado seguro y silencioso, las pastillas FAG Ceramic Stop^{PRO} son la mejor elección para quienes buscan gran desempeño, alta durabilidad, frenado confortable y rines más limpios.

Características:

- Formulaciones ecológicas, 100% libres de cobre
- Alta durabilidad
- Máxima potencia de frenado en cualquier situación
- Mínimo desgaste de rotores
- Menor distancia de frenado
- Rines más limpios
- Frenado confortable y silencioso
- Alta capacidad de disipación de temperatura y rápida recuperación
- Excelente sensación de tacto del pedal
- Rápido asentamiento
- Shims anti-ruido incluidos
- Zapatas con sistema de Retención Mecánico que evita el desprendimiento del material de fricción (en aplicaciones específicas)
- Ranuras y chaflanes (de acuerdo a Equipo Original)
- Hardware incluido (en aplicaciones específicas)



FAG SemiMetallic Safe^{PRO}

Las pastillas FAG SemiMetálic Safe^{PRO} están específicamente desarrolladas para cada tipo de vehículo, ofreciendo seguridad y un gran desempeño de frenado en cualquier tipo de vehículo y condición de manejo.

La gran estabilidad de los componentes utilizados en la manufactura de las pastillas FAG SemiMetallic Safe^{PRO} dan como resultado una eficiencia de frenado sobresaliente y predecible, máxima capacidad de disipación de temperatura y rápida recuperación, aún en las situaciones de manejo más extremas.

Aseguran coeficientes de fricción estables desde la primera frenada y durante toda la vida útil de las pastillas, menor desgaste de rotores, baja producción de polvo y reduce al mínimo el periodo de asentamiento de las pastillas.

Las pastillas FAG SemiMetallic Safe^{PRO} cumplen con las regulaciones ambientales internacionales más estrictas.

Características:

- Frenado estable y seguro aún en situaciones de frenado extremas
- Alta capacidad de disipación de temperatura y rápida recuperación
- Gran durabilidad
- Ecológicas
- Mínimo periodo de asentamiento
- Zapatas con Sistema de Retención Mecánico que evita el desprendimiento del material de fricción (en aplicaciones específicas)
- Shims anti-ruido incluidos (en aplicaciones específicas)
- Ranuras y chaflanes (de acuerdo a Equipo Original)
- Hardware incluido (en aplicaciones específicas)
- Bajo desgaste de rotores
- Excelente sensación de tacto del pedal
- Baja emisión de polvo
- Amplia cobertura para autos americanos, asiáticos y europeos



Desgaste irregular (en forma de cuña).

CAUSA:

- Deformación del cáliper, cáliper pegado, pistón del cáliper deformado, demasiado juego del cáliper, cáliper descentrado o flojo, porta-cáliper con daño, bujes desgastados, pernos guía o correderas del cáliper desgastadas.

SOLUCIÓN:

- Reemplazar pastillas de freno.
- Verificar estado de pernos guía y bujes; lubricar adecuadamente.
- Revisar y evaluar las condiciones de los cálipers y porta cálipers.
- Inspeccionar los alojamientos de los pernos guía.



Material de fricción cristalizado.

CAUSA:

- Abuso del pedal de freno durante el periodo de asentamiento.
- Rectificado de rotores deficiente.

SOLUCIÓN:

- Adecuado procedimiento de asentamiento.
- Reemplazo de las pastillas.
- Revisión del estado de los rotores.

Desgaste disparejo (pastilla exterior).

CAUSA:

- Pernos guía y bujes fuera de especificación.
- Selección incorrecta del número de parte.

SOLUCIÓN:

- Reemplace el juego de pastillas.
- Verifique el estado de los pernos guía y bujes.
- Inspeccione y limpie las correderas del cáliper; lubricar adecuadamente.
- Inspeccione los alojamientos de los pernos guía en el cáliper.



Desgaste disparejo (pastilla interior).

CAUSA:

- Liga del cáliper desgastada o dañada obstruye el retorno del pistón.
- Pernos guía y bujes fuera de especificación.
- Registros de la pastilla dañados.
- Pistones dañados o con señales de corrosión.
- Cilindro maestro con problemas de obstrucción.

SOLUCIÓN:

- Reemplazar pastillas de freno.
- Inspeccione el sistema hidráulico.
- Verificar posible presión residual.
- Revise el estado de los pernos guía y bujes.



Sobrecalentamiento.

CAUSA:

- Ligas del cáliper en mal estado (pistones pegados).
- Presión residual en las líneas hidráulicas.
- Rotores fuera de especificación.
- Herrajes en mal estado o incompletos.
- Vehículos sobrecargados o modificados.
- Abuso del freno por parte del conductor.

SOLUCIÓN:

- Reemplace el juego de pastillas.
- Procedimiento de asentamiento adecuado.
- Inspección de bujes de los pernos guía y el cubrepolvo del cáliper.
- Limpiar y lubricar pernos guía y correderas del cáliper.
- Revisar los alojamientos de los pernos guía.



Asentamiento irregular.

CAUSA:

- Selección inadecuada de rotores o pastillas.
- Pernos guía o soportes de cáliper desgastados.
- Rotores sin rectificar o rectificadas incorrectamente.

SOLUCIÓN:

- Reemplace el juego de pastillas.
- Verifique el diámetro del rotor con las especificaciones de Equipo Original.



Pastilla contaminada.

CAUSA:

- Fuga del líquido de freno (mangueras rotas, ligas de pistón dañadas).
- Grasa del cubrepolvo de la junta homocinética.
- Fuga de aceite en los retenes del motor.
- Fugas de líquido en mangueras o tuberías de dirección.

SOLUCIÓN:

- Reemplace el juego de pastillas una vez solucionada la causa de la contaminación.



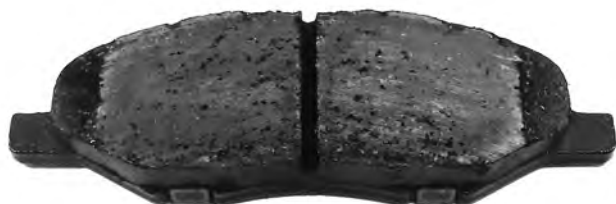

Desgaste prematuro.

CAUSA:

- Sobrecalentamiento del material de fricción debido al uso excesivo del sistema de frenos.
- Desgaste por arrastre de frenos debido a fallas en el cáliper.
- Aplicación incorrecta de pastilla o rotor.
- Vehículos sobrecargados o modificados.
- Herrajes dañados.

SOLUCIÓN:

- Reemplace el juego de pastillas.
- Procedimiento de asentamiento adecuado.
- Inspección del estado del cáliper, reemplazar en caso de ser necesario.

Golpeado o deformado.

CAUSA:

- Falta de limpieza en el porta pastilla.
- Selección incorrecta del número de parte.
- Golpes o deformaciones provocadas al instalar las pastillas.

SOLUCIÓN:

- Reemplazar las pastillas de freno.
- Limpieza general.

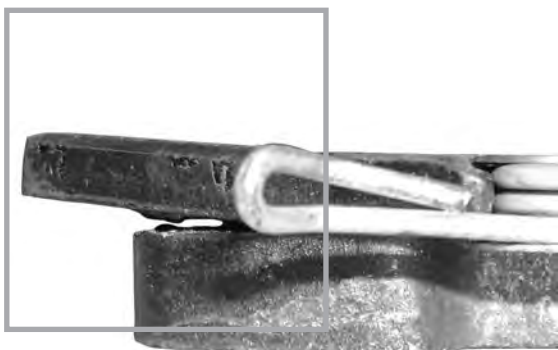

Deformación o fractura.

CAUSA:

- Flexión de la balata por instalación inadecuada.
- Selección incorrecta de número de parte.
- Fallas en el cáliper.

SOLUCIÓN:

- Reemplace el juego de pastillas.
- Procedimiento de asentamiento adecuado.
- Inspección del estado del cáliper, reemplazar en caso de ser necesario.

Procedimiento de purga del cilindro maestro

Para garantizar el correcto funcionamiento del cilindro maestro de frenos FAG, recomendamos que antes de instalarlo en el vehículo, realice el procedimiento de purgado en banco que a continuación se describe:

1. Coloque el cilindro maestro en un tornillo de banco, sujételo por la placa de montaje, evite apretar excesivamente para no dañar el cilindro.

2. Conecte las mangueras de purga en los barrenos de salida del líquido y dóblelas para que el extremo opuesto quede en el interior del (los) depósito(s).

3. Llene el (los) depósito(s) con líquido para frenos nuevo hasta la mitad del depósito(s), con el fin de mantener sumergidos los extremos de las mangueras de purga dentro del líquido. Recuerde utilizar el líquido de freno recomendado por el fabricante del vehículo (DOT3 ó DOT4), generalmente esta información aparece en la tapa del cilindro maestro de su vehículo.

4. Utilice una varilla con un extremo redondeado, bombee lentamente hasta que los pistones realicen su recorrido completo dentro de las cámaras del cilindro, posteriormente, suelte la varilla hasta que regrese a la posición inicial y espere de 5 a 10 segundos, repita la operación hasta que dejen de salir burbujas de aire en los depósitos.

5. Sin remover el líquido de frenos del cilindro maestro, instálelo en el vehículo, retire las mangueras de purga y rápidamente atornille las tuberías del sistema de frenos en los barrenos del cilindro maestro.

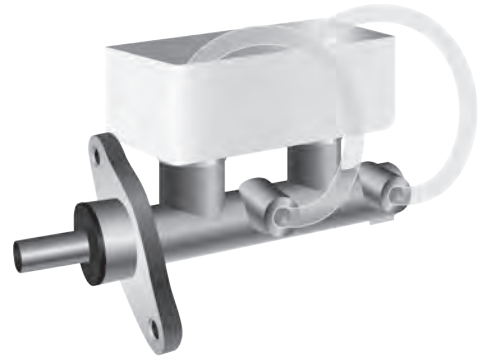

El derrame de líquido de frenos en la carrocería del vehículo puede dañar la pintura, en caso necesario, lave con abundante agua.

Procedimiento de cambio de líquido del sistema de freno

1. Proceda a purgar los frenos de las ruedas del vehículo:

a) Vehículos de tracción trasera equipados con sistema de división traseros/delanteros, inicie la purga en la rueda más alejada del cilindro maestro y termine con la rueda más próxima. En la mayoría de los vehículos, el orden debe ser: trasera derecha, trasera izquierda, delantera derecha, delantera izquierda.

b) Vehículos equipados con sección de división diagonal, siga el procedimiento de purga que se recomienda en el manual de usuario o en el manual de servicio del vehículo. El orden que recomendado para estos sistemas es: trasera derecha, delantera izquierda, trasera izquierda, delantera derecha.

Si el vehículo tiene dos cilindros de rueda en un freno, purgue primero el cilindro superior.



Purga del sistema de frenos en vehículos con ABS

Para asegurar el óptimo funcionamiento del sistema de frenos en vehículos equipados con ABS, es necesario seguir las indicaciones recomendadas por el fabricante.



Purga del cilindro maestro de Chevrolet Chevy

Verifique que el vástago del booster no esté dañado, oxidado o golpeado e instale el cilindro maestro. Aplique los pasos 3, 4 y 5 del procedimiento de purga. Si no se sigue este procedimiento, el líquido de frenos fugará al exterior.

SIMPLEMENTE EL MEJOR



Con la OAP, puedes confiar en nuestra experiencia

La OAP fue inventada por ingenieros de Schaeffler en 1995. Desde entonces, en INA hemos producido más de 250 millones de unidades manteniendo un desarrollo continuo de la OAP.

www.rexpert.mx

SCHAEFFLER



Posición del eje al que hace referencia la información

		EJE DELANTERO									
		PASTILLA	SM	CM	ROTOR	TIPO	CILINDRO MAESTRO	MEDIDA mm - in			
CHEVROLET											
MALIBU											
Marca modelo	L4	97-99	D72775940	✓	-	BFR131710	Vent	BMC10185	25.4	1"	
		00-01	D72775940	✓	-	BFR131710	Vent	BMC10235	23.8	15/16"	
		04-06	D10287932	✓	✓	BFR136410	Vent	BMC10299	23.8	15/16"	

Marca modelo

Motor o característica

Años que aplica

Pastilla delantera

Formulación disponible

Rotor delantero

Sólido/ventilado

Cilindro maestro

Medida (cilindro maestro)

Símbolos

Aplicaciones	Diagramas pastillas	Diagramas zapatas	Imágenes rotores	Imágenes tambores
Imágenes cilindros maestros	Imágenes cilindros de ruedas	Referencias cruzadas		

El presente catálogo ha sido elaborado con gran cuidado habiéndose verificado la exactitud de los datos contenidos en él, sin embargo, no nos hacemos responsables por posibles datos erróneos o incompletos.

Debido al continuo desarrollo de nuestros productos, nos reservamos el derecho de introducir modificaciones.

Schaeffler Automotive Aftermarket Mexico S. de R.L. de C.V.



Posición del eje al que hace referencia la información

EJE TRASERO							i
PASTILLA / ZAPATA	SM	CM	ROTOR / TAMBOR	TIPO	CILINDRO DE RUEDA	MEDIDA mm - in	
CHEVROLET							
MALIBU							
			BRD130610		WBC50143	22.2 7/8"	D/I
			BRD130610		WBC50143	22.2 7/8"	D/I
S86015350			BRD131510		WBC50192	22.2 7/8"	D/I

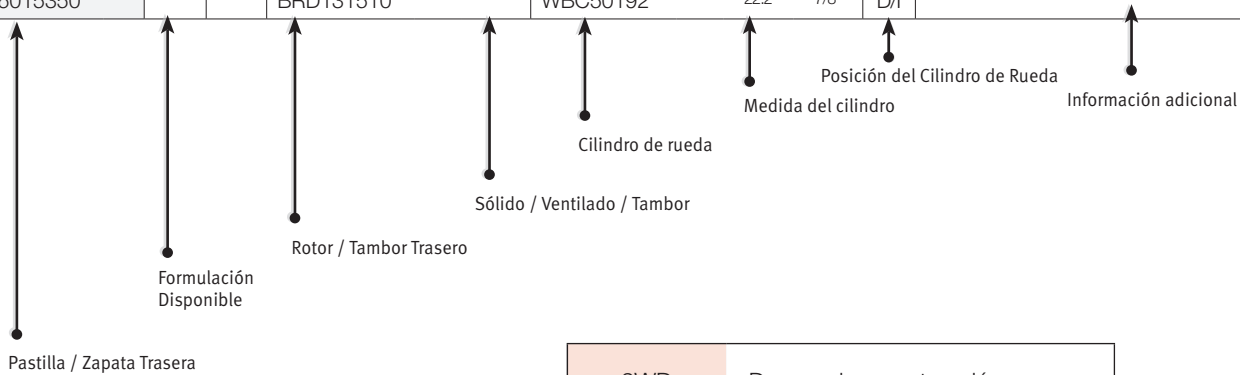

Símbolos

	Rotor
	Tambor
	Cilindro Maestro
	Cilindro de Rueda
	Pastilla de Freno
	Marca y Modelo
	Año
	Información
	Zapata de Freno

2WD	Dos ruedas con tracción
4WD	Cuatro ruedas con tracción
AWD	Tracción total
FWD	Tracción delantera
ESP	Control de Estabilidad Electrónico (Electronic Stability Program)
HB	Hatchback
HD	Servicio Pesado (Heavy Duty)
hp	Caballos de fuerza
PBV	Peso Bruto Vehicular
T/A	Transmisión automática
T/M	Transmisión manual
TDI	Turbo Diesel Injection



Como solicitar el número FAG en las diferentes formulaciones



D11078212

SemiMetallic Safe^{PRO}

Utilizar el número de parte como se describe en el catálogo



CMD11078212

Ceramic Stop^{PRO}

Añadir el prefijo CM al número de parte que se indica en el catálogo

Pastillas de freno

D280 7209 0

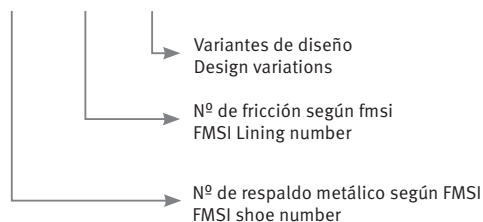

Zapatas de freno

S736 1504 0

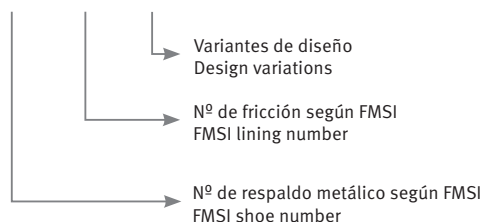

Descripción de número de parte FAG para rotores y tambores

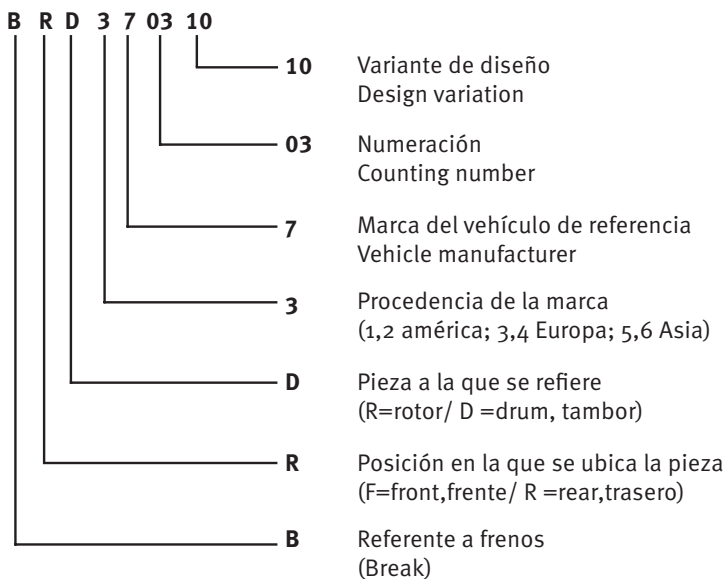

El presente catálogo ha sido elaborado con gran cuidado habiéndose verificado la exactitud de los datos contenidos en él, sin embargo, no nos hacemos responsables por posibles datos erróneos o incompletos. Debido al continuo desarrollo de nuestros productos, nos reservamos el derecho de introducir modificaciones.
Schaeffler Automotive Aftermarket Mexico S. de R.L. de C.V.

WheelDisc LA UNIÓN PERFECTA



FAG

Mediante la integración de los rotores y tambores con los rodamientos de calidad Equipo Original, Schaeffler da un paso adelante en la oferta de Soluciones de Reparación para el instalador.

La instalación de los rotores y tambores con rodamientos pre-ensamblados (donde aplica) no sólo garantiza el perfecto ensamble del rodamiento asegurando así una larga vida útil, si no que también ahorra tiempo y reduce costos de reparación.



REXPERT.MX
Servicio Técnico: 800 8000 585
Lun - Vier 9:00 a 18:00
servicio.tecnico@schaeffler.com
info@rexpert.mx
www.rexpert.mx
www.schaeffler.mx

SCHAEFFLER



						EJE DELANTERO					MEDIDA mm - in	
						PASTILLA	SM	CM	ROTOR	TIPO		
ACURA												
ILX												
	2.0L	13-15	D91477950	✓	✓	BFR510410 ⁽¹⁾	Vent	BMC10587	20.6	13/16"		
						BFR510510 ⁽²⁾	Vent					
	2.4L	16-20	CMD16978840	-	✓			BMC10587	20.6	13/16"		
MDX												
	3.7L	05-06	D85575660	✓	✓	BFR510710	Vent	BMC10339	27.0	1 1/16"		
		07-13	D12808396	✓	✓	BFR511410	Vent	BMC10336	22.2	7/8"		
	3.5L	14-16	CMD17238396	-	✓							
		17-20	CMD17238396	-	✓	BFR512610	Vent					
RDX												
	AWD	07-12	D10897994	✓	✓	BFR511110	Vent					
		13-18	CMD16978840	-	✓							
		19->	D15217994	✓	✓							
RLX												
		14-15	CMD16978840	-	✓							
TL												
		05-08	D78776560	✓	-	BFR510710	Vent					
		09-13	D11028208	✓	✓	BFR512010	Vent	BMC10448	22.2	7/8"		
TLX												
		15-17	CMD15848208	-	✓							
		18-20	CMD15848208	-	✓							
TSX												
		09-10	D78776560	✓	-	BFR510710	Vent	BMC10373	20.6	13/16"		
		11-13	D15067656	✓	✓	BFR510710	Vent	BMC10373	20.6	13/16"		
ZDX												
		10-11	D12808396	✓	✓	BFR511410	Vent	BMC10336	22.2	7/8"		
AUDI												
A1 / SPORTBACK												
		11-14	D11078212	✓	✓	BFR371310	Vent	BMC10571	22.2	7/8"		
								BMC10615	22.2	7/8"		
		15-18	D11078212	✓	✓	BFR371310	Vent					
		20->	CMD17608989	-	✓							
S1 / SPORTBACK												
		13-15	D11078212	✓	✓	BFR371310	Vent					
		16-18	D11078212	✓	✓	BFR371310	Vent					
		20->	CMD17608989	-	✓							
A3												
	1.8T	1998				BFR370710	Vent					
		99-01	D7687635A	✓	✓	BFR370710	Vent					
		02-04	D7687635A	✓	✓	BFR370710	Vent	BMC10202	23.8	15/16"		







		EJE TRASERO						
PASTILLA / ZAPATA			TIPO		CILINDRO DE RUEDA	MEDIDA mm - in	I / D	
ACURA								
ILX								
D53774180	✓	✓	BRR511010	Sol				(1) diámetro de 281.0 mm (2) diámetro de 300.0 mm
D53774180	✓	✓	BRR511710	Sol				
MDX								
D86577400	✓	✓	BRR510610	Sol				
D12818397	✓	✓	BRR510910	Sol				
CMD17248397	—	✓						
RDX								
D53674180	✓	✓	BRR511110	Sol				
D10867418	✓	✓	BRR511110	Sol				
CMD18789106	—	✓						
RLX								
TL								
D53674180	✓	✓						
D11038209	✓	✓						
TLX								
			BRR512510	Sol				
TSX								
D13368447	✓	✓	BRR511710	Sol				
D14518447	✓	✓	BRR511710	Sol				
ZDX								
D12818397	✓	✓	BRR510910	Sol				
AUDI								
A1 / SPORTBACK								
D34073350	✓	✓	BRR370510	Sol				
D34073350	✓	✓	BRR370510	Sol				
S1 / SPORTBACK								
D14568656	✓	✓	BRR370510	Sol				
D14568656	✓	✓	BRR374710	Sol				
CMD17799008	—	✓						
A3								
D34073350	✓	✓	BRR370510	Sol				
D34073350	✓	✓	BRR370510	Sol				



			EJE DELANTERO								
			 PASTILLA			 ROTOR	TIPO	CILINDRO MAESTRO	MEDIDA mm - in		
AUDI											
A3 cont.											
	1.8T	07-08	D5557434A	✓	✓	BFR371310	Vent	BMC10425 ⁽¹⁾ BMC10426 ⁽²⁾	22.2	7/8"	
	2.0L	04-08	D7687635A	✓	✓	BFR370710	Vent	BMC10425 ⁽¹⁾ BMC10426 ⁽²⁾	22.2	7/8"	
	3.2L	05-08	D5557434A	✓	✓	BFR371310	Vent	BMC10425 ⁽¹⁾ BMC10426 ⁽²⁾	22.2	7/8"	
	2.0T	05-08	D11078212	✓	✓	BFR371910	Vent	BMC10425 ⁽¹⁾ BMC10426 ⁽²⁾	22.2	7/8"	
		08-10	D11078212	✓	✓	BFR371910	Vent	BMC10425 ⁽¹⁾ BMC10426 ⁽²⁾	22.2	7/8"	
		10-13	D11078212	✓	✓	BFR371910	Vent	BMC10425 ⁽¹⁾ BMC10426 ⁽²⁾	22.2	7/8"	
		2014	CMD19689193	—	✓						
		15-16	CMD17608989 CMD19689193	— —	✓ ✓	BFR371910	Vent				
		17-18	CMD17608989	—	✓	BFR371910	Vent				
	Sportback	2.0T	05-06	D11078212	✓	✓	BFR371910	Vent	BMC10425 ⁽¹⁾ BMC10426 ⁽²⁾	22.2	7/8"
2.0L			D76877090	✓	✓	BFR370710	Vent	BMC10425 ⁽¹⁾ BMC10426 ⁽²⁾	22.2	7/8"	
		07-08	D11078212	✓	✓	BFR371910	Vent	BMC10425 ⁽¹⁾ BMC10426 ⁽²⁾	22.2	7/8"	
		09-11	D11078212	✓	✓	BFR372210	Vent	BMC10425 ⁽¹⁾ BMC10426 ⁽²⁾	22.2	7/8"	
		12-13	D11078212	✓	✓	BFR371910	Vent	BMC10425 ⁽¹⁾ BMC10426 ⁽²⁾	22.2	7/8"	
Quattro / Sportback Quattro		04-09	D11078212	✓	✓	BFR371910	Vent	BMC10425 ⁽¹⁾ BMC10426 ⁽²⁾	22.2	7/8"	
Quattro / Sportback Plus Quattro		2010	D11078212	✓	✓	BFR371910	Vent	BMC10425 ⁽¹⁾ BMC10426 ⁽²⁾	22.2	7/8"	
		2011	D11078212	✓	✓	BFR371910	Vent	BMC10425 ⁽¹⁾ BMC10426 ⁽²⁾	22.2	7/8"	
Cabrio		09-13	D11078212	✓	✓	BFR371910	Vent	BMC10425 ⁽¹⁾ BMC10426 ⁽²⁾	22.2	7/8"	
		15-16	CMD19689193 CMD17608989	— —	✓ ✓	BFR371910 ⁽¹⁾	Vent				
		17-20	CMD17608989	—	✓	BFR372210 ⁽¹⁾ BFR371910 ⁽²⁾	Vent				
Sedán		14-20	CMD17608989	—	✓	BFR372210 ⁽¹⁾ BFR371910 ⁽²⁾	Vent				

PASTILLA / ZAPATA				ROTOR / TAMBOR	TIPO	CILINDRO DE RUEDA	MEDIDA mm - in	I / D	
AUDI									
A3 cont.									
D34073350	✓	✓	BRR370510	Sol					(1) con cilindro original ATE (2) con cilindro original FTE
D34073350	✓	✓	BRR370510	Sol					(1) con cilindro original ATE (2) con cilindro original FTE
D34073350	✓	✓	BRR370510	Sol					(1) con cilindro original ATE (2) con cilindro original FTE
D11088213	✓	✓	BRR370910	Sol					(1) con cilindro original ATE (2) con cilindro original FTE
D11088213	✓	✓	BRR372010 BRR370910	Sol Sol					(1) con cilindro original ATE (2) con cilindro original FTE
D11088213	✓	✓	BRR374710 BRR370910	Sol Sol					(1) con cilindro original ATE (2) con cilindro original FTE
D14568656	✓	✓	BRR375410	Sol					
CMD17618990	—	✓							
CMD17618990	—	✓							
CMD17618990	—	✓	BRR375410	Sol					
D11088213	✓	✓	BRR370910	Sol					(1) con cilindro original ATE (2) con cilindro original FTE
D34073350	✓	✓	BRR370510	Sol					
D11088213	✓	✓	BRR370910	Sol					(1) con cilindro original ATE (2) con cilindro original FTE
D11088213	✓	✓	BRR374710 BRR370910	Sol Sol					(1) con cilindro original ATE (2) con cilindro original FTE
D14568656	✓	✓	BRR370910	Sol					(1) con cilindro original ATE (2) con cilindro original FTE
D11088213	✓	✓	BRR370910	Sol					(1) con cilindro original ATE (2) con cilindro original FTE
D11088213	✓	✓	BRR372010	Sol					(1) con cilindro original ATE (2) con cilindro original FTE (3) sólo con frenos TRW 2010
D11088213	✓	✓	BRR370910	Sol					(1) con cilindro original ATE (2) con cilindro original FTE (3) sólo con frenos TRW 2010
D11088213	✓	✓	BRR372010 BRR370910	Sol Sol					(1) con cilindro original ATE (2) con cilindro original FTE
CMD17618990	—	✓	BRR375410	Sol					(1) diámetro de 312 mm
CMD17618990	—	✓	BRR374710	Sol					(1) diámetro de 288 mm (2) diámetro de 312 mm
CMD17618990	—	✓	BRR374710	Sol					(1) diámetro de 288 mm (2) diámetro de 312 mm









		 2012... 2013... 2014...		EJE DELANTERO						
				 PASTILLA			 ROTOR	TIPO	CILINDRO MAESTRO	MEDIDA mm - in
AUDI										
S3										
HB		00-04	D5557434A	✓	✓					
		06-09	D11078212	✓	✓	BFR371910	Vent			
		10-13	D11078212	✓	✓	BFR371910	Vent			
		14-18	CMD16338849	-	✓	BFR376010	Vent			
Sedán	2.0T	15-20	CMD16338849	-	✓	BFR376010	Vent			
A4										
	L4	97-00	D5557434A	✓	✓	BFR371710	Vent			
	L4	01-04	D84077150	✓	✓	BFR371710	Vent	BMC10263 25.4 1"		
	V6		D84077150	✓	✓			BMC10263 25.4 1"		
	1.8T	05-06	D84077150	✓	✓			BMC10263 25.4 1"		
	3.2L									
	1.8T	07-08	D84077150	✓	✓			BMC10263 25.4 1"		
	2.0T									
	V6									
			09-11	CMD13228434	-	✓	BFR370810	Vent		
			12-16	CMD13228434	-	✓				
		17-19	CMD19539180	-	✓					
Cabrio	1.8T	03-06	D84077150	✓	✓	BFR371710	Vent			
	V6		D84077150	✓	✓					
		07-08								
Quattro	2.8L,1.8T	97-01	D5557434A	✓	✓	BFR371710	Vent			
	1.8T	02-05	D84077150	✓	✓	BFR371710 ⁽¹⁾	Vent			
	V6		D84077150	✓	✓					
	2.0T	05-06	D84077150	✓	✓					
	V6									
		07-08								
			09-11	CMD13228434	-	✓	BFR370810	Vent		
			12-16	CMD13228434	-	✓				
		17-18	CMD19539180	-	✓					
S4										
Sedán		00-01								
		04-09								
		10-11	CMD13228434	-	✓					
		12-16	CMD13228434	-	✓					
		17-19								
Cabrio		07-09								
		10-11	CMD13228434	-	✓					
3.0T		13-16	CMD13228434	-	✓					
		17-18		-	-					
A5 / SPORTBACK										
		08-11	CMD13228434	-	✓	BFR370810	Vent			
		12-16	CMD13228434	-	✓					

		EJE TRASERO						
PASTILLA / ZAPATA			 ROTOR / TAMBOR	TIPO	 CILINDRO DE RUEDA	MEDIDA mm - in	I / D	
AUDI								
S3								
D34073350	✓	✓						
D11088213	✓	✓	BRR370910	Sol				
D14568656	✓	✓	BRR370910	Sol				
CMD17618990	—	✓						
CMD17618990	—	✓						
A4								
D34072340	✓	✓						
D34072340	✓	✓						
D34072340	✓	✓						
D34072340	✓	✓						
D34072340	✓	✓						
D11088213	✓	✓						
D10187921	✓	✓						
CMD13868494	—	✓	BRR371510	Sol				
CMD13868494	—	✓	BRR371510	Sol				
CMD18989126	—	✓	BRR371510	Sol				
D34072340	✓	✓						
D34072340	✓	✓						
D11088213	✓	✓						
D34072340	✓	✓						
D34072340	✓	✓						
D10187921	✓	✓						
D34073350	✓	✓						
D11088213	✓	✓						
CMD13868494	—	✓	BRR371510	Sol				
CMD13868494	—	✓	BRR371510	Sol				
CMD18989126	—	✓						
S4								
D34073350	✓	✓						
D10187921	✓	✓						
CMD13868494	—	✓						
CMD13868494	—	✓						
CMD18989126	—	✓						
D10187921	✓	✓						
CMD13868494	—	✓						
CMD13868494	—	✓						
CMD18989126	—	✓						
A5 / SPORTBACK								
CMD13868494	—	✓	BRR371510	Sol				
CMD13868494	—	✓	BRR371510	Sol				





		 2012... 2013... 2014...		EJE DELANTERO						
				 PASTILLA			 ROTOR	TIPO	CILINDRO MAESTRO	MEDIDA mm - in
AUDI										
A5 / SPORTBACK cont.										
	2.0T 190 hp	18-19	CMD19539180	-	✓					
	2.0T 252 hp									
	3.0T 354 hp									
S5 / SPORTBACK										
		08-16	CMD13228434	-	✓					
		18-19								
A6										
Sedán		98-01	D5557434A	✓	✓	BFR371710	Vent			
		02-04	D84077150	✓	✓		BMC10263	25.4 1"		
		05-11								
		12-13	CMD13228434	-	✓					
		2014	CMD13228434	-	✓					
	L4	16-18	CMD16638891 ⁽¹⁾	-	✓					
Sedán Quattro	Rin 15"	98-01	D5557434A	✓	✓	BFR371710				
	Rin 16"		D5557434A	✓	✓					
	V6	00-01	D84077150	✓	✓					
	V8									
	V6	02-04	D84077150	✓	✓					
	V8									
	V6	05-08								
	V8									
	V6	09-11								
	V8									
V6 TDI	2014	CMD13228434	-	✓						
S6										
Sedán		01-04	D84077150	✓	✓					
		07-11								
A7 / SPORTBACK / QUATTRO										
		12-13								
A8										
Quattro		97-99	D5557434A	✓	✓					
		2000	D84077150	✓	✓					
		01-03								
		04-10								
S8										
Sedán Quattro		01-02	D5557434A	✓	✓					
		07-11								
ALLROAD QUATTRO										
		01-04								







		EJE TRASERO						
PASTILLA / ZAPATA			TIPO		MEDIDA mm - in	I / D		
AUDI								
A5 / SPORTBACK cont.								
CMD18989126	-	✓	BRR371510	Sol				
CMD18989126	-	✓						
CMD18989126	-	✓						
S5 / SPORTBACK								
CMD13868494	-	✓						
CMD18989126	-	✓						
A6								
			BRR370310	Sol				
D34073350	✓	✓	BRR370310	Sol				
D11088213	✓	✓						
			BRR371510	Sol				
							(1) con discos de 356.0 mm	
CMD18989126	-	✓						
D34073350	✓	✓						
D34073350	✓	✓						
D34073350	✓	✓						
D34073350	✓	✓						
D34073350	✓	✓					excepto V6 3.7L biturbo	
D10187921	✓	✓						
D11088213	✓	✓						
D11088213	✓	✓						
D10187921	✓	✓						
S6								
D34073350	✓	✓						
D10187921	✓	✓						
A7 / SPORTBACK / QUATTRO								
			BRR371510	Sol				
A8								
D34072340	✓	✓						
D34072340	✓	✓						
D10187921	✓	✓						
S8								
D10187921	✓	✓						
D10187921	✓	✓						
ALLROAD QUATTRO								
D34073350	✓	✓						



			EJE DELANTERO							
			 PASTILLA			 ROTOR	TIPO	CILINDRO MAESTRO		
AUDI										
Q2										
		18-20	CMD17608989	-	✓	BFR371910	Vent			
Q3										
		13-15	D13758486	✓	✓	BFR371910	Vent			
		16-18	D13758486	✓	✓	BFR371910	Vent			
		20->	CMD17608989	-	✓	BFR371910 ⁽¹⁾	Vent			
						BFR376010 ⁽²⁾	Vent			
RS Q3										
Performance		17-18	D13758486	✓	✓	BFR371910	Vent			
Q5										
		09-11	CMD13228434	-	✓	BFR370810	Vent			
		2012	CMD13228434	-	✓					
	2.0T	13-17	CMD16638891	-	✓					
	3.0L,3.2L		CMD16638891	-	✓					
		18-20								
SQ5										
		14-20								
Q7										
		07-15								
TT COUPÉ										
	L4	00-02	D5557434A	✓	✓			BMC10202	23.8	15/16"
								BMC10449 ⁽¹⁾	23.8	15/16"
		03-06	D5557434A	✓	✓			BMC10449 ⁽¹⁾	23.8	15/16"
		07-10	D11078212	✓	✓	BFR371910	Vent			
		11-13								
		2014 16-18	CMD17608989	-	✓					
	V6	2008				BFR371910	Vent			
		2009	D11078212	✓	✓	BFR371910	Vent			
		10-11								
Quattro	L4	00-02	D5557434A	✓	✓			BMC10202	23.8	15/16"
								BMC10449 ⁽¹⁾	23.8	15/16"
		03-05	D5557434A	✓	✓			BMC10449 ⁽¹⁾	23.8	15/16"
		2006	D5557434A	✓	✓			BMC10449 ⁽¹⁾	23.8	15/16"
		10-11	D11078212	✓	✓	BFR371910	Vent			
	V6	2004	D5557434A	✓	✓					
		05-07								
		08-10								
TT S COUPÉ										
Quattro		09-14								
TT RS COUPÉ										
Quattro		11-14								

EJE TRASERO								i
PASTILLA / ZAPATA	SM	CM	ROTOR / TAMBOR	TIPO	CILINDRO DE RUEDA	MEDIDA mm - in	I / D	
AUDI								
Q2								
CMD17618990	-	✓	BRR374710	Sol				
Q3								
D11088213	✓	✓	BRR370910	Sol				
CMD17799008	-	✓	BRR375410	Sol				
			BRR375410	Sol				(1) diámetro de 312.0 mm (2) diámetro de 340.0 mm
RS Q3								
CMD17799008	-	✓	BRR375410	Sol				
Q5								
CMD13868494	-	✓	BRR371510	Sol				
CMD13868494	-	✓	BRR371510	Sol				
CMD13868494	-	✓	BRR371510	Sol				
CMD13868494	-	✓						
CMD18989126	-	✓						
SQ5								
CMD13868494	-	✓						
Q7								
			BRR373210	Vent				
TT COUPÉ								
D34073350	✓	✓	BRR370510	Sol				(1) con ESP
D34073350	✓	✓	BRR370510	Sol				(1) con ESP
D11088213	✓	✓	BRR370410	Vent				
D11088213	✓	✓						
CMD17618990	-	✓						
D11088213	✓	✓						
D11088213	✓	✓						
D11088213	✓	✓						
D34073350	✓	✓	BRR370510	Sol				(1) con ESP
D34073350	✓	✓	BRR370510	Sol				(1) con ESP
D34073350	✓	✓	BFR371610	Vent				(1) con ESP
D11088213	✓	✓						
D34073350	✓	✓	BFR371610	Vent				
D34073350	✓	✓	BFR371610 (1)	Vent				(1) diámetro de 256.0 mm
D11088213	✓	✓						
TT S COUPÉ								
D11088213	✓	✓						
TT RS COUPÉ								
D11088213	✓	✓						









		 2012... 2013... 2014...		EJE DELANTERO						 PASTILLA				 ROTOR		TIPO		 CILINDRO MAESTRO		MEDIDA mm - in	
																					
AUDI																					
TT ROADSTER																					
		00-03	D5557434A	✓	✓													BMC10449 ⁽¹⁾	23.8	15/16"	
		04-06	D5557434A	✓	✓																
		08-10																			
		11-13	D11078212	✓	✓	BFR371910															
TT S ROADSTER																					
		09-11	D11078212	✓	✓																
BMW																					
120i																					
		05-12				BFR323710															
125i																					
		09-13	D72575920	✓	✓	BFR323110															
320i																					
		01-05	D55874370	✓	✓																
323i																					
		98-01	D78178470	✓	✓																
323Ti																					
		99-00	D78178470	✓	✓																
325i																					
		95-97	D55874370	✓	✓																
		01-05	D78178470	✓	✓	BFR320310															
		06-13	D91877990	✓	✓	BFR323110 ⁽¹⁾															
		09-11	D72575920	✓	✓	BFR323110															
325Ci																					
		01-06	D78178470	✓	✓	BFR320310															
		07-10	D72575920	✓	✓	BFR320310															
		11-13	D72575920	✓	✓	BFR323110															
328i																					
		96-98	D55874370	✓	✓																
		99-00	D78178470	✓	✓	BFR320310															
330i																					
		01-05	D94675920	✓	✓																
		06-07	D72575920	✓	✓																
330Ci																					
		01-06	D94675920	✓	✓																
335i																					
		07-12	D91877990	✓	✓																
335Ci																					
		07-13	D91877990	✓	✓																

PASTILLA / ZAPATA		SM CM		ROTOR / TAMBOR	TIPO	CILINDRO DE RUEDA	MEDIDA mm - in	I / D	i
AUDI									
TT ROADSTER									
D34073350	✓	✓	BFR371610	Vent					(1) con ESP
D34073350	✓	✓	BFR371610	Vent					
D11088213	✓	✓							
D11088213	✓	✓							
TT S ROADSTER									
D11088213	✓	✓							
BMW									
120i									
125i									
320i									
D76376310	✓	✓							
323i									
323Ti									
325i									
D76376310	✓	✓	BRR320610	Vent					
D11717286	✓	✓	BRR322710	Vent					(1) diámetro de 300.0 mm
D11717286	✓	✓	BRR322710	Vent					
325Ci									
D76376310	✓	✓	BFR320610	Vent					
D11717286	✓	✓	BRR322710	Vent					
D11717286	✓	✓	BRR322710	Vent					
328i									
CMD39672860	-	✓							
			BRR320610	Vent					
330i									
D68374270	✓	✓							
330Ci									
D68374270	✓	✓							
335i									
335Ci									



















 		EJE DELANTERO					
		 PASTILLA  	 ROTOR	TIPO	 CILINDRO MAESTRO	MEDIDA mm - in	
BMW							
M3							
		98-99					
		01-02					
Coupé / Cabrio		03-06	D94675920	✓	✓		
		08-13	D91877990	✓	✓		
Sedán		10-12	D91877990	✓	✓		
420i							
Coupé / Grand Coupé		16->					
525i							
		01-03	D72575920	✓	✓		
		2006	D91877990	✓	✓		
		2007					
		08-10	D72575920	✓	✓		
528i							
		96-00	D72575920	✓	✓		
530i							
		04-10	D91877990	✓	✓		
535i							
		2010	D91877990	✓	✓		
545i							
		04-06	D91877990	✓	✓		
550i							
		06-10	D91877990	✓	✓		
M5							
		99-03					
645Ci							
		2005	D91877990	✓	✓		
650i							
M Sport Convertible		12-13	D91877990	✓	✓		
650Ci							
		06-09	D91877990	✓	✓		
740i							
	V8 4.4T	98-01					
740iL							
	V8 4.4L	98-01					
745i							
	V8 4.4L	02-05	D91877990	✓	✓		
745Li							
		03-05	D91877990	✓	✓		

		EJE TRASERO						
PASTILLA / ZAPATA			TIPO			MEDIDA mm - in	I / D	
BMW								
M3								
CMD39672860	-	✓						
D68374270	✓	✓						
D68374270	✓	✓						
420i								
			BRR322710	Vent				
525i								
D10427427	✓	✓						
D10427427	✓	✓						
D68374270	✓	✓						
D10427427	✓	✓						
528i								
530i								
D10427427	✓	✓						
535i								
545i								
550i								
M5								
D68374270	✓	✓						
645Ci								
650i								
650Ci								
740i								
D68374270	✓	✓						
740iL								
D68374270	✓	✓						
745i								
745Li								











			EJE DELANTERO						MEDIDA mm - in
			 PASTILLA			 ROTOR	TIPO		
BMW									
750i									
		06-09	D91877990	✓	✓				
750iL									
	V12 5.4L	95-01							
750Li									
		06-09	D91877990	✓	✓				
760Li									
		03-09	D91877990	✓	✓				
X1									
20i	L4 2.0T	12-15	D91877990	✓	✓				
20i M Sport	L4 2.0T	12-13	D91877990	✓	✓				
25i	L6 3.0L	10-13	D91877990	✓	✓				
28i	L6 3.0L	10-13	D91877990	✓	✓				
28i sDrive X Line	L4 2.0T	12-14	D91877990	✓	✓				
28i sDrive X Sport Line	L4 2.0T	12-14	D91877990	✓	✓				
X3									
2.5i	L6 2.5L	04-11	D94675920	✓	✓	BFR321810	Vent		
3.0i	L 6 3.0L	04-11	D94675920	✓	✓	BFR321810	Vent		
3.0i M Sport	L 6 3.0L	06-11	D94675920	✓	✓	BFR321810	Vent		
X5									
30i	L6 3.0L	01-06				BFR320110	Vent		
3.0Si		07-10							
3.0i M Sport	L6 3.0T	09-10							
V8	4.4L	00-06							
iS	4.8L	04-06							
35i xDrive	3.0T	11-18							
35i xDrive M Sport	3.0T	12-18							
X6									
35i		2010							
35i sDrive		11-19							
35i xDrive M Sport		15-19							
Z3									
		96-99	D55874370	✓	✓				
	L4 2.0L	2000	D78178470	✓	✓				
	L4 2.2L	01-02	D78178470	✓	✓				
	L6 3.0L		D78178470	✓	✓	BFR320310	Vent		
Z3 M									
	L6 3.2L	99-02							
Z4									
2.5i	L6 2.5L	03-09	D78178470	✓	✓				
3.0i	L6 3.0L	03-05	D78178470	✓	✓	BFR320310	Vent		
Si	L6 3.0L	2007	D94675920	✓	✓				

 		EJE TRASERO						
PASTILLA / ZAPATA	 	 ROTOR / TAMBOR	TIPO	 CILINDRO DE RUEDA	MEDIDA mm - in	I / D		
BMW								
750i								
750iL								
D68374270	✓	✓						
750Li								
760Li								
X1								
D11717286	✓	✓						
D11717286	✓	✓						
D11717286	✓	✓						
D11717286	✓	✓						
D11717286	✓	✓						
X3								
D68374270	✓	✓						
D68374270	✓	✓						
D68374270	✓	✓						
X5								
D68374270	✓	✓						
D10427427	✓	✓						
D10427427	✓	✓						
D68374270	✓	✓						
D68374270	✓	✓						
D10427427	✓	✓						
D10427427	✓	✓						
X6								
D10427427	✓	✓						
D10427427	✓	✓						
D10427427	✓	✓						
Z3								
Z3 M								
CMD39672860	-	✓						
Z4								
D76376310	✓	✓						
D76376310	✓	✓						
D76376310	✓	✓						











		 2012... 2013... 2014...		EJE DELANTERO						
				 PASTILLA			 ROTOR	TIPO	CILINDRO MAESTRO	MEDIDA mm - in
BMW										
Z4 cont.										
Si	L6 3.0L	08-09	D94675920	✓	✓					
23i sDrive	L6 2.5L	10-12	D78178470	✓	✓					
Z4 M										
	L6 3.2L	07-09	D94675920	✓	✓					
BUICK										
ENCLAVE										
		2010	D11698410	✓	✓	BFR137210	Vent	BMC10388 27.0 1 1/16"		
		11-12	D11698410	✓	✓	BFR137210	Vent	BMC10388 27.0 1 1/16"		
		13-15	D11698410	✓	✓	BFR137210	Vent	BMC10388 27.0 1 1/16"		
		16-17	D11698410	✓	✓	BFR137210	Vent			
		18->	CMD18969124	-	✓					
ENCORE										
		14-17	D14678667	✓	✓	BFR231510	Vent	BMC10580 23.8 15/16"		
		18->	CMD20199144	-	✓	BFR231510	Vent	BMC10580 23.8 15/16"		
ENVISION										
		2019								
LACROSSE										
		10-16	D14218536	✓	✓	BFR138510	Vent	BMC10543 25.4 1"		
PARK AVENUE										
		1997	D69975740	✓	-					
REGAL										
		1997	D69975740	✓	-	BFR131810	Vent			
Premium	2.0T	13-14	D14218536	✓	✓			BMC10543 25.4 1"		
GS	2.0T	15-16				BFR138510	Vent	BMC10543 25.4 1"		
		2017								
RIVIERA										
		97-99	D69975740	✓	-					
VERANO										
		13-16	D14678667	✓	✓	BFR139110	Vent	BMC10543 25.4 1"		
CADILLAC										
BLS										
	2.0T	07-08	D97278730	✓	-					
CTS										
suspensión estandar		03-07								
suspensión deportiva		03-07								
CTS-V										
Coupé		12-14								
Sedán	V8	12-13								

		EJE TRASERO						
PASTILLA / ZAPATA			TIPO		MEDIDA mm - in	I / D		
BMW								
Z4 cont.								
D76376310	✓	✓						
Z4 M								
D68374270	✓	✓						
BUICK								
ENCLAVE								
D88377600	✓	✓	BRR134410	Vent				
D15077760	✓	✓	BRR134410	Vent				
D88377600	✓	✓	BRR134410	Vent				
D88377600	✓	✓	BRR134410	Vent				
ENCORE								
D14688668	✓	✓	BRR134610	Sol				
			BRR134610	Sol				
ENVISION								
			BRR136110	(1) Sol			(1) diámetro de 288.0 mm	
LACROSSE								
CMD14308547	—	✓	BRR134710	Vent				
PARK AVENUE								
					WBC50250	22.2 7/8"	D/I	
REGAL								
CMD14308547	—	✓	BRR134710	Vent				
CMD14308547	—	✓	BRR134710	Vent			Frenos Brembo	
CMD14308547	—	✓	BRR134710	Vent			Frenos Brembo	
RIVIERA								
VERANO								
D14688668	✓	✓						
CADILLAC								
BLS								
D10957957	✓	✓						
CTS								
			S78421990	(1)			(1) zapatas de freno de estacionamiento	
D10537958	✓	—						
			S78421990	(1)			(1) zapatas de freno de estacionamiento	
CTS-V								
D10537958	✓	—						
D10537958	✓	—						



		 2012... 2013... 2014...	EJE DELANTERO								
			 PASTILLA			 ROTOR	TIPO	 CILINDRO MAESTRO	MEDIDA mm - in		
CADILLAC											
DE VILLE											
		92-93						BMC10147	25.4	1"	
		97-04	D69975740	✓	—						
EL DORADO											
		1997	D69975740	✓	—						
ESCALADE											
	4X2	2002	D78576530	✓	✓	BFR134410	Vent	BMC10216 ⁽¹⁾	37.0	0.0	
		03-04	D78576530	✓	✓	BFR134410	Vent	BMC10268 ⁽¹⁾	31.7	1 1/4"	
		05-06	D78576530	✓	✓	BFR134410	Vent	BMC10267 ⁽¹⁾	34.0	0.0	
	4X4	2002	D78576530	✓	✓	BFR134410	Vent	BMC10216 ⁽¹⁾	37.0	0.0	
		03-04	D78576530	✓	✓	BFR134410	Vent	BMC10268 ⁽¹⁾	31.7	1 1/4"	
		05-06	D78576530	✓	✓	BFR134410	Vent	BMC10267 ⁽¹⁾	34.0	0.0	
			2007	D10927997	✓	✓	BFR137310	Vent	BMC10327 ⁽¹⁾	31.7	1 1/4"
			2008	D10927997 D13638472	✓ ✓	✓ ✓	BFR137310	Vent	BMC10327 ⁽¹⁾	31.7	1 1/4"
			09-12	D13638472	✓	✓	BFR137310	Vent	BMC10397	31.7	1 1/4"
			13-14	D13638472	✓	✓	BFR137310	Vent	BMC10397	31.7	1 1/4"
			15-20	D13638472	✓	✓	BFR137310	Vent	BMC10567	33.3	1 5/16"
			21->	D21739418	✓	—	BFR232410	Vent			
			2016	CMD19109139	—	✓	BFR137310	Vent	BMC10567	33.3	1 5/16"
ESV		03-06	D78576530	✓	✓	BFR134410	Vent	BMC10282 ⁽¹⁾ BMC10267 ⁽²⁾	34.0 34.0	0.0 0.0	
		07-08	D10927997	✓	✓	BFR137310	Vent	BMC10327	31.7	1 1/4"	
		09-14	D13638472	✓	✓	BFR137310	Vent	BMC10397	31.7	1 1/4"	
		15-20	D13638472	✓	✓	BFR137310	Vent	BMC10567	33.3	1 5/16"	
		21->	D21739418	✓	—	BFR232410	Vent				
EXT		03-06	D78576530	✓	✓	BFR134410	Vent	BMC10282 ⁽¹⁾	34.0		
								BMC10267 ⁽²⁾	34.0		

PASTILLA / ZAPATA		ROTOR / TAMBOR		TIPO	CILINDRO DE RUEDA	MEDIDA mm - in	I / D	
CADILLAC								
DE VILLE								
S63613940					WBC50102	23.8 15/16"	D/I	
EL DORADO								
ESCALADE								
D79276620	✓	✓	BRR131610	Vent				
D83477070	✓	✓	BRR131710	Vent				(1) con frenos HD
			S78121960	(2)				(2) zapatas de freno de estacionamiento
D97478810	✓	✓	BRR131710	Vent				(1) con StabiliTrak®
			S78121960	(2)				(2) zapatas de freno de estacionamiento
D97478810	✓	✓	BRR131710	Vent				(1) con control activo de freno
			S78121960	(2)				(2) zapatas de freno de estacionamiento
D83477070	✓	✓	BRR133410	Vent				(1) con frenos HD
			S78121960	(2)				(2) zapatas de freno de estacionamiento
D83477070	✓	✓	BRR133410	Vent				(1) con StabiliTrak®
			S78121960	(2)				(2) zapatas de freno de estacionamiento
D83477070	✓	✓	BRR133410	Vent				(1) con control activo de freno
			S78121960	(2)				(2) zapatas de freno de estacionamiento
D11948312	✓	✓	BRR133410	Vent				(1) con control activo de freno
			S78121960	(2)				(2) zapatas de freno de estacionamiento
D11948312	✓	✓	BRR133410	Vent				(1) sin control activo de frenos
			S78121960	(2)				(2) zapatas de freno de estacionamiento
D11948312	✓	✓	BRR133410	Vent				(1) zapatas de freno de estacionamiento
			S78121960	(1)				
D11948312	✓	✓	BRR133410	Vent				(1) zapatas de freno de estacionamiento
			S78121960	(1)				
D11948312	✓	✓	BRR133410	Vent				(1) zapatas de freno de estacionamiento
			S10511710	(1)				
D21749419			BRR137110	Vent				
D11948312	✓	✓	BRR133410	Vent				(1) zapatas de freno de estacionamiento
			S10511710	(1)				
D83477070	✓	✓	BRR133410	Vent				(1) sin StabiliTrak®
			S78121960	(3)				(2) con control activo de freno
								(3) zapatas de freno de estacionamiento
D11948312	✓	✓	BRR133410	Vent				(1) zapatas de freno de estacionamiento
			S78121960	(1)				
D11948312	✓	✓	BRR133410	Vent				(1) zapatas de freno de estacionamiento
			S78121960	(1)				
D11948312	✓	✓	BRR133410	Vent				(1) zapatas de freno de estacionamiento
			S10511710	(1)				
D21749419			BRR137110	Vent				
D97478810	✓	✓	BRR131710	Vent				(1) sin StabiliTrak®
			S78121960	(3)				(2) con control activo de freno
								(3) zapatas de freno de estacionamiento



		2012... 2013... 2014...	EJE DELANTERO						MEDIDA mm - in		
			PASTILLA	SM	CM	ROTOR	TIPO	CILINDRO MAESTRO			
CADILLAC											
ESCALADE cont.											
EXT		07-08	D10927997	✓	✓	BFR137310	Vent	BMC10327	31.7	1 1/4"	
		09-13	D13638472	✓	✓	BFR137310	Vent	BMC10397	31.7	1 1/4"	
SEVILLE											
STS		1997	D69975740	✓	-						
		2004	D69975740	✓	-						
STS											
		05-10									
XLR											
		04-06									
XT5											
		17-19	CMD18969124	-	✓						
CHEVROLET											
ASTRA											
	sin ABS	00-01	D15328741	✓	-	BFR133910	Vent	BMC10115 ⁽¹⁾	23.8	15/16"	
	con ABS		D11418252	✓	-	BFR134010	Vent	BMC10117 ⁽²⁾	22.2	7/8"	
	sin ABS	02-03	D15328741	✓	-	BFR133910	Vent	BMC10115 ⁽¹⁾	23.8	15/16"	
	con ABS		D11418252	✓	-	BFR134010	Vent	BMC10117 ⁽²⁾	22.2	7/8"	
		2.4L	04-06	D11418252	✓	-	BFR134010	Vent	BMC10581 ⁽¹⁾	25.4	1"
		2.0L		D15328741	✓	-	BFR133910	Vent	BMC10117 ⁽²⁾	22.2	7/8"
HB	1.8L	06-08	D13618470	✓	-	BFR137910 ⁽¹⁾	Vent	BMC10117 ⁽³⁾	22.2	7/8"	
			D13618470	✓	-	BFR134010 ⁽²⁾	Vent	BMC10581 ⁽⁴⁾	25.4	1"	
	2.0T	06-08	D13618470	✓	-	BFR420510	Vent	BMC10117 ⁽¹⁾	22.2	7/8"	
								BMC10581 ⁽²⁾	25.4	1"	
Sedán		2008	D13618470	✓	-	BFR134010	Vent	BMC10581 ⁽¹⁾	25.4	1"	
Vagoneta		01-03	D11418252	✓	-	BFR134010	Vent	BMC10115 ⁽¹⁾	23.8	15/16"	
AVALANCHE 1500 / 2500											
	4X2	2002	D78576530	✓	✓	BFR134410	Vent	BMC10215 ⁽¹⁾	34.0		
		2003	D78576530	✓	✓	BFR134410	Vent	BMC10268 ⁽¹⁾	31.7	1 1/4"	
								BMC10269 ⁽²⁾	31.7	1 1/4"	
	4X4	2002	D78576530	✓	✓	BFR134410	Vent	BMC10215	34.0		
03-04		D78576530	✓	✓	BFR134410	Vent	BMC10269	31.7	1 1/4"		

		EJE TRASERO							
PASTILLA / ZAPATA			TIPO		CILINDRO DE RUEDA	MEDIDA mm - in	I / D		
CADILLAC									
ESCALADE cont.									
D11948312	✓	✓	BRR133410	Vent					
			S78121960	(1)					(1) zapatas de freno de estacionamiento
D11948312	✓	✓	BRR133410	Vent					
			S78121960	(1)					(1) zapatas de freno de estacionamiento
SEVILLE									
STS									
			S78421990	(1)					(1) zapatas de freno de estacionamiento
XLR									
			S78421990	(1)					(1) zapatas de freno de estacionamiento
XT5									
CHEVROLET									
ASTRA									
D14618661	✓	-	BRR131510	Sol					(1) con 2 puertos > sistema TRW
			BRR131410	Sol					(2) con 4 puertos > sistema Varga
D13628471	✓	-	BRR131510	Sol					(1) con 2 puertos > sistema TRW
			BRR131410	Sol					(2) con 4 puertos > sistema Varga
									(1) con 2 puertos, con ABS
									(2) con 4 puertos sin ABS > sist Varga
D13628471	✓	-							(1) con 4 barrenos
									(2) con 5 barrenos
									(3) con 4 puertos sin ABS > sistema Varga
									(4) con 2 puertos con ABS
D13628471	✓	-	BRR131410	(2) Sol					(1) con 4 puertos sin ABS > sist Varga
									(2) con 2 puertos con ABS
D13628471	✓	-	BRR131410	Sol					(1) con 2 puertos
D13628471	✓	-	BRR131410	Sol					(1) con 4 puertos
AVALANCHE 1500 / 2500									
D97478810	✓	✓	BRR131710	Vent					(1) con booster de vacío
			S78121960	(2)					(2) zapatas de freno de estacionamiento
D97478810	✓	✓	BRR131710	Vent					(1) con StabiliTrak®
			S78121960	(3)					(2) sin StabiliTrak®
									(3) zapatas de freno de estacionamiento
D79276620	✓	✓	BRR131710	Vent					
			S78121960	(1)					(1) zapatas de freno de estacionamiento
D79276620	✓	✓	BRR131710	Vent					
			S78121960	(1)					(1) zapatas de freno de estacionamiento



		2012... 2013... 2014...	EJE DELANTERO							
			PASTILLA	SM	CM	ROTOR	TIPO	CILINDRO MAESTRO	MEDIDA mm - in	
CHEVROLET										
AVALANCHE 1500 / 2500 cont.										
	4X4	05-06	D10927997	✓	✓	BFR137310	Vent	BMC10267	34.0	0.0
	4X2, 4X4	2007	D10927997	✓	✓	BFR137310	Vent	BMC10327	31.7	1 1/4"
	4X4	2008	D13638472	✓	✓	BFR137310	Vent	BMC10327	31.7	1 1/4"
		09-13	D13638472	✓	✓	BFR137310	Vent	BMC10397	31.7	1 1/4"
AVEO										
	1.6L	08-18	D10357779	✓	✓	BFR137410	Vent	BMC10440 ⁽¹⁾	22.2	7/8"
									BMC10500 ⁽²⁾	22.2
								BMC10441 ⁽³⁾	22.2	7/8"
								BMC10442 ⁽⁴⁾	22.2	7/8"
	1.5L	18->	CMD19429167	-	✓	BFR230410	Vent			
BEAT										
		18->	D15908801	✓	✓	BFR230010	Vent			
BLAZER										
	4X2	1991	D1547070A	✓	-	BFR130410	Vent			
		92-93	D1547070A	✓	-	BFR130410	Vent			
		1994	D1547070A	✓	-	BFR130410	Vent	BMC10158	28.5	1 1/8"
		1995	D1547070A	✓	-	BFR130410	Vent	BMC10472	24.0 & 36.0	
		96-97	D1547070A	✓	-	BFR132710	Vent	BMC10170	24.0 & 36.0	
		98-99	D72675930	✓	-	BFR133310	Vent	BMC10197	25.4	1"
		00-01	D72675930	✓	-	BFR133310	Vent	BMC10222	25.4	1"
	4X4	98-99	D72675930	✓	-	BFR133310	Vent	BMC10197	25.4	1"
		19->	CMD18969124	-	✓					
BOLT										
		17-20				BFR139010	Vent			
C10										
		74-78								
		80-87	D0520728A	✓	-	BFR132110	Vent	BMC10475	25.4 & 36.0	0.0
		88-91	D0520728A	✓	-	BFR132110	Vent			
		92-93	D36972590	✓	-	BFR132610	Vent			
								BFR132620 ⁽¹⁾	Vent	

		EJE TRASERO							
PASTILLA / ZAPATA			TIPO			MEDIDA mm - in	I / D		
CHEVROLET									
AVALANCHE 1500 / 2500 cont.									
D79276620	✓	✓	BRR133410 Vent						
			S78121960 (1)						(1) zapatas de freno de estacionamiento
D11948312	✓	✓	BRR133410 Vent						
			S78121960 (1)						(1) zapatas de freno de estacionamiento
D11948312	✓	✓	BRR133410 Vent						
			S78121960 (1)						(1) zapatas de freno de estacionamiento
D11948312	✓	✓	BRR133410 Vent						
			S78121960 (1)						(1) zapatas de freno de estacionamiento
AVEO									
S81415470			BRD133710	WBC50210	19.1	3/4"	D/I		(1) T/A con ABS (2) T/A sin ABS (3) T/M con ABS (4) T/M sin ABS
S10901737			BRD134410	WBC50368	19.1	3/4"	D/I		
BEAT									
S81415470				WBC50364	19.1	3/4"	D/I		
BLAZER									
S51421170			BRD131610	WBC50193	30.1	1 3/16"	D/I		
S51421170			BRD131610						
S51421170			BRD131610	WBC50268	22.2	7/8"	D/I		
S51421170			BRD131610	WBC50268	22.2	7/8"	D/I		
D72975960	✓	-	BRR131210 Vent						
			S78421990 (1)						(1) zapatas de freno de estacionamiento
D72975960	✓	-	BRR131210 Vent						
			S78421990 (1)						(1) zapatas de freno de estacionamiento
D72975960	✓	-							
			S78421990 (1)						(1) zapatas de freno de estacionamiento
BOLT									
C10									
				WBC50209	25.4	1"	D/I		
				WBC50260	28.5	1 1/8"	D/I		
				WBC50193	30.1	1 3/16"	D/I		
			BRD131410	WBC50193	30.1	1 3/16"	D/I		(1) incluye baleros cónicos



		2012... 2013... 2014...	EJE DELANTERO							
			PASTILLA	SM	CM	ROTOR	TIPO	CILINDRO MAESTRO	MEDIDA mm - in	
CHEVROLET										
C15										
	L6	80-87	D0520728A	✓	—	BFR132110	Vent	BMC10475	25.4 & 36.0	
		88-92	D0520728A	✓	—	BFR132110	Vent	BMC10482 ⁽¹⁾	28.5	1 1/8"
C15 / Hunter	V8	82-87	D36872590	✓	—	BFR132510	Vent	BMC10475	25.4 & 36.0	
		88-91	D36872590	✓	—	BFR132510	Vent			
		92-93	D36972590	✓	—	BFR132610 BFR132620 ⁽¹⁾	Vent Vent			
		1994	D36972590	✓	—	BFR132610 BFR132620 ⁽¹⁾	Vent Vent	BMC10158	28.5	1 1/8"
		1995	D36972590	✓	—	BFR132910 BFR132920 ⁽¹⁾	Vent Vent	BMC10158	28.5	1 1/8"
C1500 / C2500										
	sin ABS	94-99	D36972590	✓	—	BFR132610	Vent	BMC10158	28.5	1 1/8"
	con ABS					BFR132620 ⁽¹⁾	Vent			
						BFR132910	Vent			
						BFR132920 ⁽¹⁾	Vent			
C20										
		81-87						BMC10454 ⁽¹⁾	28.6	& 40.0
								BMC10455 ⁽²⁾	31.7	1 1/4"
		1988						BMC10482	28.5	1 1/8"
		89-91	D36972590	✓	—			BMC10482 ⁽¹⁾	28.5	1 1/8"
									BMC10483 ⁽²⁾	31.7
		92-93	D36972590	✓	—	BFR132610	Vent	BMC10482 ⁽¹⁾	28.5	1 1/8"
				—	—	BFR132620 ⁽³⁾	Vent	BMC10483 ⁽²⁾	31.7	1 1/4"
C30										
		74-79								
		80-87	D0520728A	✓	—			BMC10462 ⁽¹⁾	33.3	15/16"
		88-89	D0520728A	✓	—			BMC10483 ⁽¹⁾	31.7	1 1/4"

EJE TRASERO								i	
PASTILLA / ZAPATA	SM	CM	ROTOR / TAMBOR	TIPO	CILINDRO DE RUEDA	MEDIDA mm - in	I / D		
CHEVROLET									
C15									
					WBC50260 ⁽²⁾	28.5	1 1/8"	D/I	(1) con tambor de 11" (2) con cabina-chasis estándar (3) con cabina estándar, extendida y chasis HD
					WBC50193 ⁽³⁾	30.1	1 3/16"	D/I	
S59314040			BRD131410						
S59314040			BRD131410		WBC50260 ⁽¹⁾	28.5	1 1/8"	D/I	(1) con chasis-cabina estándar (2) chasis HD con cabina estándar o extendida
					WBC50193 ⁽²⁾	30.1	1 3/16"	D/I	
S6751404A			BRD131410		WBC50193	30.1	1 3/16"	D/I	(1) incluye baleros cónicos
S6751404A			BRD131410		WBC50193	30.1	1 3/16"	D/I	(1) incluye baleros cónicos
S6751404A			BRD131410		WBC50193	30.1	1 3/16"	D/I	(1) incluye baleros cónicos
C1500 / C2500									
S47320730			BRD131910		WBC50193	30.1	1 3/16"	D/I	(1) incluye baleros cónicos
S6751404A			BRD131410						
C20									
					WBC50209 ⁽¹⁾	25.4	1"	D/I	(1) con tambor de 11"
					WBC50229 ⁽²⁾	26.9	1 1/16"	D/I	(2) con tambor de 13"
					WBC50258	25.4	1"	D/I	
					WBC50258 ⁽¹⁾	25.4	1"	D/I	(1) con tambor de 11"
					WBC50229 ⁽²⁾	26.9	1 1/16"	D/I	(2) con tambor de 13"
					WBC50258 ⁽¹⁾	25.4	1"	D/I	(1) con tambor de 11"
					WBC50229 ⁽²⁾	26.9	1 1/16"	D/I	(2) con tambor de 13"
									(3) incluye baleros cónicos
C30									
					WBC50229 ⁽¹⁾	26.9	1 1/16"	D/I	(1) con tambor de 13" x 2 1/2"
					WBC50231 ⁽²⁾	30.1	1 3/16"	D/I	(2) con tambor de 13" x 3 1/2"
S45120420					WBC50229 ⁽²⁾	26.9	1 1/16"	D/I	(1) con cilindro original Moraine
					WBC50231 ⁽³⁾	30.1	1 3/16"	D/I	(2) con rodada sencilla (3) con doble rodada
S45120420					WBC50229 ⁽³⁾	26.9	1 1/16"	D/I	(1) con rodada sencilla, excepto 9000 a 9200 lb PBV
					WBC50231 ⁽⁴⁾	30.1	1 3/16"	D/I	(3) con rodada sencilla (4) con doble rodada"



			EJE DELANTERO							
			 PASTILLA			 ROTOR	TIPO	CILINDRO MAESTRO	MEDIDA mm - in	
CHEVROLET										
C30 cont.										
		90-91	D0520728A	✓	—			BMC10483 ⁽¹⁾	31.7	1 1/4"
		92-93	D4597339A D45973390	✓ ✓	— —			BMC10483 ⁽¹⁾	31.7	1 1/4"
C3500 (C35)										
		80-87	D0520728A	✓	—			BMC10462 ⁽¹⁾	33.3	1 5/16"
		88-91	D0520728A	✓	—			BMC10483 ⁽¹⁾	31.7	1 1/4"
		92-93	D4597339A D45973390	✓ ✓	— —			BMC10483 ⁽¹⁾	31.7	1 1/4"
		94-00	D45973390 D37072600	✓ ✓	— —			BMC10165	31.7	1 1/4"
C36		01-10	D78476520	✓	✓	BFR136210	Vent			
C3500 HEAVY DUTY										
		96-00	D38078150	✓	—	BFR133110	Vent	BMC10164	40.0	
		01-06	D38078150	✓	—	BFR133110	Vent	BMC10165	31.7	1 1/4"
CAMARO										
Z-28		98-02								
LT	V6	10-15				BFR138510	Vent			
	2.0T	16-18								
RS	V6	16-19								
SS	V8 6.2L	10->								
ZL1	V8 580 hp	13-15								
CAPRICE										
		78-83	D0520728A	✓	—					
CAPTIVA SPORT										
		08-15	CMD16788907	—	✓	BFR137110	Vent	BMC10387	25.4	1"
CAVALIER / Z24										
		90-91		—	—					
		92-94	D50673850	✓	—	BFR131110	Vent			
		1995	D50673850	✓	—	BFR131110	Vent	BMC10163	22.2	7/8"
		96-99	D67375540	✓	—	BFR131110	Vent	BMC10163	22.2	7/8"







PASTILLA / ZAPATA		ROTOR / TAMBOR		TIPO	CILINDRO DE RUEDA	MEDIDA mm - in		I / D	i
CHEVROLET									
C30 cont.									
S45221570					WBC50229 ⁽²⁾	26.9	1 1/16"	D/I	(1) excepto 9000 a 9200 lb PBV
					WBC50231 ⁽³⁾	30.1	1 3/16"	D/I	(2) con rodada sencilla (3) con doble rodada
S45221570					WBC50229 ⁽²⁾	26.9	1 1/16"	D/I	(1) excepto 9000 a 9200 lb PBV
					WBC50231 ⁽³⁾	30.1	1 3/16"	D/I	(2) con rodada sencilla (3) con doble rodada
C3500 (C35)									
S45120420					WBC50229 ⁽²⁾	26.9	1 1/16"	D/I	(1) con cilindro original Moraine
					WBC50231 ⁽³⁾	30.1	1 3/16"	D/I	(2) con rodada sencilla (3) con doble rodada
S45120420					WBC50229 ⁽²⁾	26.9	1 1/16"	D/I	(1) excepto 9000 a 9200 lb PBV
					WBC50231 ⁽³⁾	30.1	1 3/16"	D/I	(2) con rodada sencilla (3) con doble rodada
S45221570					WBC50229 ⁽²⁾	26.9	1 1/16"	D/I	(1) excepto 9000 a 9200 lb PBV
					WBC50231 ⁽³⁾	30.1	1 3/16"	D/I	(2) con rodada sencilla (3) con doble rodada
S45221570					WBC50229 ⁽¹⁾	26.9	1 1/16"	D/I	(1) con rodada sencilla
					WBC50231 ⁽²⁾	30.1	1 3/16"	D/I	(2) con doble rodada
D90977880	✓	—	BRR132810 Vent						
			S77121920 ⁽¹⁾						(1) zapatas de freno de estacionamiento
C3500 HEAVY DUTY									
D38078150	✓	—	BRR131010 Vent						
			S64620860 ⁽¹⁾						(1) zapatas de freno de estacionamiento
D38078150	✓	—	BRR131010 Vent						
			S64620860 ⁽¹⁾						(1) zapatas de freno de estacionamiento
CAMARO									
			S78421990 ⁽¹⁾						(1) zapatas de freno de estacionamiento
			BRR134710 Vent						
			BRR134710 Vent						
D10537958	✓	—							
D10537958	✓	—							
CAPRICE									
					WBC50208	23.8	15/16"	D/I	
CAPTIVA SPORT									
D12758391	✓	✓	BRR133710 Vent						
CAVALIER / Z24									
S55321640			BRD130310						
S55321640			BRD130310		WBC50257	17.4	11/16"	D/I	
S55321640			BRD130310		WBC50257	17.4	11/16"	D/I	
S55321640			BRD130310		WBC50257	17.4	11/16"	D/I	



		2012... 2013... 2014...	EJE DELANTERO							
			PASTILLA	SM	CM	ROTOR	TIPO	CILINDRO MAESTRO	MEDIDA mm - in	
CHEVROLET										
CAVALIER / Z24 cont.										
		00-02	D67375540	✓	—	BFR131110	Vent	BMC10232	22.2	7/8"
		03-04	D67375540	✓	—	BFR131110	Vent	BMC10232	22.2	7/8"
CAVALIER										
	Premier	18-19	CMD19409165	—	✓	BFR232310	Vent			
	LS, LT		CMD19409165	—	✓					
		20->	CMD19409165	—	✓	BFR232310	Vent			
CELEBRITY										
		82-86						BMC10460	22.2	7/8"
		87-89						BMC10473	22.2	7/8"
								BMC10474	24.0	
CENTURY										
		83-86						BMC10460	22.2	7/8"
		87-89						BMC10473	22.2	7/8"
								BMC10474	24.0	
		1990						BMC10474	24.0	
		91-92	D21571360	✓	—			BMC10474	24.0	
		1993	D21571360	✓	—			BMC10474	24.0	
		94-96	D21571360	✓	—			BMC10144	24.0	
CHEVELLE										
		79-81								
CHEVY										
		94-12	D68875630	✓	✓	BFR133410	Vent	BMC10106	20.6	13/16"
CHEVY PICK UP										
		99-03	D11738284	✓	✓	BFR133410	Vent	BMC10116	20.6	13/16"
CITATION / X-11										
		80-82								
		83-86						BMC10460	22.2	7/8"
COLORADO										
		04-08	D10397943	✓	—	BFR135610	Vent	BMC10283	25.4	1"
		09-12	D11698282	✓	✓	BFR138210	Vent	BMC10401	27.0	1 1/16"
		13-15	D16778906	✓	✓	BFR230110	Vent	BMC10572	22.2	7/8"
		16-20	CMD18029034	—	✓	BFR231310	Vent			
CORSA										
		02-05	D11768290	✓	✓	BFR134310	Vent	BMC10111	22.2	7/8"
		06-08	D11768290	✓	✓	BFR134310	Vent	BMC10497	22.2	7/8"
CORVETTE										
		97-13								

PASTILLA / ZAPATA		SM CM		ROTOR / TAMBOR	TIPO	CILINDRO DE RUEDA	MEDIDA mm - in		I / D	i
CHEVROLET										
CAVALIER / Z24 cont.										
S55321640				BRD130310		WBC50257	17.4	11/16"	D/I	
S79515350										
CAVALIER										
CMD19399164	-	✓								
						WBC50363	19.1	3/4"	D/I	
CMD19399164	-	✓								
CELEBRITY										
						WBC50238	17.4	11/16"	D/I	
						WBC50238	17.4	11/16"	D/I	
						WBC50257 ⁽¹⁾	17.4	11/16"	D/I	⁽¹⁾ con tambor de 200.0 mm
CENTURY										
						WBC50238	17.4	11/16"	D/I	
						WBC50238	17.4	11/16"	D/I	
						WBC50257 ⁽¹⁾	17.4	11/16"	D/I	⁽¹⁾ con tambor de 200.0 mm
						WBC50257	17.4	11/16"	D/I	
S63613940				BRD130610		WBC50257	17.4	11/16"	D/I	
S63613940				BRD130610		WBC50250	22.2	7/8"	D/I	
S63613940				BRD130610		WBC50250	22.2	7/8"	D/I	
CHEVELLE										
						WBC50245	19.1	3/4"	D/I	
CHEVY										
S99416650				BRD132510 BRD132520 ⁽¹⁾		WBC50101	19.1	3/4"	D/I	⁽¹⁾ incluye baleros cónicos
CHEVY PICK UP										
S00015100				BRD132310		WBC50107	22.2	7/8"	Izq	
						WBC50106	22.2	7/8"	Der	
CITATION / X-11										
						WBC50238	17.4	11/16"	D/I	
						WBC50238	17.4	11/16"	D/I	
COLORADO										
S81515480				BRD133610		WBC50177	23.8	15/16"	D/I	
S95916430				BRD133610		WBC50199	23.8	15/16"	D/I	
S10161685				BRD133610		WBC50349	23.8	15/16"	D/I	
CMD18069041	-	✓		BRR136310	Vent					
CORSA										
S99416650				BRD130810 BRD130820 ⁽¹⁾		WBC50101	19.1	3/4"	D/I	⁽¹⁾ con balero incluido
S99416650				BRD130810		WBC50101	19.1	3/4"	D/I	
CORVETTE										
				S78421990 ⁽¹⁾						⁽¹⁾ zapatas de freno de estacionamiento



		 2012... 2013... 2014...	EJE DELANTERO							
			 PASTILLA			 ROTOR	TIPO	CILINDRO MAESTRO	MEDIDA mm - in	
CHEVROLET										
CORVETTE cont.										
ZR-1		12-13								
Z06		01-04								
CRUZE										
LS		13-16	D15228730	✓	✓	BFR139010	Vent	BMC10543	25.4	1"
			D14978697 ⁽¹⁾	✓	✓					
LT, LTZ		10-15	D14678667	✓	✓	BFR139010	Vent	BMC10543	25.4	1"
		16-18	CMD19299072	—	✓	BFR232210	Vent			
CUTLASS / EUROSPORT										
		87-90						BMC10474	24.0	
		91-92	D21571360	✓	—			BMC10474	24.0	
		1993	D21571360	✓	—			BMC10474	24.0	
		94-96	D21571360	✓	—			BMC10144	24.0	
EIGHTY EIGHT										
		92-94						BMC10147 ⁽¹⁾	25.4	1"
EQUINOX										
		05-06	D91379740	✓	—	BFR135510	Vent	BMC10250	25.4	1"
		07-08	D12648381	✓	✓	BFR137110	Vent	BMC10387	25.4	1"
		16-17	CMD17458971	—	✓	BFR138510	Vent			
		18->	CMD19139144	—	✓	BFR139110	Vent			
EXPRESS										
8 Pasajeros Cargo Van 1500/ 2500		99-02	D36972590	✓	—	BFR132910	Vent	BMC10178	28.5	1 1/8"
						BFR132920 ⁽¹⁾	Vent			
		03-07	D78576530	✓	✓	BFR134410	Vent	BMC10282	34.0	0.0
		2008	D78576530	✓	✓	BFR134410	Vent	BMC10399 ⁽³⁾	34.0	0.0
		09-11	D13638472	✓	✓	BFR137310	Vent	BMC10430 ⁽³⁾ BMC10429 ⁽⁴⁾	33.3	1 5/16"
	12-15	D13638472	✓	✓	BFR137310	Vent	BMC10429 ⁽³⁾	33.3	1 5/16"	

PASTILLA / ZAPATA				ROTOR / TAMBOR	TIPO	CILINDRO DE RUEDA	MEDIDA mm - in		I / D	
CHEVROLET										
CORVETTE cont.										
				S78421990	(1)					(1) zapatas de freno de estacionamiento
				S78421990	(1)					(1) zapatas de freno de estacionamiento
CRUZE										
S10411663				BRD134110		WBC50207	20.6	13/16"	D/I	(1) Europeo hasta 2012
D14688668	✓	✓		BRR134610	Sol					
CUTLASS / EUROSPORT										
						WBC50257	17.4	11/16"	D/I	
						WBC50257	17.4	11/16"	D/I	
S63613940				BRD130610		WBC50250	22.2	7/8"	D/I	
S63613940				BRD130610		WBC50250	22.2	7/8"	D/I	
EIGHTY EIGHT										
S63613940				BRD130610		WBC50102	23.8	15/16"	D/I	(1) unicamente 92-93
						WBC50142	20.6	13/16"	D/I	
						WBC50250	22.2	7/8"	D/I	
EQUINOX										
S78015000						WBC50168	22.2	7/8"	D/I	
D12758391	✓	✓		BRR133710	Vent					
D12758391	✓	✓		BRR135410	Vent					
				BRR136110	Sol					
EXPRESS										
S47320730				BRD131910		WBC50284	23.8	15/16"	D/I	(1) incluye baleros cónicos
D97478810	(1)	✓	✓	BRR131710	Vent					(1) espesor de 17 mm
D97478750	(2)	✓	✓	S78121960	(3)					(2) espesor de 20 mm
										(3) zapatas de freno de estacionamiento
D97478810	(1)	✓	✓	BRR131710	Vent					(1) espesor de 17 mm
D97478750	(2)	✓	✓	S78121960	(4)					(2) espesor de 20 mm
										(3) sin StabiliTrak®
										(4) zapatas de freno de estacionamiento
D97478810	(1)	✓	✓	BRR131710	Vent					(1) espesor de 17 mm
D97478750	(2)	✓	✓	S78121960	(5)					(2) espesor de 20 mm
										(3) sin StabiliTrak®
										(4) con StabiliTrak®
										(5) zapatas de freno de estacionamiento
D97478810	(1)	✓	✓	BRR131710	Vent					(1) espesor de 17 mm
D97478750	(2)	✓	✓	S78121960	(4)					(2) espesor de 20 mm
										(3) con StabiliTrak®
										(4) zapatas de freno de estacionamiento



			EJE DELANTERO						MEDIDA mm - in	
			PASTILLA	SM	CM	ROTOR	TIPO	CILINDRO MAESTRO		
CHEVROLET										
EXPRESS cont.										
Cargo Van 2500	16-17	D78476520	✓	✓	BFR136210	Vent	BMC10403 ⁽³⁾	38.1	1 1/2"	
							BMC10402 ⁽⁴⁾	38.1	1 1/2"	
	18->	D78476520	✓	✓	BFR136210	Vent	BMC10402 ⁽¹⁾	38.1	1 1/2"	
15 Pasajeros Cargo Van 3500	98-00	D37072600	✓	-	BFR133010	Vent	BMC10179	31.7	1 1/4"	
	01-02	D4597339A	✓	-			BMC10179	31.7	1 1/4"	
	03-07	D78476520	✓	✓			BMC10275 ⁽¹⁾	37.0		
							BMC10345 ⁽²⁾	37.0		
	2008	D78476520	✓	✓			BMC10365 ⁽¹⁾	37.0		
						BMC10400 ⁽²⁾	37.0			
09-15	D78476520	✓	✓			BMC10402 ⁽¹⁾	38.1	1 1/2"		
						BMC10403 ⁽²⁾	38.1	1 1/2"		
12 y 15 Pasajeros	16-17	D78476520	✓	✓			BMC10402 ⁽¹⁾	38.1	1 1/2"	
							BMC10403 ⁽²⁾	38.1	1 1/2"	
	18->	D78476520	✓	✓	BFR136210	Vent	BMC10402 ⁽¹⁾	38.1	1 1/2"	
HHR										
	06-07	D11608270	✓	✓	BFR137510	Vent	BMC10439 ⁽¹⁾	23.8	15/16"	
							BMC10438 ⁽²⁾	23.8	15/16"	
	2008	D11608270	✓	✓	BFR132410	Vent	BMC10439 ⁽¹⁾	23.8	15/16"	
							BMC10438 ⁽²⁾	23.8	15/16"	
				BFR137510	Vent	BMC10394 ⁽³⁾	23.8	15/16"		
						BMC10532 ⁽⁴⁾	23.8	15/16"		
2009	D11608270	✓	✓	BFR132410	Vent	BMC10532 ⁽²⁾	23.8	15/16"		
				BFR137510	Vent	BMC10394 ⁽¹⁾	23.8	15/16"		
IMPALA										
	71-75	D0520728A	✓	-						
	79-80	D0520728A	✓	-						
	00-03	D69975740	✓	-			BMC10192 ⁽¹⁾	25.4	1"	
KODIAK										
	98-01	D22471410	✓	-	BFR134510	Vent				
	01-07	D22471410	✓	-						
LUMINA										
	95-96									
LUV										
	97-05	D36373470	✓	-	BFR133610	Vent	BMC10576	25.4	1"	
MALIBU CHEVELLE										
	78-81	D1547070A	✓	-			BMC10140	23.8	15/16"	

EJE TRASERO								i
PASTILLA / ZAPATA	SM	CM	ROTOR / TAMBOR	TIPO	CILINDRO DE RUEDA	MEDIDA mm - in	I / D	
CHEVROLET								
EXPRESS cont.								
D97478750	✓	✓	BRR132510 ⁽¹⁾	Vent				(1) con 91.0 mm de alto (2) sin StabiliTrak® (3) con StabiliTrak®
D97478750	✓	✓						(1) con StabiliTrak®
S45221570					WBC50258 ⁽¹⁾	25.4 1"	D/I	(1) con rodada sencilla
					WBC50231 ⁽²⁾	30.1 1 3/16"	D/I	(2) con doble rodada
S45221570					WBC50258	25.4 1"	D/I	
D97478750	✓	✓	BRR132510 ⁽³⁾	Vent				(1) sin StabiliTrak® (2) con StabiliTrak® (3) altura de 91 mm
D97478750	✓	✓	BRR132510 ⁽³⁾	Vent				(1) sin StabiliTrak® (2) con StabiliTrak® (3) altura de 91 mm
D97478750	✓	✓	BRR132510	Vent				(1) con StabiliTrak® (2) sin StabiliTrak® (3) altura de 91 mm
D97478750	✓	✓	BRR132510 ⁽³⁾	Vent				(1) con StabiliTrak® (2) sin StabiliTrak® (3) altura de 91 mm
D97478750	✓	✓						(1) con StabiliTrak®
HHR								
S86015350			BRD131510		WBC50191	20.6 13/16"	D/I	(1) T/A (2) T/M
D10337937	✓	✓	BRR132610	Sol				(1) T/A, sin StabiliTrak® (2) T/M, sin StabiliTrak®
S86015350			BRD131510		WBC50191	20.6 13/16"	D/I	(3) T/A, con StabiliTrak® (4) T/M, con StabiliTrak®
D10337937	✓	✓	BRR132610	Sol				(2) T/M
S86015350			BRD131510		WBC50191	20.6 13/16"	D/I	(1) T/A
IMPALA								
S51421170					WBC50208	23.8 15/16"	D/I	
S51421170								(1) con ABS
KODIAK								
D22471410	✓	-	BRR130310	Vent				
D22471410	✓	-						
LUMINA								
S63613940								con tambor trasero
LUV								
S61913600			BRD132410		WBC50244	22.2 7/8"	D/I	
MALIBU CHEVELLE								
S51421170								



		2012... 2013... 2014...	EJE DELANTERO							
			PASTILLA	SM	CM	ROTOR	TIPO	CILINDRO MAESTRO	MEDIDA mm - in	
CHEVROLET										
MALIBU										
	L4	97-99	D72775940	✓	—	BFR131710	Vent	BMC10185	25.4	1"
		00-01	D72775940	✓	—	BFR131710	Vent	BMC10235	23.8	15/16"
		04-06	D10287932	✓	✓	BFR136410	Vent	BMC10299	23.8	15/16"
		2007	D11608270	✓	✓	BFR136410	Vent	BMC10299	23.8	15/16"
		09-12	D11608270	✓	✓	BFR132410	Vent	BMC10405	23.8	15/16"
	2.5L	13-15	D14218536	✓	✓	BFR136010	Vent	BMC10543	25.4	1"
	2.0T	13-18	D14218536	✓	✓	BFR138510	Vent	BMC10543	25.4	1"
	1.5T	16-18	CMD19139144	—	✓	BFR139110	Vent			
	V6	97-99	D72775940	✓	—	BFR131710	Vent	BMC10185	25.4	1"
		00-03	D72775940	✓	—	BFR131710	Vent	BMC10235	23.8	15/16"
		04-05	D10287932	✓	✓	BFR132410	Vent	BMC10299	23.8	15/16"
		06-07	D11608270	✓	✓	BFR132410	Vent	BMC10299	23.8	15/16"
		2008	D11608270	✓	✓	BFR132410	Vent	BMC10299 ⁽¹⁾ BMC10404 ⁽²⁾ BMC10405 ⁽³⁾	23.8 23.8 23.8	15/16" 15/16" 15/16"
	09-12	D11608270	✓	✓	BFR132410	Vent	BMC10405 ⁽¹⁾	23.8	15/16"	
	MATIZ									
		04-05	D13218433	✓	✓	BFR134810	Sol	BMC10503	20.6	13/16"
		06-08	D13218433	✓	✓	BFR134810	Sol	BMC10503	20.6	13/16"
		09-15	D13218433	✓	✓	BFR134810	Sol	BMC10564	20.6	13/16"
MERIVA										
		04-07	D11898308	✓	—	BFR134310	Vent	BMC10119	23.8	15/16"
		07-08	D11898308	✓	—	BFR139610	Vent			
MICROBUS										
		88-90	D0520728A	✓	—	BFR133010	Vent	BMC10462 ⁽¹⁾	33.3	1 5/16"
		91-96	D14970810	✓	—			BMC10462 ⁽¹⁾	33.3	1 5/16"
		97-00	D14970810	✓	—			BMC10165	31.7	1 1/4"
MONTECARLO										
		78-80	D1547070A	✓	—	BFR130410	Vent	BMC10140	23.8	15/16"
		81-84				BFR130410	Vent			
ONIX										
		21->	CMD23859611	—	✓					
OPTRA										
		06-09	D10357779	✓	✓	BFR136510	Vent	BMC10509 ⁽¹⁾	23.8	15/16"
								BMC10514 ⁽²⁾	23.8	15/16"
								BFR137410 ⁽³⁾	Vent	BMC10514 ⁽³⁾
		2010	D10357779	✓	✓	BFR136510	Vent	BMC10509 ⁽¹⁾ BMC10514 ⁽²⁾	23.8 23.8	15/16" 15/16"

		EJE TRASERO						
PASTILLA / ZAPATA			TIPO		MEDIDA mm - in		I / D	
CHEVROLET								
MALIBU								
			BRD130610		WBC50143	22.2	7/8"	D/I
			BRD130610		WBC50143	22.2	7/8"	D/I
S86015350			BRD131510		WBC50192	22.2	7/8"	D/I
S86015350			BRD131510		WBC50192	22.2	7/8"	D/I
D10337937	✓	✓	BRR132610	Sol				
CMD14308547	—	✓	BRR134110	Sol				
CMD14308547	—	✓	BRR134710	Vent				
			BRR136110	Sol				
			BRD130610		WBC50143	22.2	7/8"	D/I
			BRD130610		WBC50143	22.2	7/8"	D/I
D10337937	✓	✓	BRR132610	Sol				
D10337937	✓	✓	BRR132610	Sol				
D10337937	✓	✓	BRR132610	Sol				(1) 3.5L y 3.6L con StabiliTrak® (2) con StabiliTrak® y puertos de 13 x 1.5 mm (3) con puertos de 14 x 1.5 mm
D10337937	✓	✓	BRR132610	Sol				(1) con puertos de 14 x 1.5 mm
MATIZ								
S99516660					WBC50114	17.4	11/16"	D/I
S99516660			BRD133410 BRD133420 (1)		WBC50114	17.4	11/16"	D/I (1) incluye baleros cónicos
S99516660			BRD133410 BRD133420 (1)		WBC50114	17.4	11/16"	D/I (1) incluye baleros cónicos
MERIVA								
S75115160			BRD131210		WBC50101	19.1	3/4"	D/I
D13628471	✓	—						
MICROBUS								
S45120420					WBC50231	30.1	1 3/16"	D/I (1) con tambor de 13" x 3 1/2"
S45221570					WBC50231	30.1	1 3/16"	D/I (1) con tambor de 13" x 3 1/2"
S45221570					WBC50231	30.1	1 3/16"	D/I
MONTECARLO								
S51421170								
S51421170					WBC50245	19.1	3/4"	D/I
ONIX								
OPTRA								
D10367939	✓	✓	BRR133610	Sol				(1) T/A (2) T/M
S74015080					WBC50210	19.1	3/4"	D/I (3) con tambor trasero
D13157939	✓	—	BRR133610	Sol				(1) T/A (2) T/M



				EJE DELANTERO				TIPO	CILINDRO MAESTRO	MEDIDA mm - in	
				PASTILLA	SM	CM	ROTOR				
CHEVROLET											
P30											
		80-81	D14970810	✓	—						
		82-83	D14970810	✓	—						
		84-91	D14970810	✓	—			BMC10462	33.3	1 5/16"	
		92-94	D4597339A ⁽¹⁾	✓	—			BMC10462	33.3	1 5/16"	
			D45973390 ⁽²⁾	✓	—						
		95-96	D37072600	✓	—			BMC10462	33.3	1 5/16"	
			D45973390	✓	—						
		97-00	D37072600	✓	—			BMC10165	31.7	1 1/4"	
			D45973390	✓	—						
		01-03	D78476520	✓	✓						
S10											
		1995	D1547070A	✓	—	BFR130410	Vent	BMC10472	24.0	& 36.0	
		96-97	D1547070A	✓	—	BFR132710	Vent	BMC10472	24.0	& 36.0	
		98-99	D1547070A	✓	—	BFR134610	Vent	BMC10197	25.4	1"	
		00-02	D1547070A	✓	—	BFR134610	Vent	BMC10222	25.4	1"	
		2003	D1547070A	✓	—	BFR134610	Vent	BMC10222	25.4	1"	
		16-17	D16778906	✓	✓	BFR230110	Vent				
SILHOUETTE											
		1991	D21571360	✓	—			BMC10474	24.0		
		92-96									
SILVERADO 1500 / 2500 / CHEYENNE											
		00-02	D78576530	✓	✓	BFR134410 ⁽¹⁾	Vent	BMC10215	34.0	0.0	
						BFR132910 ⁽²⁾	Vent				
						BFR132920 ⁽³⁾	Vent				
		2002	D78576530	✓	✓	BFR134410	Vent	BMC10216 ⁽¹⁾	37.0	0.0	
		2003	D78576530	✓	✓	BFR134410	Vent	BMC10269 ⁽¹⁾	31.7	1 1/4"	
								BMC10275 ⁽²⁾	37.0	0.0	
		2004	D78576530	✓	✓	BFR134410	Vent	BMC10269 ⁽¹⁾	31.7	1 1/4"	
								BMC10268 ⁽²⁾	31.7	1 1/4"	
		05-06	D10927997	✓	✓	BFR137310	Vent	BMC10269 ⁽¹⁾	31.7	1 1/4"	
								BMC10275 ⁽²⁾	37.0	0.0	
								BMC10307 ⁽³⁾	28.5	1 1/8"	
		2007	D10927997	✓	✓	BFR137310	Vent	BMC10327 ⁽¹⁾	31.7	1 1/4"	
								BMC10363 ⁽²⁾	28.5	1 1/8"	







PASTILLA / ZAPATA		ROTOR / TAMBOR		TIPO	CILINDRO DE RUEDA	MEDIDA mm - in		I / D	
CHEVROLET									
P30									
S45221570									
S45221570					WBC50231	30.1	1 3/16"	D/I	
S45221570					WBC50231	30.1	1 3/16"	D/I	
S45221570					WBC50231	30.1	1 3/16"	D/I	(1) con clip Grande (2) con clip chico
S45221570					WBC50231	30.1	1 3/16"	D/I	
S45221570					WBC50231	30.1	1 3/16"	D/I	
D90977880	✓	—							
S10									
S51421170			BRD131610		WBC50279	19.1	3/4"	D/I	
S51421170			BRD131610		WBC50279	19.1	3/4"	D/I	
S51421170			BRD131610		WBC50279	19.1	3/4"	D/I	
S51421170			BRD131610		WBC50279	19.1	3/4"	D/I	
S51421170			BRD131610		WBC50268	22.2	7/8"	D/I	
S10161685			BRD133610		WBC50349	23.8	15/16"	D/I	
SILHOUETTE									
			BRD130610						
S63613940					WBC50194	23.8	15/16"	D/I	
SILVERADO 1500 / 2500 / CHEYENNE									
D79276620	✓	✓	BRR131610	Vent					(1) rotor sin maza (2) rotor con maza (3) incluye baleros cónicos (4) zapatas de freno de estacionamiento
			S78121960	(4)					
D79276620	✓	✓	BRR131610	Vent					(1) Crew Cab (2) zapatas de freno de estacionamiento
			S78121960	(2)					
D79276620	✓	✓	BRR131610	Vent					(1) Extended Cab (2) Crew Cab (3) zapatas de freno de estacionamiento
			S78121960	(3)					
D79276620	✓	✓	BRR131610	Vent					(1) sin StabiliTrak® (2) con StabiliTrak® (3) zapatas de freno de estacionamiento
			S78121960	(3)					
D79276620	✓	✓	BRR131610	Vent					(1) Crew Cab (2) cabina regular y extendida con
			S78121960	(4)					
S85515830			BRD133210		WBC50186	23.8	15/16"	D/I	tuerca central de 3.5 (3) Crew Cab con tuerca central de 4 (4) zapatas de freno de estacionamiento
D79276620	✓	✓	BRR131610	Vent					(1) con StabiliTrak® (2) sin StabiliTrak® (3) zapatas de freno de estacionamiento
			S78121960	(3)					
S85515830			BRD133210		WBC50186	(4) 23.8	15/16"	D/I	(4) 6400 lb PBV



			EJE DELANTERO						MEDIDA mm - in	
			PASTILLA			ROTOR	TIPO	CILINDRO MAESTRO		
CHEVROLET										
SILVERADO 1500 / 2500 / CHEYENNE cont.										
		2008	D13638472	✓	✓	BFR137310	Vent	BMC10327 ⁽¹⁾	31.7	1 1/4"
								BMC10363 ⁽²⁾	28.5	1 1/8"
		09-14	D13638472	✓	✓	BFR137310	Vent	BMC10396 ⁽¹⁾	28.5	1 1/8"
								BMC10397 ⁽²⁾	31.7	1 1/4"
		15-18	D13638472	✓	✓	BFR137310	Vent	BMC10567	33.3	1 5/16"
		19->	D21739418	✓	—	BFR232410	Vent			
SILVERADO 3500 (C36)										
		00-02	D78476520	✓	✓	BFR136210	Vent	BMC10216	37.0	
		03-06	D78476520	✓	✓	BFR136210	Vent	BMC10275	37.0	
		07-08	D78476520	✓	✓	BFR136210	Vent	BMC10365 ⁽¹⁾	37.0	
								BMC10364 ⁽²⁾	37.0	
		09-10	D78476520	✓	✓	BFR136210	Vent			
		11-18	D14118523	✓	—	BFR139410	Vent			
SONIC										
		12-17	D17028926	✓	✓	BFR139910	Vent	BMC10317	22.2	7/8"
RS	1.4T	14-16	D15228730	✓	✓	BFR139010	Vent			
SONORA										
		00-02	D78576530	✓	✓	BFR134410	Vent	BMC10215	34.0	
		2003	D78576530	✓	✓	BFR134410	Vent	BMC10282 ⁽¹⁾	34.0	
								BMC10268 ⁽²⁾	31.7	1 1/4"
		2004	D78576530	✓	✓	BFR134410	Vent	BMC10282 ⁽³⁾	34.0	
								BMC10268 ⁽⁴⁾	31.7	1 1/4"
		2005	D78576530	✓	✓	BFR134410	Vent	BMC10267	34.0	
		2006	D78576530	✓	✓	BFR134410	Vent	BMC10267	34.0	
SPARK										
Classic	1.2L	11-17	D15908801	✓	✓	BFR230010	Vent	BMC10583 ⁽¹⁾	22.2	7/8"
LT	1.4L	16-18	CMD20249254	—	✓	BFR231410	Vent			
		19->	CMD18649093	—	✓	BFR231410	Vent			
EV		2015	D10357779	✓	✓	BFR137410	Vent			
SUBURBAN										
		84-89	D0520728A	✓	—	BFR132110	Vent	BMC10454	28.6	& 40.0

PASTILLA / ZAPATA		ROTOR / TAMBOR		TIPO	CILINDRO DE RUEDA	MEDIDA mm - in		I / D	i
CHEVROLET									
SILVERADO 1500 / 2500 / CHEYENNE cont.									
S85515830			BRD133210		WBC50186 ⁽³⁾	23.8	15/16"	D/I	(1) con StabiliTrak® (2) sin StabiliTrak® (3) 6400 lb PBV
S96016440			BRD134010		WBC50198 ⁽³⁾ WBC50199 ⁽⁴⁾	26.9 23.8	1 1/16" 15/16"	D/I D/I	(1) sin StabiliTrak® (2) con StabiliTrak® (3) 7000 lb PBV (4) 6400 lb PBV
D11948312	✓	✓	BRR133410	Vent					(1) zapatas de freno de estacionamiento
			S10511710	(1)					
D21749419			BRR137110	Vent					
SILVERADO 3500 (C36)									
D78476520	✓	✓	BRR132810	Vent					(1) zapatas de freno de estacionamiento
D90977880	✓	-	S77121920	(1)					
D78476520	✓	✓	BRR132810	Vent					(1) zapatas de freno de estacionamiento
D90977880	✓	-	S77121920	(1)					
D78476520	✓	✓	BRR132810	Vent					(1) sin freno de remolque (2) con freno de remolque (3) zapatas de freno de estacionamiento
D90977880	✓	-	S77121920	(3)					
D78476520	✓	✓	BRR132810	Vent					(1) zapatas de freno de estacionamiento
D90977880	✓	-	S77121920	(1)					
D14118523	✓	-	BRR135210	Vent					(1) zapatas de freno de estacionamiento
			S98916400	(1)					
SONIC									
S81415470			BRD134210		WBC50309	19.1	3/4"	D/I	
D14688668	✓	✓	BRR134610	Sol					
SONORA									
D83477070	✓	✓	BRR131710	Vent					(1) sin StabiliTrak® (2) con StabiliTrak®
D83477070	✓	✓	BRR131710	Vent					
D97478750 ⁽¹⁾	✓	✓	BRR131710	Vent					(1) espesor de 20 mm (2) espesor de 17 mm (3) sin StabiliTrak® (4) con StabiliTrak®
D97478810 ⁽²⁾	✓	✓							
D78576530	✓	✓	BRR131710	Vent					
D83477070	✓	✓	BRR131710	Vent					
D97478810	✓	✓							
SPARK									
S81415470			BRD133710		WBC50210	19.1	3/4"	D/I	(1) sin ABS
SUBURBAN									
S47320730					WBC50208	23.8	15/16"	D/I	



 		EJE DELANTERO									
		 PASTILLA    ROTOR TIPO  CILINDRO MAESTRO MEDIDA mm - in									
CHEVROLET											
SUBURBAN cont.											
	90-91	D36972590	✓	—	BFR132610 BFR132620 ⁽¹⁾	Vent Vent	BMC10454	28.6	& 40.0		
	92-93	D36972590	✓	—	BFR132910 BFR132920 ⁽¹⁾	Vent Vent					
	94-99	D36972590	✓	—	BFR132910 BFR132920 ⁽¹⁾	Vent Vent	BMC10158	28.5	1 1/8"		
	00-02	D78576530	✓	✓	BFR134410	Vent	BMC10215	34.0	0.0		
	03-04	D78576530	✓	✓	BFR134410	Vent	BMC10268 ⁽³⁾ BMC10282 ⁽⁴⁾ BMC10267 ⁽⁵⁾	31.7 34.0 34.0	1 1/4" 0.0 0.0		
	2005	D78576530	✓	✓	BFR134410	Vent	BMC10268 ⁽¹⁾ BMC10267 ⁽²⁾	31.7 34.0	1 1/4" 0.0		
	2006	D78476520	✓	✓	BFR134410	Vent	BMC10268 ⁽¹⁾ BMC10267 ⁽²⁾	31.7 34.0	1 1/4" 0.0		
	07-08	D10927997	✓	✓	BFR137310	Vent	BMC10327 ⁽¹⁾	31.7	1 1/4"		
	09-14	D13638472	✓	✓	BFR137310	Vent	BMC10397	31.7	1 1/4"		
	15-20	D13638472	✓	✓	BFR137310	Vent	BMC10397	31.7	1 1/4"		
21->	D21739418	✓	—	BFR232410	Vent						
TAHOE											
	2007	D10927997	✓	✓	BFR137310	Vent	BMC10327 ⁽¹⁾	31.7	1 1/4"		
	2008	D10927997 D13638472	✓ ✓	✓ ✓	BFR137310	Vent	BMC10327	31.7	1 1/4"		
	09-14	D13638472	✓	✓	BFR137310	Vent	BMC10397	31.7	1 1/4"		
	15-20	D13638472	✓	✓	BFR137310	Vent	BMC10397	31.7	1 1/4"		
	21->	D21739418	✓	—	BFR232410	Vent					
TORNADO											
	04-11	D11768290	✓	✓	BFR134310	Vent	BMC10497	22.2	7/8"		
	11-20	D11768290	✓	✓	BFR134310	Vent	BMC10569	22.2	7/8"		







		EJE TRASERO							
PASTILLA / ZAPATA			ROTOR / TAMBOR	TIPO	CILINDRO DE RUEDA		MEDIDA mm - in	I / D	
CHEVROLET									
SUBURBAN cont.									
S47320730					WBC50208		23.8 15/16"	D/I	(1) incluye baleros cónicos
S47320730			BRD131910		WBC50258		25.4 1"	D/I	(1) incluye baleros cónicos
S47320730			BRD131910		WBC50258		25.4 1"	D/I	(1) incluye baleros cónicos
D83477070	✓	✓	BRR131710 Vent						(1) zapatas de freno de estacionamiento
			S78121960 (1)						
D97478810 (1)	✓	✓	BRR131710 Vent						(1) espesor de 17 mm
D97478750 (2)	✓	✓							(2) espesor de 20 mm"
			S78121960 (6)						(3) 2WD con StabiliTrak®
									(4) sin StabiliTrak®
									(5) 4WD con control activo defreno
									(6) zapatas de freno de estacionamiento
D97478810 (3)	✓	✓	BRR131710 Vent						(1) 2WD
D97478750 (4)	✓	✓							(2) 4WD
			S78121960 (5)						(3) espesor de 17 mm
									(4) espesor de 20 mm
									(5) zapatas de freno de estacionamiento
D78576530	✓	✓	BRR131710 Vent						(1) 2WD
			S78121960 (3)						(2) 4WD
									(3) zapatas de freno de estacionamiento
D11948312	✓	✓	BRR133410 Vent						(1) con control activo de freno
			S78121960 (2)						(2) zapatas de freno de estacionamiento
D11948312	✓	✓	BRR133410 Vent						(1) zapatas de freno de estacionamiento
			S78121960 (1)						
D11948312	✓	✓	BRR133410 Vent						(1) zapatas de freno de estacionamiento
			S10511710 (1)						
D21749419	✓	—	BRR137110 Vent						
TAHOE									
D11948312	✓	✓	BRR133410 Vent						(1) con control activo de freno
			S78121960 (2)						(2) zapatas de freno de estacionamiento
D11948312	✓	✓	BRR133410 Vent						(1) zapatas de freno de estacionamiento
			S78121960 (1)						
D11948312	✓	✓	BRR133410 Vent						(1) zapatas de freno de estacionamiento
			S78121960 (1)						
D11948312	✓	✓	BRR133410 Vent						(1) zapatas de freno de estacionamiento
			S10511710 (1)						
D21749419	✓	—	BRR137110 Vent						
TORNADO									
S75115160			BRD131210		WBC50295		22.2 7/8"	D/I	
S75115160			BRD131210						



		2012... 2013... 2014...	EJE DELANTERO						MEDIDA mm - in		
			PASTILLA	SM	CM	ROTOR	TIPO	CILINDRO MAESTRO			
CHEVROLET											
TRACKER											
2 Puertas		92-95				BFR133710	Sol	BMC10133	⁽¹⁾	22.2	7/8"
		1998				BFR133710	Sol	BMC10133	⁽¹⁾	22.2	7/8"
		1999	D55674350	✓	—			BMC10217	⁽¹⁾	23.8	15/16"
		00-04	D55674350	✓	—	BFR135110	Vent	BMC10240	⁽²⁾	23.8	15/16"
4 Puertas		1998	D55674350	✓	—			BMC10217	⁽¹⁾	23.8	15/16"
		1999	D55674350	✓	—			BMC10240	⁽²⁾	23.8	15/16"
		00-04	D55674350	✓	—	BFR135110	Vent	BMC10217	⁽¹⁾	23.8	15/16"
		05-08	D68073480	✓	—	BFR135110	Vent	BMC10240	⁽²⁾	23.8	15/16"
TRAILBLAZER											
	L6	02-05	D88277590	✓	—	BFR135210	Vent	BMC10239		25.4	1"
	V8					BFR135310	Vent				
	L6	06-07	D11698282	✓	✓			BMC10325		27.0	1 1/16"
	V8										
EXT LS		03-04	D88277590	✓	—	BFR135210	Vent	BMC10239		25.4	1"
		2005	D11698282	✓	✓	BFR135210	Vent				
		2006	D11698282	✓	✓			BMC10325		27.0	1 1/16"
EXT LT		03-04	D88277590	✓	—	BFR135310	Vent	BMC10239		25.4	1"
		05-06	D11698282	✓	✓			BMC10325		27.0	1 1/16"
TRAVERSE											
		09-10	D11698410	✓	✓	BFR137210	Vent	BMC10388		27.0	1 1/16"
		11-17	D11698410	✓	✓	BFR137210	Vent				
		18->	CMD18969124	—	✓						
TRAX											
		13-17	D14678667	✓	✓	BFR231510	Vent	BMC10580		23.8	15/16"
		18-20	CMD20199144	—	✓	BFR231510	Vent				

		EJE TRASERO							
PASTILLA / ZAPATA			TIPO		MEDIDA mm - in		I / D		
CHEVROLET									
TRACKER									
				WBC50267	23.8	15/16"	Izq		
				WBC50266	23.8	15/16"	Der	⁽¹⁾ sin ABS	
				WBC50282	22.2	7/8"	Izq		
				WBC50281	22.2	7/8"	Der	⁽¹⁾ sin ABS	
S73815060				WBC50146	22.2	7/8"	Izq	⁽¹⁾ sin ABS	
				WBC50147	22.2	7/8"	Der	⁽²⁾ con ABS	
S73815060				WBC50157	22.2	7/8"	Izq	⁽¹⁾ sin ABS	
				WBC50156	22.2	7/8"	Der	⁽²⁾ con ABS	
				WBC50282	22.2	7/8"	Izq		
				WBC50281	22.2	7/8"	Der	⁽¹⁾ sin ABS	
S73815060				WBC50146	22.2	7/8"	Izq	⁽¹⁾ sin ABS	
				WBC50147	22.2	7/8"	Der	⁽²⁾ con ABS	
S73815060				WBC50157	22.2	7/8"	Izq	⁽¹⁾ sin ABS	
				WBC50156	22.2	7/8"	Der	⁽²⁾ con ABS	
S73815060				WBC50146	22.2	7/8"	Izq		
				WBC50147	22.2	7/8"	Der		
TRAILBLAZER									
D88377600	✓	✓	BRR131810	Vent					
			S78121960	⁽¹⁾				⁽¹⁾ zapatas de freno de estacionamiento	
D88377600	✓	✓	BRR131810	Vent					
			S78121960	⁽¹⁾				⁽¹⁾ zapatas de freno de estacionamiento	
D88377600	✓	✓	BRR131810	Vent					
			S78121960	⁽¹⁾				⁽¹⁾ zapatas de freno de estacionamiento	
D88377600	✓	✓	BRR131810	Vent					
			S78121960	⁽¹⁾				⁽¹⁾ zapatas de freno de estacionamiento	
D88377600	✓	✓	BRR131810	Vent					
			S78121960	⁽¹⁾				⁽¹⁾ zapatas de freno de estacionamiento	
D88377600	✓	✓	BRR131810	Vent					
			S78121960	⁽¹⁾				⁽¹⁾ zapatas de freno de estacionamiento	
D88377600	✓	✓	BRR131810	Vent					
			S78121960	⁽¹⁾				⁽¹⁾ zapatas de freno de estacionamiento	
TRAVERSE									
D88377600	✓	✓	BRR134410	Vent					
D88377600	✓	✓	BRR134410	Vent					
D15077760	⁽¹⁾	✓						⁽¹⁾ opcional sólo 2011	
TRAX									
S10111680			BRD134310		WBC50350	22.2 7/8"	D/I		
D10937999	✓	-	BRR133110	Sol					



		 2012... 2013... 2014...	EJE DELANTERO								
			 PASTILLA			 ROTOR	TIPO	 CILINDRO MAESTRO	MEDIDA mm - in		
CHEVROLET											
UPLANDER											
		2005	D10757980	✓	✓				BMC10340	25.4	1"
		05-09	D10757980	✓	✓	BFR136910	Vent		BMC10340	25.4	1"
VECTRA											
	L4	02-05	D97278730	✓	—				BMC10118	25.4	1"
	V6		D12578376	✓	—				BMC10118	25.4	1"
		06-08	D12578376	✓	—				BMC10118	25.4	1"
VENTURE											
Corta		97-99	D69975740	✓	—	BFR131810	Vent		BMC10182	25.4	1 1/4"
		00-03	D69975740	✓	—	BFR131810	Vent		BMC10192	25.4	1"
Larga		98-99	D69975740	✓	—	BFR131810	Vent		BMC10182	25.4	1"
		00-04	D69975740	✓	—	BFR131810	Vent		BMC10192	25.4	1"
VOLT											
Eléctrico		16-19				BFR139010	Vent				
ZAFIRA											
	sin ABS	02-05	D15328741	✓	—	BFR133910	Vent		BMC10115	23.8	15/16"
	con ABS		D11418252	✓	—	BFR134010	Vent		BMC10115	23.8	15/16"
		2006	D13618470	✓	—	BFR420510	Vent		BMC10115	23.8	15/16"
400 SS											
		93-96									
		97-02	D78576530	✓	✓	BFR134410	Vent				
		03-07	D78576530	✓	✓	BFR134410	Vent				
CHRYSLER											
ASPEN											
		07-09	D10847991	✓	✓	BFR115310	Vent		BMC10376	31.7	1 1/4"
BREEZE											
		1996	D6507530A	✓	—	BFR111610	Vent				
CIRRUS											
Sedán		96-97	D6507530A	✓	—	BFR110410	Vent				
		98-00	D6507530A	✓	—	BFR110410	Vent				
		01-06	D86977440	✓	✓	BFR110410	Vent		BMC10112	25.4	1"
	L4	07-10	D86677410	✓	✓	BFR111410	Vent		BMC10386	22.2	7/8"
	V6										
Convertible		01-06	D86977440	✓	✓	BFR110410	Vent				
		08-09	D86677410	✓	✓	BFR111410	Vent		BMC10386	22.2	7/8"
		2010	D86677410	✓	✓	BFR111410	Vent		BMC10386	22.2	7/8"

		EJE TRASERO							
PASTILLA / ZAPATA			TIPO		MEDIDA mm - in		I / D		
CHEVROLET									
UPLANDER									
D10937999	✓	—							
D10937999	✓	—	BRR133110	Sol					
VECTRA									
D94078420	✓	✓							
D94078420	✓	✓							
D10957957	✓	✓							
VENTURE									
S63613940			BRD130610		WBC50194	23.8 15/16"	D/I		
S63613940			BRD130610		WBC50194	23.8 15/16"	D/I		
VOLT									
ZAFIRA									
D13628471	✓	—	BRR131510	Sol					
D13628471	✓	—	BRR131410	Sol					
D13628471	✓	—							
400 SS									
S59314040									
D79276620	✓	✓	BRR131610	Vent					
D79276620	✓	✓							
CHRYSLER									
ASPEN									
D96778690	✓	✓	BRR110410	Vent					
BREEZE									
D6417438B	✓	—	BRR110610	Sol					
CIRRUS									
D6417438B	✓	—	BRR110610	Sol					(1) zapatas de freno de estacionamiento
			S64314410 (1)						
D6417438B	✓	—	BRR110610	Sol					(1) zapatas de freno de estacionamiento
			S64314410 (1)						
D6417438B	✓	—	BRR110610	Sol					
D86877430	✓	✓	BRR112210	Sol					
D10377940 (1)	✓	✓	BRR112410	Sol					(1) solo 2007
D6417438B	✓	—	BRR110610	Sol					(1) con control de tracción
			S64314410 (3)						(3) zapatas de freno de estacionamiento
D86877430	✓	✓	BRR112410	Sol					
D10377940	✓	✓	BRR112410	Sol					









				EJE DELANTERO				TIPO	CILINDRO MAESTRO	MEDIDA mm - in
				PASTILLA	SM	CM	ROTOR			
CHRYSLER										
CONCORDE LHS										
		93-94	D5917470A	✓	—					
		95-97	D6427518A	✓	—					
		01-02	D73075970	✓	—			BMC10198 ⁽¹⁾	23.8	15/16"
		2002	D86977440	✓	✓					
CORDOBA										
		80-82								
CROSSFIRE										
		04-05	D85377300	✓	—					
DART										
VER DODGE DART										
INTREPID										
LHS		1994	D5917470A	✓	—					
		95-97	D6427518A	✓	—					
		98-01	D73075970	✓	—			BMC10198	23.8	15/16"
R/T		00-01	D73075970	✓	—			BMC10198	23.8	15/16"
IMPERIAL										
		91-92					BFR110910	Vent		
LE BARON										
		1983	D2207134A	✓	—			BMC10465	21.0	53/64"
		84-85	D2207134A	✓	—			BMC10465	21.0	53/64"
		1986	D2207134A	✓	—	BFR110910	Vent	BMC10467	24.0	0.0
		1987	D2207134A	✓	—	BFR110910	Vent	BMC10467	24.0	0.0
		1991	D5227404A	✓	—	BFR110910	Vent	BMC10101	22.2	7/8"
		92-95	D5227404A	✓	—			BMC10467	24.0	0.0
			D5217403A	✓	—	BFR110910	Vent	BMC10101	22.2	7/8"
LHS										
		95-97	D6427518A	✓	—					
MAGNUM										
		81-82								
		83-85	D2207134A	✓	—					
		86-88	D2207134A	✓	—	BFR110910	Vent			

PASTILLA / ZAPATA		EJE TRASERO		ROTOR / TAMBOR		TIPO	CILINDRO DE RUEDA	MEDIDA mm - in		I / D	i
SM	CM										
CHRYSLER											
CONCORDE LHS											
D6587438A	✓	-		S64314410 (1)							(1) zapatas de freno de estacionamiento
D6587438A	✓	-		S64314410 (1)							(1) zapatas de freno de estacionamiento
D6587438A	✓	-		S64314410 (3)							(1) con ABS (3) zapatas de freno de estacionamiento
D6587438A	✓	-		S64314410 (1)							(1) zapatas de freno de estacionamiento
CORDOBA											
							WBC50221	23.8	15/16"	D/I	
CROSSFIRE											
DART											
INTREPID											
D6587438A	✓	-		S64314410 (1)							(1) zapatas de freno de estacionamiento
D6587438A	✓	-		S64314410 (1)							(1) zapatas de freno de estacionamiento
D6587438A	✓	-		S64314410 (1)							(1) zapatas de freno de estacionamiento
D6587438A	✓	-		S64314410 (1)							(1) zapatas de freno de estacionamiento
IMPERIAL											
							WBC50274	15.8	5/8"	D/I	
LE BARON											
							WBC50239	15.8	5/8"	D/I	
							WBC50241	14.2	9/16"	D/I	
S52013660				BRD111010			WBC50241	14.2	9/16"	D/I	
S52013660				BRD111010			WBC50241	14.2	9/16"	D/I	
S65714440				BRD111010			WBC50274	15.8	5/8"	D/I	
S65714440				BRD111010			WBC50274	15.8	5/8"	D/I	
LHS											
D6587438A	✓	-		S64314410 (1)							(1) zapatas de freno de estacionamiento
MAGNUM											
							WBC50221	23.8	15/16"	D/I	
							WBC50239	15.8	5/8"	D/I	
							WBC50241	14.2	9/16"	D/I	
S52013660				BRD111010			WBC50239	15.8	5/8"	D/I	
							WBC50241	14.2	9/16"	D/I	











		 2012... 2013... 2014...	EJE DELANTERO						 PASTILLA		 ROTOR		 CILINDRO MAESTRO		MEDIDA mm - in	
					TIPO											
CHRYSLER																
NEW YORKER																
	1985	D2207134A	✓	—			BMC10465	21.0	53/64"							
	86-87	D2207134A	✓	—	BFR110910	Vent	BMC10465	21.0	53/64"							
	88-89	D2207134A	✓	—	BFR110910	Vent	BMC10467	24.0	0.0							
	90-94	D5217403A	✓	—	BFR110910	Vent	BMC10467	24.0	0.0							
	92-94	D5227404A	✓	—			BMC10467	24.0	0.0							
LHS	1994	D5917470A	✓	—												
	95-97	D5917470A	✓	—												
PACIFICA																
	2004	D99778980	✓	—			BMC10241 ⁽¹⁾	23.8	15/16"							
							BMC10279 ⁽²⁾	25.4	1"							
	05-06	D99778980	✓	—			BMC10279	25.4	1"							
	07-08	D99778980	✓	—			BMC10550	25.4	1"							
	17->	D15898800	✓	✓	BFR117110	Vent										
PHANTOM																
	87-88	D2207134A	✓	—	BFR110910	Vent	BMC10465	21.0	53/64"							
	1989	D2207134A	✓	—	BFR110910	Vent	BMC10467	24.0								
	1990	D5227404A	✓	—	BFR110910	Vent	BMC10467 ⁽¹⁾	24.0								
							BMC10101 ⁽²⁾	22.2	7/8"							
	1991	D5227404A	✓	—	BFR110910	Vent	BMC10467 ⁽¹⁾	24.0								
						BMC10101 ⁽²⁾	22.2	7/8"								
92-94	D5227404A	✓	—	BFR110910	Vent	BMC10467	24.0									
						BMC10101 ⁽¹⁾	22.2	7/8"								
PT CRUISER																
	01-04	D84177160	✓	✓	BFR113810	Vent	BMC10224	23.8	15/16"							
							BMC10230 ⁽¹⁾	23.8	15/16"							
	05-08	D84177160	✓	✓	BFR113810	Vent	BMC10346	22.2	7/8"							
							BMC10347	22.2	7/8"							
2009	D84177160	✓	✓	BFR113810	Vent											
2010	D84177160	✓	✓	BFR113810	Vent											
Turbo	03-04	D84177160	✓	✓			BMC10224	23.8	15/16"							
	05-07	D84177160	✓	✓			BMC10346	22.2	7/8"							
SEBRING																
	97-00				BFR111610	Vent										
SHADOW																
	89-90	D2207134A	✓	—	BFR110910	Vent	BMC10101	22.2	7/8"							
							BMC10465	21.0	53/64"							







PASTILLA / ZAPATA				ROTOR / TAMBOR	TIPO	CILINDRO DE RUEDA	MEDIDA mm - in		I / D	
CHRYSLER										
NEW YORKER										
						WBC50241	14.2	9/16"	D/I	
S52013660				BRD111010		WBC50241	14.2	9/16"	D/I	
S52013660				BRD111010		WBC50239	15.8	5/8"	D/I	
S65714440				BRD111010		WBC50274	15.8	5/8"	D/I	
				S64314410 ⁽¹⁾						⁽¹⁾ zapatas de freno de estacionamiento
				S64314410 ⁽¹⁾						⁽¹⁾ zapatas de freno de estacionamiento
D6587438A	✓	-		S64314410 ⁽¹⁾						⁽¹⁾ zapatas de freno de estacionamiento
PACIFICA										
D99878990	✓	-								⁽¹⁾ sin control de tracción ⁽²⁾ con control de tracción
D99878990	✓	-								
D99878990	✓	-								
CMD19019128		✓								
PHANTOM										
S52013660				BRD111010		WBC50239	15.8	5/8"	D/I	
S52013660				BRD111010		WBC50239	15.8	5/8"	D/I	
										⁽¹⁾ con rin 15" y 16" ⁽²⁾ con rin 14"
										⁽¹⁾ con rin 15" ⁽²⁾ con rin 14"
										⁽¹⁾ con rin 14"
PT CRUISER										
				BRD111010		WBC50196	19.1	3/4"	D/I	⁽¹⁾ sin ABS
S81015420										
D6587438A	✓	-								
D6587438A	✓	-								
D6587438A	✓	-								
SEBRING										
				BRR110910 Sol						
				S64314410 ⁽¹⁾						⁽¹⁾ zapatas de freno de estacionamiento
SHADOW										
				S64314410						
S52013660				BRD111010		WBC50239	15.8	5/8"	D/I	⁽¹⁾ zapatas de freno de estacionamiento



		 2012... 2013... 2014...	EJE DELANTERO							
			 PASTILLA			 ROTOR	TIPO	CILINDRO MAESTRO	MEDIDA mm - in	
CHRYSLER										
SHADOW cont.										
		91-94	D5217403A	✓	—	BFR110910	Vent	BMC10101	22.2	7/8"
								BMC10465	21.0	53/64"
Turbo		91-94	D5217403A	✓	—	BFR110910	Vent	BMC10101	22.2	7/8"
								BMC10465	21.0	53/64"
SPIRIT										
		1990	D2207134A	✓	—	BFR110910	Vent	BMC10465	21.0	53/64"
		91-95	D5217403A	✓	—	BFR110910	Vent	BMC10101	22.2	7/8"
								BMC10467	24.0	
								BMC10101	22.2	7/8"
R/T		90-95	D5227404A	✓	—			BMC10467	24.0	
TOWN & COUNTRY										
		93-95	D5217403A	✓	—	BFR110910	Vent	BMC10467	24.0	
			D5227404A	✓	—	BFR112610	Vent			
		1996	D6427518A	✓	—	BFR112610	Vent	BMC10162	23.8	15/16"
4 discos		97-00	D5917470A	✓	—	BFR113410	Vent	BMC10162	⁽¹⁾ 23.8	15/16"
2 discos			D6427518A	✓	—			BMC10183	⁽²⁾ 23.8	15/16"
4 discos		01-02	D85777330	✓	✓	BFR114410	Vent	BMC10243	⁽¹⁾ 27.0	1 1/16"
								BMC10242	⁽²⁾ 27.0	1 1/16"
2 discos			D85677320	✓	✓	BFR110110	Vent	BMC10162	23.8	15/16"
		03-05	D85777330	✓	✓	BFR114410	Vent	BMC10241	⁽¹⁾ 23.8	15/16"
								BMC10279	⁽²⁾ 25.4	1"
		06-07	D85777330	✓	✓	BFR114410	Vent	BMC10279	25.4	1"
		2008	D13278439	✓	✓	BFR114810	Vent	BMC10550	25.4	1"
		09-11	D13278439	✓	✓	BFR114810	Vent	BMC10550	25.4	1"
			D12738389	✓	✓					
		12-16	D13278439	⁽¹⁾ ✓	✓	BFR114810	⁽¹⁾ Vent	BMC10550	⁽¹⁾ 25.4	1"
			D12738389	⁽¹⁾ ✓	✓					
			D15898800	⁽²⁾ ✓	✓	BFR117110	⁽²⁾ Vent			
VALIANT										
Duster		70-76								

PASTILLA / ZAPATA		EJE TRASERO		ROTOR / TAMBOR		TIPO	CILINDRO DE RUEDA		MEDIDA mm - in		I / D	i
CHRYSLER												
SHADOW cont.												
				S64314410	(1)							
S52013660				BRD111010			WBC50239	15.8	5/8"	D/I		(1) zapatas de freno de estacionamiento
				S64314410	(1)							
S52013660				BRD111010			WBC50239	15.8	5/8"	D/I		(1) zapatas de freno de estacionamiento
SPIRIT												
S52013660				BRD111010			WBC50274	15.8	5/8"	D/I		
D6587438A	✓	-		S64314410	(1)							
S65714440				BRD111010			WBC50274	15.8	5/8"	D/I		(1) zapatas de freno de estacionamiento
				S64314410	(1)							(1) zapatas de freno de estacionamiento
TOWN & COUNTRY												
S53821680							WBC50263	(1) 19.1	3/4"	D/I		(1) sin ABS
S53821680				BRD111910	(3)		WBC50283	(2) 17.4	11/16"	D/I		(2) con ABS
S53821680				BRD111910			WBC50137	19.1	3/4"	D/I		(3) altura total de 108 mm
				BRR110910		Sol						
				S76121870	(3)							(1) sin control de tracción
S71414850				BRD112710			WBC50142	20.6	13/16"	D/I		(2) con control de tracción
							WBC50137	19.1	3/4"	D/I		(3) zapatas de freno de estacionamiento
D85877340	✓	✓		BRR110910		Sol						(1) con control de tracción
				S81222020	(3)							(2) sin control de tracción
S71414850							WBC50142	20.6	13/16"	D/I		(3) zapatas de freno de estacionamiento
D85877340	✓	✓		BRR110910		Sol						(1) sin control de tracción
				S81222020	(3)							(2) con control de tracción
												(3) zapatas de freno de estacionamiento
D85877340	✓	✓		BRR110910		Sol						(1) sin control de tracción
				S81222020	(1)							(2) con control de tracción
												(3) zapatas de freno de estacionamiento
D13268438	✓	✓		BRR112910		Sol						
D13268438	✓	✓		BRR112910		Sol						
D13268438	(1)	✓	✓	BRR112910	(1)	Sol						(1) caliper de 1 pistón
D15968811	(2)	✓	✓	BRR113410	(2)	Sol						(2) con caliper de 2 pistones
VALIANT												
							WBC50130	20.6	13/16"	D/I		
							WBC50221	23.8	15/16"	D/I		



		 2012... 2013... 2014...	EJE DELANTERO							
			 PASTILLA			 ROTOR	TIPO	 CILINDRO MAESTRO	MEDIDA mm - in	
CHRYSLER										
VOLARE										
		83-85	D2207134A	✓	—			BMC10465	21.0 53/64"	
		86-89	D2207134A	✓	—	BFR110910	Vent	BMC10465	21.0 53/64"	
VOYAGER / GRAND VOYAGER										
		91-95	D5217403A	✓	—	BFR110910	Vent	BMC10467	24.0	
			D5227404A	✓	—	BFR112610	Vent			
		1996	D5917470A	✓	—	BFR112610	Vent	BMC10162	23.8 15/16"	
	4 discos	97-00	D5917470A	✓	—	BFR113410	Vent	BMC10162 (1)	23.8 15/16"	
	2 discos							BMC10183 (2)	23.8 15/16"	
	4 discos	01-02	D85777330	✓	✓	BFR114410	Vent	BMC10243 (1)	27.0 1 1/16"	
								BMC10242 (2)	27.0 1 1/16"	
	2 discos		D85677320	✓	✓	BFR110110	Vent	BMC10162	23.8 15/16"	
	4 discos	03-04	D85777330	✓	✓	BFR114410	Vent	BMC10241 (1)	23.8 15/16"	
								BMC10279 (2)	25.4 1"	
	2 discos		D85677320	✓	✓	BFR110110	Vent	BMC10162	23.8 15/16"	
	4 discos	2005	D85777330	✓	✓	BFR114410	Vent	BMC10241 (1)	23.8 15/16"	
								BMC10279 (2)	25.4 1"	
	2 discos		D85677320	✓	✓	BFR110110	Vent	BMC10162 (3)	23.8 15/16"	
								BMC10319 (4)	23.8 15/16"	
	4 discos	06-08	D85777330	✓	✓	BFR114410	Vent	BMC10279 (1)	25.4 1"	
								BMC10162 (2)	23.8 15/16"	
	2 discos		D85677320	✓	✓	BFR110110	Vent	BMC10319 (3)	23.8 15/16"	
200										
	L4	12-14	D86677410	✓	✓	BFR111410	Vent	BMC10386	22.2 7/8"	
		15-16	D16408867	✓	—	BFR115410	Vent			
	V6	2012	D86677410	✓	✓	BFR111410	Vent	BMC10386	22.2 7/8"	
		2013	D86677410	✓	✓			BMC10386	22.2 7/8"	
		15-16	D16408867	✓	—	BFR116510	Vent			
Convertible		2013	D86677410	✓	✓			BMC10386	22.2 7/8"	
300 / 300C										
	V6	06-07	D10567962	✓	✓	BFR113510	Vent	BMC10329 (1)	25.4 1"	
								BMC10321 (2)	25.4 1"	
		2008	D10567962	✓	✓	BFR113510	Vent			
		09-10	D10567962	✓	✓	BFR113510	Vent	BMC10380	25.4 1"	
		12->	D11498259	✓	—	BFR113510	Vent			







PASTILLA / ZAPATA		ROTOR / TAMBOR		TIPO	CILINDRO DE RUEDA	MEDIDA mm - in		I / D	i
CHRYSLER									
VOLARE									
					WBC50239	15.8	5/8"	D/I	
					WBC50241	14.2	9/16"	D/I	
S52013660			BRD111010		WBC50239	15.8	5/8"	D/I	
					WBC50241	14.2	9/16"	D/I	
VOYAGER / GRAND VOYAGER									
S53821680			BRD111910 ⁽³⁾		WBC50263 ⁽¹⁾	19.1	3/4"	D/I	⁽¹⁾ sin ABS
					WBC50283 ⁽²⁾	17.4	11/16"	D/I	⁽²⁾ con ABS ⁽³⁾ altura total de 108 mm
S53821680			BRD111910		WBC50137	19.1	3/4"	D/I	
			BRR110910 Sol						
			S76121870 ⁽³⁾						⁽¹⁾ sin control de tracción
S71414850			BRD112710		WBC50142	20.6	13/16"	D/I	⁽²⁾ con control de tracción
					WBC50137	19.1	3/4"	D/I	⁽³⁾ zapatas de freno de estacionamiento
D85877340	✓	✓	BRR110910 Sol						⁽¹⁾ con control de tracción
			S81222020 ⁽³⁾						⁽²⁾ sin control de tracción
S71414850					WBC50142	20.6	13/16"	D/I	⁽³⁾ zapatas de freno de estacionamiento
D85877340	✓	✓	BRR110910 Sol						⁽¹⁾ sin control de tracción
			S81222020 ⁽³⁾						⁽²⁾ con control de tracción
S71414850					WBC50142	20.6	13/16"	D/I	⁽³⁾ zapatas de freno de estacionamiento
D85877340	✓	✓	BRR110910 Sol						⁽¹⁾ sin control de tracción
			S81222020 ⁽³⁾						⁽²⁾ con control de tracción
S71414850					WBC50142	20.6	13/16"	D/I	⁽³⁾ zapatas de freno de estacionamiento
D85877340	✓	✓	BRR110910 Sol						⁽¹⁾ con control de tracción
			S81222020 ⁽⁴⁾						⁽²⁾ sin control de tracción
S71414850					WBC50142	20.6	13/16"	D/I	⁽³⁾ con ABS
									⁽⁴⁾ zapatas de freno de estacionamiento
D85877340	✓	✓	BRR110910 Sol						⁽¹⁾ con control de tracción
			S81222020 ⁽⁴⁾						⁽²⁾ sin control de tracción
S71414850					WBC50142	20.6	13/16"	D/I	⁽³⁾ con ABS
									⁽⁴⁾ zapatas de freno de estacionamiento
200									
D10377940	✓	✓	BRR112210 Sol						
CMD17348958	—	✓	BRR113810 Sol						
D10377940	✓	✓	BRR112210 Sol						
D86877430	✓	✓	BRR112410 Sol						
CMD17348958	—	✓	BRR113810 Sol						
D86877430	✓	✓	BRR112410 Sol						
300 / 300C									
D10577963	✓	✓	BRR111510 Sol						⁽¹⁾ con asistente de freno de emergencia y puertos de 14.0 mm
									⁽²⁾ con asistente de freno de emergencia y puertos de 12.0 mm
D10577963	✓	✓	BRR111510 Sol						
D10577963	✓	✓	BRR111510 Sol						
D10537958	✓	—	BRR111510 Sol						



		2012... 2013... 2014...	EJE DELANTERO						MEDIDA mm - in		
			PASTILLA	SM	CM	ROTOR	TIPO	CILINDRO MAESTRO			
CHRYSLER											
300 / 300C cont.											
	V8	2005	D10587965	✓	✓	BFR113210	Vent	BMC10321 ⁽¹⁾	25.4	1"	
		06-07	D10587965	✓	✓	BFR113210	Vent	BMC10329 ⁽¹⁾	25.4	1"	
								BMC10321 ⁽²⁾			
		2008	D10587965	✓	✓	BFR113210	Vent				
		09-10	D10587965	✓	✓	BFR113210	Vent	BMC10380	25.4	1"	
12->	D11498259	✓	-	BFR113210	Vent						
SRT-8		2006	D11498259	✓	-	BFR113610	Vent	BMC10321	25.4	1"	
		07-14	D11498259	✓	-	BFR113610	Vent				
300M											
		99-01	D5917470A	✓	-			BMC10198	23.8	15/16"	
		02-04	D86977440	✓	✓			BMC10198	23.8	15/16"	
DODGE											
ATOS											
		00-03	D11488258 ⁽¹⁾	✓	-	BFR113710	Sol	BMC10114	20.6	13/16"	
		03-04	D11428253 ⁽¹⁾	✓	-	BFR115010	Vent	BMC10114	20.6	13/16"	
		05-12	D11428253 ⁽¹⁾	✓	-	BFR115010	Vent	BMC10114	20.6	13/16"	
ATTITUDE											
GL	2 discos	06-11	D11568266	✓	✓	BFR111010	Vent	BMC10343	22.2	7/8"	
		12-14	D15938806	✓	✓	BFR114610	Vent	BMC10563	20.6	13/16"	
		15-20	CMD17318956	-	✓	BFR115810	Vent	BMC10579	19.1	3/4"	
GLS / GLS Sport	4 discos	06-11	D11568266	✓	✓	BFR111010	Vent	BMC10344	22.2	7/8"	
		12-14	D15938806	✓	✓	BFR114610	Vent	BMC10553	20.6	13/16"	
AVENGER											
		08-12	D86677410	✓	✓	BFR111410	Vent	BMC10384	22.2	7/8"	
		10-12	D86677410	✓	✓	BFR111410	Vent	BMC10386	22.2	7/8"	
		13-14	D86677410	✓	✓	BFR111410	Vent	BMC10386	22.2	7/8"	
R/T		08-09	D86677410	✓	✓	BFR111410	Vent	BMC10386	22.2	7/8"	
CALIBER											
SE	2 discos	07-09	D86677410	✓	✓	BFR111910	Vent	BMC10360	20.6	13/16"	
SE / SXT	4 discos										
SXT											
SE / SXT	2.4L	10-11	D86677410	✓	✓	BFR111410	Vent	BMC10357	20.6	13/16"	
		2012	D86677410	✓	✓	BFR111910	Vent	BMC10357	20.6	13/16"	
R/T		2007	D86677410	✓	✓	BFR111410	Vent	BMC10357	20.6	13/16"	
SRT-4		08-09	D10588236	✓	-						

				EJE TRASERO					
PASTILLA / ZAPATA			ROTOR / TAMBOR	TIPO	CILINDRO DE RUEDA		MEDIDA mm - in	I / D	
CHRYSLER									
300 / 300C cont.									
D10577963	✓	✓	BRR111110	Vent					⁽¹⁾ con ESP
D10577963	✓	✓	BRR111110	Vent					⁽¹⁾ con asistente de freno de emergencia y puertos de 14.0 mm ⁽²⁾ con asistente de freno de emergencia y puertos de 12.0 mm
D10577963	✓	✓	BRR111110	Vent					
D10577963	✓	✓	BRR111110	Vent					
D10537958	✓	—	BRR111110	Vent					
D10537958	✓	—							
D10537958	✓	—							
300M									
D6587438A	✓	—							⁽¹⁾ zapatas de freno de estacionamiento
			S64314410 ⁽¹⁾						
D6587438A	✓	—							⁽¹⁾ zapatas de freno de estacionamiento
			S64314410 ⁽¹⁾						
DODGE									
ATOS									
S70713790					WBC50105	17.8	45/64"	D/I	⁽¹⁾ pastilla chica
S70713790					WBC50105	17.8	45/64"	D/I	⁽¹⁾ pastilla alta
S70713790			BRD110310		WBC50105	17.8	45/64"	D/I	⁽¹⁾ pastilla alta
ATTITUDE									
S91016160			BRD111110		WBC50195	17.4	11/16"	D/I	
S10211616			BRD111310		WBC50345	17.8	45/64"	D/I	
S92416240			BRD111520 ⁽¹⁾						⁽¹⁾ con balero doble instalado
D11578267	✓	—							
D15448428	✓	✓	BRR113510	Sol					
AVENGER									
S91914620			BRD113910		WBC50197	20.6	13/16"	D/I	
D10377940	✓	✓	BRR112210	Sol					
D86877430	✓	✓							
D10377940	✓	✓	BRR112210	Sol					
D86877430	✓	✓	BRR112410	Sol					
CALIBER									
S91914620			BRD113910		WBC50197	20.6	13/16"	D/I	
D10377940	✓	✓	BRR112210	Sol					
D86877430	✓	✓							
D10377940	✓	✓	BRR112410	Sol					
D10377940	✓	✓	BRR112210	Sol					
D10377940	✓	✓	BRR112210	Sol					
D86877430	✓	✓	BRR112410	Sol					



		 2012... 2013... 2014...		EJE DELANTERO						
				 PASTILLA			 ROTOR	TIPO	 CILINDRO MAESTRO	MEDIDA mm - in
DODGE										
CHALLENGER										
	V6 3.6L	13->	D10588236	✓	—	BFR113210	Vent	BMC10380	25.4	1"
SE		2009	D10567962	✓	✓	BFR113510	Vent	BMC10380	25.4	1"
R/T	V8 5.7L	09-13	D10588236	✓	—	BFR113210	Vent	BMC10380	25.4	1"
Scat Pack	V8 6.4L	15-19	D11498259	✓	—	BFR113610	Vent			
SRT-8		08-14	D11498259	✓	—	BFR113610	Vent			
SRT / Widebody	6.2L S/C	15->								
CHARGER										
Daytona R/T		2006	D10587965	✓	✓	BFR113210	Vent	BMC10321	25.4	1"
R/T	5.7L	2006	D10587965	✓	✓	BFR113210	Vent	BMC10321	25.4	1"
		07-19	D10587965	✓	✓	BFR113210	Vent			
SE		06-07	D10567962	✓	✓	BFR113510	Vent	BMC10321 ⁽¹⁾	25.4	1"
		14-15						BMC10329 ⁽²⁾	25.4	1"
SXT		06-07	D10567962	✓	✓	BFR113210	Vent	BMC10329 ⁽¹⁾	25.4	1"
								BMC10321 ⁽²⁾	25.4	1"
		2008	D10567962	✓	✓	BFR113210	Vent			
		09-11	D10567962	✓	✓	BFR113210	Vent	BMC10380	25.4	1"
		2012	D10567962	✓	✓	BFR113510	Vent	BMC10380	25.4	1"
		2013	D10567962	✓	✓	BFR113510	Vent			
SRT	6.2L	15-16								
		17-19								
SRT Widebody		20->								
SRT-8		07-14	D11498259	✓	—	BFR113610	Vent			
Patrulla		06-09	D10587965	✓	✓	BFR113210	Vent	BMC10321	25.4	1"
		10-12	D10567962	✓	✓	BFR113210	Vent			
		13-19	D17678998	✓	—	BFR113210	Vent		25.4	1"
D-100										
		73-78	D08670190	✓	—					
			D2697179A	✓	—					
		79-80	D08670190	✓	—			BMC10453	28.5	1 1/8"
			D2697179A	✓	—					
		81-93	D08670190	✓	—			BMC10453	28.5	1 1/8"
			D2697179A	✓	—					
D-150										
		80-85	D2697179A	✓	—			BMC10453	28.5	1 1/8"
		86-93	D2697179A	✓	—	BFR112310	Vent	BMC10453	28.5	1 1/8"







PASTILLA / ZAPATA		EJE TRASERO		ROTOR / TAMBOR		TIPO	CILINDRO DE RUEDA	MEDIDA mm - in	I / D	i
SM	CM									
DODGE										
CHALLENGER										
D10577963	✓	✓	BRR111110	Vent						
D10577963	✓	✓	BRR111510	Sol						
D10577963	✓	✓	BRR111510	Sol						
D10537958	✓	—								
D10537958	✓	—								
D10537958	✓	—								
CHARGER										
D10577963	✓	✓	BRR111110	Vent						
D10577963	✓	✓	BRR111110	Vent						
D10577963	✓	✓	BRR111110	Vent						
D10577963	✓	✓	BRR111510	Sol						(1) con puertos de 12 mm (2) con puertos de 14 mm
D10577963	✓	✓	BRR111510	Sol						(1) con puertos de 14 mm (2) con puertos de 12 mm
			BRR111110	Vent						
D10577963	✓	✓	BRR111510	Sol						
			BRR111110	Vent						
D10577963	✓	✓	BRR111510	Sol						
			BRR111110	Vent						
D10577963	✓	✓	BRR111510	Sol						
D10577963	✓	✓	BRR111510	Sol						
D10577963	✓	✓	BRR111110	Vent						
D10537958	✓	—								
D10577963	✓	✓								
D10537958	✓	—								
D10577963	✓	✓								
D10577963	✓	✓								
D17668997	✓	—								
D-100										
					WBC50221	23.8	15/16"	D/I		
					WBC50221	23.8	15/16"	D/I		
D-150										
					WBC50221	23.8	15/16"	D/I		
			BRD111810		WBC50221	23.8	15/16"	D/I		



		 2012... 2013... 2014...	EJE DELANTERO					PASTILLA ROTOR CILINDRO MAESTRO MEDIDA mm - in	
					TIPO				
DODGE									
D-250									
		73-78	D08670190	✓	—				
		79-80	D08670190	✓	—				
		81-84	D08670190 D2697179A	✓ ✓	— —				
		85-87	D2697179A	✓	—		BMC10453 ⁽¹⁾ 28.5 1 1/8" BMC10485 ⁽²⁾ 28.5 1 1/8"		
		88-89	D2697179A	✓	—		BMC10453 28.5 1 1/8" BMC10485 28.5 1 1/8"		
		90-93	D2697179A	✓	—		BMC10485 28.5 1 1/8"		
DAKOTA									
	V6 3.7L	1996				BFR112510 Vent			
		05-06	D10847991	✓	✓	BFR116410 Vent	BMC10305 ⁽¹⁾ 28.5 1 1/8" BMC10306 ⁽²⁾ 28.5 1 1/8"		
		07-12	D10847991	✓	✓	BFR116410 Vent	BMC10305 ⁽¹⁾ 28.5 1 1/8" BMC10306 ⁽²⁾ 28.5 1 1/8"		
DART									
		70-76							
		77-81							
		83-85	D2207134A	✓	—		BMC10465 21.0 53/64"		
		86-89	D2207134A	✓	—	BFR110910 Vent	BMC10465 21.0 53/64"		
		13-16	D16408867	✓	—	BFR115410 Vent			
DURANGO									
		1998				BFR113310 Vent			
		99-02				BFR113310 Vent	BMC10203 28.5 1 1/8"		
		2003	D96678680	✓	—		BMC10203 28.5 1 1/8"		
		2004	D96678680	✓	—	BFR115310 Vent	BMC10287 ⁽¹⁾ 31.7 1 1/4" BMC10286 ⁽²⁾ 31.7 1 1/4"		
		2005	D89777740	✓	—	BFR115310 Vent	BMC10287 ⁽¹⁾ 31.7 1 1/4" BMC10286 ⁽²⁾ 31.7 1 1/4"		
		2006	D89777740	✓	—	BFR115310 Vent	BMC10374 ⁽¹⁾ 30.1 1 3/16" BMC10376 ⁽²⁾ 31.7 1 1/4"		
		07-09	D10847991	✓	✓	BFR115310 Vent	BMC10376 31.7 1 1/4"		
	V6	12-15	D14558655	✓	✓	BFR116610 Vent	BMC10546 27.0 1 1/16"		
	V8					BFR117010 Vent			

		EJE TRASERO							
PASTILLA / ZAPATA			TIPO		MEDIDA mm - in		I / D		
DODGE									
D-250									
S35821400									
S35821400				WBC50124	22.2	7/8"	Izq	⁽¹⁾ para eje trasero de 5000 lb	
				WBC50125	22.2	7/8"	Der	⁽²⁾ para eje trasero de 4500 lb	
S35821400				WBC50289	25.4	1"	Izq		
				WBC50290	25.4	1"	Der		
				WBC50124	22.2	7/8"	Izq		
				WBC50125	22.2	7/8"	Der		
S35821400				WBC50124	22.2	7/8"	Izq		
				WBC50125	22.2	7/8"	Der		
DAKOTA									
S53821680				WBC50263	19.1	3/4"	D/I	⁽¹⁾ con tambor de 9"	
S85315820			BRD110810	WBC50185	26.9	1 1/16"	D/I	⁽¹⁾ con ABS en ruedas traseras ⁽²⁾ con ABS en las 4 ruedas	
S92215820			BRD110810	WBC50185	26.9	1 1/16"	D/I	⁽¹⁾ con ABS en ruedas traseras ⁽²⁾ con ABS en las 4 ruedas	
DART									
				WBC50130	20.6	13/16"	D/I		
				WBC50221	23.8	15/16"	D/I		
				WBC50239	15.8	5/8"	D/I		
				WBC50241	14.2	9/16"	D/I		
S52013660			BRD111010	WBC50239	15.8	5/8"	D/I		
				WBC50241	14.2	9/16"	D/I		
CMD16478875	—	✓							
DURANGO									
S72321820				WBC50124	22.2	7/8"	Izq		
				WBC50125	22.2	7/8"	Der		
S72321820				WBC50289	25.4	1"	Izq		
				WBC50290	25.4	1"	Der		
D89877750	✓	—							
D96778690	✓	✓	BRR110410	Vent				⁽¹⁾ con control de tracción ⁽²⁾ sin control de tracción	
D96778690	✓	✓	BRR110410	Vent				⁽¹⁾ con control de tracción ⁽²⁾ sin control de tracción	
D96778690	✓	✓	BRR110410	Vent				⁽¹⁾ sin control de estabilidad ⁽²⁾ con control de estabilidad	
D96778690	✓	✓	BRR110410	Vent					
D14988698	✓	✓	BRR112810	Sol					
			BRR113210	Vent					









		 2012... 2013... 2014...	EJE DELANTERO						 PASTILLA		 ROTOR		 CILINDRO MAESTRO		MEDIDA mm - in		
					TIPO												
DODGE																	
DURANGO cont.																	
Touring		2020	D14558655	✓	✓	BFR116610	Vent										
GT						BFR117010	Vent										
R/T		00-02				BFR113310	Vent	BMC10203	28.5	1 1/8"							
		2003	D96678680	✓	—			BMC10203	28.5	1 1/8"							
		14-16	D14558655	✓	✓	BFR117010	Vent										
		17-19	CMD16298856		✓	BFR117010	Vent										
		20->															
GRAND CARAVAN																	
		17-20	D15898800	✓	✓	BFR117110	Vent										
H100																	
Chasis Gasolina		03-05	D11378247	✓	—	BFR115110	Vent	BMC10504	23.8	15/16"							
Chasis Diesel		06-10	D15208729	✓	—	BFR116210	Vent	BMC10510	27.0	1 1/16"							
Van / Wagon		10-14	D15668775	✓	—	BFR110610	Vent	BMC10565	27.0	1 1/16"							
i10																	
		12-14	D16018815	✓	✓	BFR115710	Vent	BMC10419	20.6	13/16"							
JOURNEY																	
		09-11	D13278481	✓	✓	BFR114810	Vent	BMC10530	23.8	15/16"							
	L4	12-13	D15898800	✓	✓	BFR114810	Vent	BMC10530 ⁽¹⁾	23.8	15/16"							
	V6					BFR117110	Vent	BMC10568 ⁽²⁾	27.0	1 1/16"							
		14-20	D15898800	✓	✓	BFR117110	Vent	BMC10568	27.0	1 1/16"							
R/T		09-11	D13278481	✓	✓	BFR114810	Vent	BMC10530	23.8	15/16"							
		12-16	D15898800	✓	✓	BFR117110	Vent	BMC10568	27.0	1 1/16"							
MICROBUS																	
		78-79	D2697179A	✓	—												
		80-83	D2697179A	✓	—			BMC10453	28.5	1 1/8"							
		84-87	D2697179A	✓	—			BMC10453 ⁽¹⁾	28.5	1 1/8"							
	BMC10485 ⁽²⁾							28.5	1 1/8"								

		EJE TRASERO							
PASTILLA / ZAPATA			TIPO		MEDIDA mm - in		I / D		
DODGE									
DURANGO cont.									
D14988698	✓	✓	BRR112810	Sol					
S72321820					WBC50289	25.4 1"	Izq		
					WBC50290	25.4 1"	Der		
D89877750	✓	—							
D14988698	✓	✓	BRR113210	Vent					
D14988698	✓	✓	BRR113210	Vent					
D10537958	✓	—							
GRAND CARAVAN									
D15968811	✓	✓	BRR113410	Sol					
H100									
					WBC50116	22.2 7/8"	Izq		
					WBC50115	22.2 7/8"	Der		
S10261399			BRD110410		WBC50302	17.4 11/16"	Izq		
					WBC50299	17.4 11/16"	Der		
S10031673			BRD110110		WBC50335	22.2 7/8"	D/I		
i10									
S10441706			BRD112610		WBC50334	15.8 5/8"	D/I		
JOURNEY									
D13268438	✓	✓	BRR112910	Sol					
D15968811	✓	✓	BRR112910	Sol					
			BRR113410	Sol					
D15968811	✓	✓	BRR113410	Sol					
D13268438	✓	✓	BRR112910	Sol					
D15968811	✓	✓	BRR113410	Sol					
MICROBUS									
					WBC50289	25.4 1"	Izq		
					WBC50290	25.4 1"	Der		
					WBC50219	26.9 1 1/16"	Izq		
					WBC50220	26.9 1 1/16"	Der		
					WBC50124 ⁽³⁾	22.2 7/8"	Izq	⁽¹⁾ para eje delantero de 3600 lb	
					WBC50125 ⁽³⁾	22.2 7/8"	Der	⁽²⁾ para eje delantero de 4500 lb	
					WBC50289 ⁽⁴⁾	25.4 1"	Izq	⁽³⁾ para zapata de 2 1/2"	
					WBC50290 ⁽⁴⁾	25.4 1"	Der	⁽⁴⁾ para zapata de 2 1/2" y 3"	
					WBC50219 ⁽⁵⁾	26.9 1 1/16"	Izq		
					WBC50220 ⁽⁵⁾	26.9 1 1/16"	Der	⁽⁵⁾ para zapata de 3"	
					WBC50133 ⁽⁶⁾	28.5 1 1/8"	Izq		
					WBC50134 ⁽⁶⁾	28.5 1 1/8"	Der	⁽⁶⁾ para zapata de 3"	











		 2012... 2013... 2014...	EJE DELANTERO							 PASTILLA		 ROTOR		 CILINDRO MAESTRO		MEDIDA mm - in	
					TIPO												
DODGE																	
MICROBUS cont.																	
		88-93	D2697179A	✓	—					BMC10485	28.5	1 1/8"					
		94-95	D2697179A	✓	—												
NEON																	
	2 discos	95-99	D6427518A	✓	—	BFR111510	Vent	BMC10148	21.0	53/64"							
		00-01	D6427518A	✓	—	BFR114210	Vent	BMC10225	22.2	7/8"							
		02-04	D6427518A	✓	—	BFR114210	Vent	BMC10225	22.2	7/8"							
	4 discos	95-99	D6427518A	✓	—	BFR111510	Vent	BMC10149	22.2	7/8"							
		00-01	D6427518A	✓	—	BFR114210	Vent	BMC10224	23.8	15/16"							
		02-04	D6427518A	✓	—	BFR114210	Vent	BMC10224 ⁽¹⁾	23.8	15/16"							
								BMC10230 ⁽²⁾	23.8	15/16"							
2005	D73075970	✓	—	BFR114210	Vent	BMC10224	23.8	15/16"									
17-18 2020	CMD20669298	—	✓														
R/T	2 discos	2020	D6427518A	✓	—	BFR114210	Vent	BMC10148	21.0	53/64"							
		00-01	D6427518A	✓	—	BFR114210	Vent	BMC10225	22.2	7/8"							
		02-04	D6427518A	✓	—	BFR114210	Vent	BMC10225	22.2	7/8"							
	4 discos	00-04	D6427518A	✓	—	BFR114210	Vent	BMC10224	23.8	15/16"							
SRT-4		2004	D6427518A	✓	—	BFR114210	Vent	BMC10224	23.8	15/16"							
		04-05	D73075970	✓	—			BMC10224	23.8	15/16"							
NITRO																	
		07-12	D12738389	✓	✓	BFR116710	Vent	BMC10377	27.0	1 1/16"							
RAM CHARGER																	
		88-96	D2697179A	✓	—	BFR112310	Vent	BMC10453	28.5	1 1/8"							
		99-01	D82176940	✓	—												
STRATUS																	
	4 discos	95-00	D6507530A	✓	—	BFR110410	Vent										

PASTILLA / ZAPATA				ROTOR / TAMBOR	TIPO	CILINDRO DE RUEDA	MEDIDA mm - in		I / D		
DODGE											
MICROBUS cont.											
						WBC50124	⁽¹⁾	22.2	7/8"	lzq	⁽¹⁾ para zapata de 2 1/2"
						WBC50125	⁽¹⁾	22.2	7/8"	Der	
						WBC50289	⁽²⁾	25.4	1"	lzq	⁽²⁾ para zapata de 2 1/2"
						WBC50290	⁽²⁾	25.4	1"	Der	
						WBC50133	⁽³⁾	28.5	1 1/8"	lzq	⁽³⁾ para zapata de 3"
						WBC50134	⁽³⁾	28.5	1 1/8"	Der	
NEON											
S68914730				BRD110910		WBC50239		15.8	5/8"	D/I	
S68914730				BRD110910		WBC50148		17.4	11/16"	D/I	
S68914730				BRD110910		WBC50261		17.4	11/16"	D/I	
D6417438B	✓	-									
				S64314410							
D6417438B	✓	-									
				S64314410							
D6417438B	✓	-									⁽¹⁾ con ABS
				S64314410							⁽²⁾ sin ABS
				S64314410							
S68914730				BRD110910		WBC50239		15.8	5/8"	D/I	
S68914730				BRD110910		WBC50148		17.4	11/16"	D/I	
S68914730				BRD110910		WBC50261		17.4	11/16"	D/I	
D6417438B	✓	-									
				S64314410	⁽¹⁾						⁽¹⁾ zapatas de freno de estacionamiento
D6417438B	✓	-									
				S64314410	⁽¹⁾						⁽¹⁾ zapatas de freno de estacionamiento
				S64314410	⁽¹⁾						⁽¹⁾ zapatas de freno de estacionamiento
NITRO											
D12748390	✓	✓		BRR113010	Sol						
RAM CHARGER											
						WBC50221		23.8	15/16"	D/I	
STRATUS											
D6417438B	✓	-		BRR110610	Sol						
				S64314410	⁽²⁾						⁽²⁾ zapatas de freno de estacionamiento



		 2012... 2013... 2014...		EJE DELANTERO						
				 PASTILLA			 ROTOR	TIPO	CILINDRO MAESTRO	MEDIDA mm - in
DODGE										
STRATUS cont.										
R/T	2 discos	95-00	D6507530A	✓	—	BFR111610	Vent	BMC10154 ⁽¹⁾	22.2	7/8"
		01-06	D86977440	✓	✓	BFR110410	Vent	BMC10112	25.4	1"
	01-06	97-00	D6507530A	✓	—	BFR110410	Vent			
		01-06	D86977440	✓	✓	BFR110410	Vent	BMC10112	25.4	1"
VAN 1000										
		08-09	D34972410	✓	—					
VERNA										
		04-06	D40472930	✓	—	BFR115610	Vent	BMC10247	22.2	7/8"
VIPER										
		04-10						BMC10203	28.5	1 1/8"
VISION										
		15-18	CMD19069135	—	✓	BFR390310	Vent			
FIAT										
ALBEA										
		09-10	D15388747	✓	—	BFR390110	Vent			
DUCATO										
Van / Wagon / Chasis		08->	D15408748	✓	—					
GRANDE PUNTO										
		07-09	D00013470	✓	—	BFR390310	Vent			
Punto		2009	D35072420	✓	—					
IDEA ADVENTURE										
		08-09	D15388747	✓	—	BFR390410	Vent			
MOBI										
		17->	CMD00013490	—	✓	BFR390710	Sol			
PALIO										
Sedán / HB		04-08	D15388747	✓	—	BFR390110	Vent	BMC10506	22.2	7/8"
HB		13-17				BFR390310	Vent			
Adventure		04-11	D15388747	✓	—	BFR390110	Vent	BMC10506	22.2	7/8"
		13-20	D15388747	✓	—	BFR390410	Vent	BMC10506 ⁽¹⁾	22.2	7/8"
Sporting	1.6L	16-17	D15388747	✓	—	BFR390110	Vent			
PANDA										
4X4		07-09	D15388747	✓	—	BRR390210	Sol			
		11-12				BRR390210	Sol			







PASTILLA / ZAPATA				ROTOR / TAMBOR	TIPO	CILINDRO DE RUEDA	MEDIDA mm - in		I / D	
DODGE										
STRATUS cont.										
S52013660				BRD111010		WBC50280	19.1	3/4"	D/I	(1) sin ABS
D6417438B	✓	-		BRR110610 Sol						(1) zapatas de freno de estacionamiento
				S64314410 (1)						
D6417438B	✓	-		BRR110610 Sol						(1) zapatas de freno de estacionamiento
				S64314410 (1)						
D6417438B	✓	-		BRR110610 Sol						(1) zapatas de freno de estacionamiento
				S64314410 (1)						
VAN 1000										
S52413700										
VERNA										
S80814950				BRD113510		WBC50105	17.8	45/64"	D/I	
VIPER										
VISION										
S10291695 (1)				BRD112510						(1) con frenos TRW / VARGA
S00015110 (2)										(2) con frenos ATTE
FIAT										
ALBEA										
S00015050										
DUCATO										
D18409068	✓	-								
D15708779	✓	✓								
				S10671722 (1)						(1) zapatas de freno de estacionamiento
GRANDE PUNTO										
S10291695										
IDEA ADVENTURE										
S10271693						WBC50361	20.6	13/16"	D/I	
MOBI										
				BRD390410						
PALIO										
S00015050						WBC50111	19.1	3/4"	D/I	
S10291695				BRD112510						
S10271693				BRD390110		WBC50361 (1)	20.6	13/16"	D/I	(1) dos orificios de fijación
						WBC50356 (2)	20.6	13/16"		(2) un orificio de fijación
S10271693				BRD390110		WBC50361 (2)	20.6	13/16"	D/I	(1) sin ABS
						WBC50356 (3)	20.6	13/16"		(2) dos orificios de fijación (3) un orificio de fijación (hasta 2016)
PANDA										



		2012... 2013... 2014...	EJE DELANTERO							
			PASTILLA	SM	CM	ROTOR	TIPO	CILINDRO MAESTRO	MEDIDA mm - in	
FIAT										
STRADA PICK UP										
Adventure		07-10	D15388747	✓	—	BFR390110	Vent	BMC10506	22.2	7/8"
		13-14				BFR390410	Vent	BMC10506 ⁽¹⁾	22.2	7/8"
Doble Cabina		11-14	D15388747	✓	—	BFR390110	Vent			
Trekking		09-14	D15388747	✓	—	BFR390110	Vent			
UNO										
		13-20	D00013800	✓	—	BFR390610	Vent			
500										
		09-11				BFR390310	Vent			
		12-17	D15688777	✓	✓	BFR390310	Vent			
500 L										
		15-19	CMD17218945	—	✓					
500 X										
		2016	CMD18119046	—	✓	BFR115410	Vent			
500 ABARTH										
		12-13				BFR390410	Vent			
		14-17								
FORD										
AEROSTAR										
		1991	D2497125A	✓	—	BFR122810	Vent	BFR122820 ⁽¹⁾		
		92-93	D2497125A	✓	—					
		94-95	D2497125A	✓	—					
CONTOUR										
L4		95-97				BFR122010	Vent			
		98-00				BFR122010	Vent	BMC10201	25.4	1"
V6		1997				BFR122010	Vent	BMC10201	25.4	1"
		98-00				BFR122010	Vent	BMC10201	25.4	1"
COUGAR										
		84-86						BMC10469 ⁽¹⁾	21.0	53/64"
		1987						BMC10481 ⁽¹⁾	21.0	8.302







PASTILLA / ZAPATA				ROTOR / TAMBOR	TIPO	CILINDRO DE RUEDA	MEDIDA mm - in	I / D	
FIAT									
STRADA PICK UP									
S00015090						WBC50361	⁽¹⁾ 20.6 13/16"	D/I	⁽¹⁾ dos orificios de fijación
						WBC50356	⁽²⁾ 20.6 13/16"	D/I	⁽²⁾ un orificio de fijación
S10271693				BRD390110		WBC50361	⁽²⁾ 20.6 13/16"	D/I	⁽¹⁾ sin ABS
						WBC50356	⁽³⁾ 20.6 13/16"	D/I	⁽²⁾ dos orificios de fijación
S00015090						WBC50359	⁽⁴⁾ 20.6 13/16"	D/I	⁽³⁾ un orificio de fijación
									⁽⁴⁾ cuerpo de aluminio
S10271693				BRD390110		WBC50361	⁽¹⁾ 20.6 13/16"	D/I	⁽¹⁾ dos orificios de fijación
						WBC50356	⁽²⁾ 20.6 13/16"	D/I	⁽²⁾ un orificio de fijación
S10271693				BRD390110		WBC50361	⁽¹⁾ 20.6 13/16"	D/I	⁽¹⁾ dos orificios de fijación
						WBC50356	⁽²⁾ 20.6 13/16"	D/I	⁽²⁾ un orificio de fijación
UNO									
S10291695	⁽¹⁾			BRD390410					⁽¹⁾ con frenos TRW / VARGA
S00015110	⁽²⁾								⁽²⁾ con frenos ATTE, a partir de 2015
500									
				BRR390210	Sol				
D15698778	✓	✓		BRR390210	Sol				
500 L									
500 X									
CMD18099044	-	✓		BRR114310	Sol				
500 ABARTH									
D15698778	✓	✓		BRR390210	Sol				
D15698778	✓	✓							
FORD									
AEROSTAR									
S58120890						WBC50269	22.2 7/8"	D/I	⁽¹⁾ incluye baleros cónicos
S58120890						WBC50269	22.2 7/8"	D/I	
S58120890						WBC50287	23.8 15/16"	D/I	
CONTOUR									
S69614790						WBC50286	22.2 7/8"	D/I	
S73615040						WBC50286	22.2 7/8"	D/I	
S69614790						WBC50130	20.6 13/16"	D/I	
S73615040						WBC50130	20.6 13/16"	D/I	
COUGAR									
									⁽¹⁾ tambor de 9"
									⁽¹⁾ sin ABS



		 2012... 2013... 2014...	EJE DELANTERO						 CILINDRO MAESTRO		MEDIDA mm - in	
			 PASTILLA			 ROTOR		TIPO				
FORD												
COUGAR cont.												
		1988							BMC10481 ⁽¹⁾	21.0	& 30.2	
		89-90							BMC10490 ⁽¹⁾	25.4	1"	
		91-95					BFR122210	Vent	BMC10490 ⁽¹⁾	25.4	1"	
XR7		93-95				BFR122210	Vent	BMC10490 ⁽¹⁾	25.4	1"		
		96-97						BMC10490 ⁽¹⁾	25.4	1"		
COURIER												
		01-12	D11408251	✓	✓	BFR126110	Vent	BMC10110	23.8	15/16"		
E-150 / ECONOLINE 150												
Carga / Pasaje		1995	D63275030	✓	-	BFR123810	Vent	BMC10478 ⁽²⁾	27.0	1 1/16"		
						BFR123820 ⁽¹⁾	Vent	BMC10501 ⁽³⁾	27.0	1 1/16"		
		1996	D63275030	✓	-	BFR123810	Vent	BMC10478 ⁽²⁾	27.0	1 1/16"		
						BFR123820 ⁽¹⁾	Vent	BMC10146 ⁽³⁾	27.0	1 1/16"		
		97-00	D63275030	✓	-	BFR123910	Vent	BMC10186 ⁽²⁾	28.5	1 1/8"		
						BFR123920 ⁽¹⁾	Vent					
		01-03	D63275030	✓	-	BFR123910	Vent	BMC10186 ⁽²⁾	28.5	1 1/8"		
						BFR123920 ⁽¹⁾	Vent					
	04-05	D10457948	✓	-	BFR220110	Vent	BMC10285 ⁽¹⁾	31.7	1 1/4"			
	06-07	D10457948	✓	-	BFR220110	Vent	BMC10499	31.7	1 1/4"			
	2008	D13288440	✓	-	BFR220910	Vent						
	09-14	D13288440	✓	-	BFR220910	Vent	BMC10408 ⁽¹⁾	33.3	1 5/16"			
E-250												
Carga / Pasaje		95-96	D65575350	✓	-	BFR124110	Vent	BMC10479 ⁽¹⁾	28.5	1 1/8"		
						BFR124210 ⁽³⁾	Vent	BMC10145 ⁽²⁾	28.5	1 1/8"		
		97-99	D65575350	✓	-	BFR124110	Vent	BMC10187 ⁽¹⁾	31.7	1 1/4"		
						BFR124210 ⁽²⁾	Vent					
Carga		98-99	D65575350	✓	-	BFR124110	Vent	BMC10187	31.7	1 1/4"		
						BFR124210 ⁽¹⁾	Vent					
E-350 / ECONOLINE 350												
Carga		92-93						BMC10479	28.5	1 1/8"		
		1994						BMC10479 ⁽¹⁾	28.5	1 1/8"		
								BMC10145 ⁽²⁾	28.5	1 1/8"		

PASTILLA / ZAPATA		EJE TRASERO		ROTOR / TAMBOR		TIPO	CILINDRO DE RUEDA	MEDIDA mm - in	I / D	i
SM	CM									
FORD										
COUGAR cont.										
							WBC50235	19.1 3/4"	D/I	(1) sin ABS
							WBC50235	19.1 3/4"	D/I	(1) sin ABS
							WBC50235	19.1 3/4"	D/I	(1) con 4 puertos, sin ABS
										(1) cilindro con 4 puertos
										(1) cilindro con 4 puertos
COURIER										
S73615040			BRD123510				WBC50110	22.2 7/8"	D/I	
E-150 / ECONOLINE 150										
			BRD123910				WBC50126	23.8 15/16"	Izq	(1) incluye baleros cónicos
							WBC50127	23.8 15/16"	Der	(2) sin control de velocidad
										(3) con control de velocidad
			BRD123910				WBC50126	23.8 15/16"	Izq	(1) incluye baleros cónicos
							WBC50127	23.8 15/16"	Der	(2) sin control de velocidad
										(3) con control de velocidad
S72321820			BRD123910				WBC50289	25.4 1"	Izq	(1) incluye baleros cónicos
							WBC50290	25.4 1"	Der	(2) sin control de velocidad
S72321820							WBC50289	25.4 1"	Izq	(1) incluye baleros cónicos
							WBC50290	25.4 1"	Der	(2) sin control de velocidad
D10467949	✓	-	BRR124310	Vent						(1) con control de velocidad
D10467949	✓	-	BRR124310	Vent						
D13298441	✓	-	BRR124810	Vent						
D13298441	✓	-	BRR124810	Vent						(1) 2 puertos, con control de estabilidad
E-250										
							WBC50140	28.5 1 1/8"	Izq	(1) sin control de velocidad
							WBC50141	28.5 1 1/8"	Der	(2) con control de estabilidad
										(3) ABS en las 4 ruedas
							WBC50140	28.5 1 1/8"	Izq	(1) con control de estabilidad
							WBC50141	28.5 1 1/8"	Der	(2) ABS en las 4 ruedas
D80276730	✓	-	BRR121710	Vent						(1) ABS en las 4 ruedas
			S77121920	(2)						(2) zapatas de freno de estacionamiento
E-350 / ECONOLINE 350										
							WBC50224	(1) 26.9 1 1/16"	Izq	(1) rodada sencilla
							WBC50225	(1) 26.9 1 1/16"	Der	(2) con doble rodada y zapata de 3"
							WBC50223	(2) 30.1 1 3/16"	Izq	(3) con doble rodada y zapata de 3 1/2"
							WBC50222	(2) 30.1 1 3/16"	Der	
							WBC50133	(3) 28.5 1 1/8"	Izq	
							WBC50134	(3) 28.5 1 1/8"	Der	
							WBC50224	(3) 26.9 1 1/16"	Izq	(1) sin control de velocidad
							WBC50225	(3) 26.9 1 1/16"	Der	(2) con control de velocidad
							WBC50223	(4) 30.1 1 3/16"	Izq	(3) con rodada sencilla
							WBC50222	(4) 30.1 1 3/16"	Der	(4) con doble rodada
							WBC50133	(5) 28.5 1 1/8"	Izq	(5) con rodada sencilla
							WBC50134	(5) 28.5 1 1/8"	Der	



 		EJE DELANTERO									
		 PASTILLA  	 ROTOR	TIPO	 CILINDRO MAESTRO	MEDIDA mm - in					
FORD											
E-350 / ECONOLINE 350 cont.											
	95-96	D65575350	✓	—	BFR124110 Vent BFR124210 ⁽⁵⁾ Vent	BMC10479 ⁽¹⁾ BMC10145 ⁽²⁾	28.5 28.5	1 1/8" 1 1/8"			
	97-98	D65575350	✓	—	BFR124110 Vent BFR124210 ⁽⁴⁾ Vent	BMC10187 ⁽¹⁾	31.7	1 1/4"			
	99-00	D65575350	✓	—	BFR124110 Vent BFR124210 ⁽¹⁾ Vent	BMC10210 ⁽²⁾	33.3	1 5/16"			
Pasajeros	99-06	D65575350	✓	—	BFR124110 Vent BFR124210 ⁽¹⁾ Vent	BMC10210 ⁽²⁾	33.3	1 5/16"			
	2007	D65575350	✓	—	BFR124110 Vent BFR124210 ⁽¹⁾ Vent						
	2008	D13288440	✓	—	BFR220910 Vent						
	09-14	D13288440	✓	—	BFR220910 Vent	BMC10408 ⁽¹⁾	33.3	1 5/16"			
TDI	2007	D65575350	✓	—	BFR124110 Vent						
ECOSPORT											
	03-05	D11758289	✓	✓	BFR126310 Vent	BMC10493	22.2	7/8"			
	06-12	D11758289	✓	✓	BFR126310 Vent	BMC10493 ⁽¹⁾	22.2	7/8"			
						BMC10353 ⁽²⁾	23.8	15/16"			
	T/A	2008	D10447947	✓	✓	BFR125710 Vent	BMC10353 ⁽¹⁾	23.8	15/16"		
	13-18	D10447947	✓	✓	BFR129510 Vent	BMC10566	22.2	7/8"			
EDGE											
	07-08	D12588377	✓	✓		BMC10393	22.2	7/8"			
	09-10	D12588377	✓	✓	BFR123110 Vent	BMC10393	22.2	7/8"			
	11-12	D12588377	✓	✓	BFR123110 Vent	BMC10393	22.2	7/8"			
	13-15	D12588377	✓	✓	BFR123110 Vent	BMC10393	22.2	7/8"			
	16-18	CMD18189053	—	✓							
ESCAPE											
	01-04	D84377190	✓	✓	BFR127410 Vent	BMC10237 ⁽¹⁾	25.4	1"			

PASTILLA / ZAPATA		EJE TRASERO		ROTOR / TAMBOR		TIPO	CILINDRO DE RUEDA	MEDIDA mm - in	I / D	i
SM	CM									
FORD										
E-350 / ECONOLINE 350 cont.										
							WBC50140	⁽³⁾ 28.5 1 1/8"	Izq	⁽¹⁾ sin control de velocidad ⁽²⁾ con control de velocidad
							WBC50141	⁽³⁾ 28.5 1 1/8"	Der	⁽³⁾ con rodada sencilla
							WBC50223	⁽⁴⁾ 30.1 1 3/16"	Izq	⁽⁴⁾ con doble rodada
							WBC50222	⁽⁴⁾ 30.1 1 3/16"	Der	⁽⁵⁾ ABS en las 4 ruedas
							WBC50140	⁽²⁾ 28.5 1 1/8"	Izq	⁽¹⁾ rodada sencilla, con control de velocidad
							WBC50141	⁽²⁾ 28.5 1 1/8"	Der	⁽²⁾ rodada sencilla
							WBC50223	⁽³⁾ 30.1 1 3/16"	Izq	⁽³⁾ doble rodada
							WBC50222	⁽³⁾ 30.1 1 3/16"	Der	⁽⁴⁾ ABS en las 4 ruedas
										⁽¹⁾ ABS en las 4 ruedas ⁽²⁾ sin control de estabilidad
D80276730	✓	—	BRR121710			Vent				⁽¹⁾ ABS en las 4 ruedas ⁽²⁾ sin control de estabilidad
			S77121920	⁽³⁾						⁽³⁾ zapatas de freno de estacionamiento
D80276730	✓	—	BRR121710			Vent				⁽¹⁾ ABS en las 4 ruedas ⁽²⁾ rodada sencilla, con ABS en las cuatro ruedas y sin control de velocidad
			S77121920	⁽³⁾						⁽³⁾ zapatas de freno de estacionamiento
D13298441	✓	—	BRR124810			Vent				
D13298441	✓	—	BRR124810			Vent				⁽¹⁾ 2 puertos, con control de estabilidad
D80276730	✓	—	BRR121710			Vent				
ECOSPORT										
S99316640			BRD123210				WBC50291	20.6 13/16"	D/I	
			BRD123220	⁽¹⁾						⁽¹⁾ con balero doble integrado
S99316640			BRD123210				WBC50291	20.6 13/16"	D/I	⁽¹⁾ T/M ⁽²⁾ T/A
			BRD123220	⁽³⁾						⁽³⁾ con balero doble integrado
S99316640			BRD123210				WBC50291	20.6 13/16"	D/I	⁽¹⁾ T/A
			BRD123220	⁽²⁾						⁽²⁾ con balero doble integrado
S10541713			BRD123310				WBC50332	20.6 13/16"	D/I	
EDGE										
D12598378	✓	✓	BRR123410			Vent				
D12598378	✓	✓	BRR123410			Vent				
D13778488	✓	✓	BRR123210			Sol				
CMD17548970	—	✓	BRR123210			Sol				
CMD18338893	—	✓								
ESCAPE										
S76015240			BRD124210				WBC50155	23.8 15/16"	D/I	⁽¹⁾ T/A



		2012... 2013... 2014...	EJE DELANTERO								
			PASTILLA	SM	CM	ROTOR	TIPO	CILINDRO MAESTRO	MEDIDA mm - in		
FORD											
ESCAPE cont.											
	05-07	D10477950	✓	✓	BFR127410	Vent	BMC10301	⁽¹⁾	27.0	1 1/16"	
			D84377190	✓	✓	BFR127410	Vent	BMC10302	⁽¹⁾	25.4	1"
								BMC10304	⁽²⁾	25.4	1"
	2008	D10477950	BFR120210	✓	✓	Vent	BMC10414	⁽¹⁾	27.0	1 1/16"	
							BMC10415	⁽²⁾	27.0	1 1/16"	
	09-12	D10477950	BFR120210	✓	✓	Vent	BMC10414	⁽¹⁾	27.0	1 1/16"	
							BMC10415	⁽²⁾	27.0	1 1/16"	
	2.5L	13-16	D10447947	✓	✓	BFR410410	Vent	BMC10545		25.4	1"
		17-19	D10447947	✓	✓	BFR410410	Vent	BMC10545		25.4	1"
	2.0T	14-16	D16458873	✓	✓	BFR410710	Vent	BMC10545		25.4	1"
17-19		D16458873	✓	✓	BFR410710	Vent	BMC10545		25.4	1"	
20->											
4X4	2006	D10477950	✓	✓	BFR120210	Vent	BMC10301		27.0	1 1/16"	
	2007	D84377190	✓	✓	BFR120210	Vent	BMC10301		27.0	1 1/16"	
ESCORT											
	94-96	D47373530	✓	-	BFR126010	Vent					
		D46672190	✓	-							
		D47373530	✓	-	BFR126010	Vent					
	97-99	D47373530	✓	-	BFR126010	Vent	BMC10205	⁽¹⁾	23.8	15/16"	
						BMC10206	⁽²⁾	23.8	15/16"		
ZX2	98-01	D47373530	✓	-	BFR126010	Vent	BMC10200	⁽¹⁾	23.8	15/16"	
						BMC10199	⁽²⁾	23.8	15/16"		
EXCURSION											
	01-05	D82476250	✓	✓			BMC10211		34.9	1 3/8"	
EXPEDITION											
	4X2	97-99	D70275760	✓	✓	BFR125110	Vent	BMC10174	⁽¹⁾	31.7	1 1/4"
								BMC10104	⁽²⁾	31.7	1 1/4"
	2000	D70275760	✓	✓	BFR221410	Vent	BMC10174		31.7	1 1/4"	
	2001	D70275760	BFR221410	✓	✓	Vent	BMC10174	⁽¹⁾	31.7	1 1/4"	
							BMC10173	⁽²⁾	31.7	1 1/4"	
	02-06	D93478370	BFR128210	✓	-	Vent	BMC10260	⁽¹⁾	28.5	1 1/8"	
							BMC10261	⁽²⁾	28.5	1 1/8"	
	07-09	D12788394	✓	✓	BFR124310	Vent					
	2010	D14148528	✓	✓	BFR124310	Vent	BMC10446		30.1	1 3/16"	
	11-14	D14148528	✓	✓	BFR124310	Vent	BMC10544		30.1	1 3/16"	
15-16	D17708528	✓	-	BFR124310	Vent						
2017	D14148528	✓	✓	BFR124310	Vent						
18->	D14148528	✓	✓	BFR124310	Vent						

		EJE TRASERO							
PASTILLA / ZAPATA			TIPO		MEDIDA mm - in		I / D		
FORD									
ESCAPE cont.									
D10557961	✓	—							
S76015240			BRD124210		WBC50155	23.8 15/16"	D/I	(1) T/A (2) T/M	
D10557961	✓	—						(1) T/A	
S93616290			BRD120110		WBC50202	23.8 15/16"	D/I	(2) T/M	
D10557961	✓	—						(1) T/A	
S93616290			BRD120110		WBC50202	23.8 15/16"	D/I	(2) T/M	
D10957957	✓	✓	BRR125610	Sol					
CMD18338893	—	✓							
D10957957	✓	✓	BRR125610	Sol					
CMD18338893	—	✓	BRR125710	Sol					
CMD18338893	—	✓							
D10557961	✓	—							
D10557961	✓	—							
ESCORT									
			BRR121410	Sol					
					WBC50261	17.4 11/16"	D/I	(1) T/M (2) T/A	
					WBC50261	17.4 11/16"	D/I	(1) T/M (2) T/A	
D66375140	✓	—	BRR121410	Sol				(1) T/M (2) T/A	
EXCURSION									
D75776260	✓	—	BRR121810	Vent				(1) zapatas de freno de estacionamiento	
			S77121920	(1)					
EXPEDITION									
D71175840	✓	✓	BRR121110	Sol				(1) con control de velocidad (2) sin control de velocidad (3) zapatas de freno de estacionamiento	
			S75215170	(3)					
D87975840	✓	✓	BRR123010	Sol				(1) zapatas de freno de estacionamiento	
			S75215170	(1)					
D87975840	✓	✓	BRR123010	Sol				(1) hasta 24/05/2001 (2) de 25/05/2001 a 18/03/2002 (3) zapatas de freno de estacionamiento	
			S75215170	(3)					
D93578380	✓	—	BRR122010	Vent				(1) sin control de tracción (2) con control de tracción	
D12798395	✓	✓	BRR123510	Vent					
D12798395	✓	✓	BRR123510	Vent					
D12798395	✓	✓	BRR123510	Vent					
D12798395	✓	✓	BRR123510	Vent					
D12798395	✓	✓	BRR123510	Vent					



			EJE DELANTERO						
			PASTILLA 		ROTOR 	TIPO	CILINDRO MAESTRO	MEDIDA mm - in	
FORD									
EXPEDITION cont.									
	4X4	2001	D70275760	✓	✓			BMC10174 ⁽¹⁾ 31.7 1 1/4" BMC10173 ⁽²⁾ 31.7 1 1/4"	
		2002	D70275760	✓	✓			BMC10260 ⁽²⁾ 28.5 1 1/8" BMC10261 ⁽³⁾ 28.5 1 1/8"	
	03-06	D93478370	✓	-	BFR128210	Vent	BMC10260 28.5 1 1/8"	BMC10261 28.5 1 1/8"	
							2007	D12788394	✓
EXPLORER									
		91-92	D2497125A	✓	-	BFR123410	Vent	BMC10489 25.4 1"	
	4X2	93-94	D2497125A	✓	-	BFR123710	Vent	BMC10489 25.4 1"	
									4X4
	4X2	95-97	D65275320	✓	✓	BFR124610	Vent	BMC10160 ⁽²⁾ 27.0 1 1/16"	
						BFR124620 ⁽¹⁾	Vent		
	4X4					BFR126610	Vent	BMC10159 ⁽³⁾ 27.0 1 1/16"	
	4X2	98-01	D65275320	✓	✓	BFR124610	Vent	BMC10189 ⁽²⁾ 27.0 1 1/16"	
						BFR124620 ⁽¹⁾	Vent		
	4X4					BFR126610	Vent	BMC10191 ⁽⁴⁾ 27.0 1 1/16"	
		02-03	D83377060	✓	✓	BFR120510	Vent	BMC10189 ⁽¹⁾ 27.0 1 1/16"	
								04-05	D83377060
		06-10	D11588268	✓	✓	BFR129910	Vent	BMC10502 27.0 1 1/16"	
		11-12	D15088715	✓	✓	BFR221710	Vent		
		13-19	D15088715	✓	✓	BFR221710	Vent		
	HD Brakes	13-14	D16118824	✓	✓				
	15-16	D16118824	✓	✓					
	17-19	D16118824	✓	✓					
Sport	98-01	D65275320	✓	✓	BFR124610	Vent			
					BFR124620 ⁽¹⁾	Vent			
	02-03	D83377060	✓	✓	BFR128010	Vent	BMC10190 ⁽¹⁾ 27.0 1 1/16"		
BFR128020 ⁽³⁾					Vent	BMC10191 ⁽²⁾ 27.0 1 1/16"			
V6 BiTurbo	2015	D16118824	✓	✓					

PASTILLA / ZAPATA		EJE TRASERO		ROTOR / TAMBOR		TIPO	CILINDRO DE RUEDA	MEDIDA mm - in	I / D	i
SM	CM									
FORD										
EXPEDITION cont.										
D87975840	✓	✓	BRR121110	Sol						(1) hasta 24/05/2001
			S75215170							(2) de 25/05/2001 a 18/03/2002
D87975840	✓	✓	BRR121110	Sol						(2) sin control de tracción
			S75215170							(3) con control de tracción
D93578380	✓	—	BRR122010	Vent						
D12798395	✓	✓	BRR123510	Vent						
EXPLORER										
S58120890			BRD122710		WBC50269	22.2	7/8"	D/I		
S58120890			BRD122710		WBC50269	22.2	7/8"	D/I		
S58120890			BRD122710		WBC50269	22.2	7/8"	D/I		
D6677545A	✓	—	BRR121010	Sol						(1) incluye baleros cónicos FAG
			S70114840	(4)						(2) sin control de velocidad
										(3) con control de velocidad
										(4) zapatas de freno de estacionamiento
D6677545A	✓	—	BRR121010	Sol						(1) incluye baleros cónicos FAG
			S70114840	(5)						(2) 4 puertas
										(3) 2 puertas, sin control de velocidad
										(4) 2 puertas, con control de velocidad y con accionamiento electrónico
										(5) zapatas de freno de estacionamiento
D88177580 (2)	✓	✓	BRR122510	Sol						(1) T/A sin control de tracción
D8817758A (3)	✓	✓	S79115330 (4)							(2) clip chico
										(3) clip Grande
D88177580 (1)	✓	✓	BRR122510	Sol						(4) zapatas de freno de estacionamiento
D8817758A (2)	✓	✓	S79115330 (3)							(1) clip chico
										(2) clip Grande
										(3) zapatas de freno de estacionamiento
D11098214	✓	✓	BRR122510	Sol						
			S79115330 (1)							(1) zapatas de freno de estacionamiento
D13778488	✓	✓	BRR123210	Sol						
CMD17548970	—	✓	BRR123210	Sol						
D16128825	✓	✓								
D13778488	✓	✓								
CMD17548970	—	✓								
D6677545A	✓	—	BRR121010	Sol						(1) incluye baleros cónicos FAG
			S70114840 (2)							(2) zapatas de freno de estacionamiento
D88177580 (4)	✓	✓	BRR121010	Sol						(1) sin control de velocidad
										(2) con control de velocidad
										(3) con rodamientos incluidos
D8817758A (5)	✓	✓								(4) clip chico
										(5) clip Grande
D16128825	✓	✓								



			EJE DELANTERO							
			PASTILLA 		ROTOR 	TIPO	CILINDRO MAESTRO	MEDIDA mm - in		
FORD										
EXPLORER cont.										
Sport	3.5 Eco boost	17-19	D16118824	✓	✓					
Sport Track		07-10	D11588268	✓	✓	BFR129910	Vent	BMC10502	27.0	1 1/16"
F-150 / F-250										
		79-83	D0507013A	✓	—	BFR126410 BFR126420 ⁽¹⁾	Vent Vent	BMC10136	25.4	1"
		84-86	D0507013A	✓	—	BFR126410 BFR126420 ⁽²⁾	Vent Vent	BMC10136 ⁽¹⁾	25.4	1"
		87-93	D0507013A	✓	—	BFR126410 BFR126420 ⁽¹⁾	Vent Vent	BMC10478	27.0	1 1/16"
		94-96	D63275030	✓	—	BFR123810 BFR123820 ⁽¹⁾ BFR123910 BFR123920 ⁽¹⁾	Vent Vent Vent Vent	BMC10478 ⁽²⁾ BMC10501 ⁽³⁾	27.0	1 1/16"
		97-99	D67975580	✓	✓	BFR124810 BFR124820 ⁽¹⁾ BFR125010 ⁽²⁾	Vent Vent Vent	BMC10478 ⁽³⁾ BMC10146 ⁽⁴⁾	27.0	1 1/16"
		00-04	D67975580	✓	✓	BFR124710 BFR124720 ⁽²⁾	Vent Vent	BMC10350 ⁽¹⁾	27.0	1 1/16"
		05-08	D67975580	✓	✓	BFR124710 BFR124720 ⁽¹⁾	Vent Vent	BMC10273	28.5	1 1/8"
		2009	D10117915	✓	✓	BFR120910 BFR120920 ⁽¹⁾	Vent Vent	BMC10389	28.5	1 1/8"
F-150										
		2010	D14148528	✓	✓	BFR124310	Vent	BMC10446	30.1	1 3/16"
		2011	D14148528	✓	✓	BFR124310	Vent	BMC10544	30.1	1 3/16"
		12-13	D14148528	✓	✓	BFR124310	Vent	BMC10544	30.1	1 3/16"
		2014	D17708528	✓	—	BFR124310	Vent	BMC10544	30.1	1 3/16"
		15-16	D17708528	✓	—	BFR124310	Vent			
		17->	D14148528	✓	✓	BFR124310	Vent			
F-250										
SD	4X4	2010	D10697974	✓	✓	BFR125610	Vent	BMC10413 ⁽¹⁾ BMC10410 ⁽²⁾ BMC10409 ⁽³⁾	38.1	1 1/2"
		11-12	D10697974	✓	✓	BFR125610	Vent			

EJE TRASERO								i
PASTILLA / ZAPATA	SM	CM	ROTOR / TAMBOR	TIPO	CILINDRO DE RUEDA	MEDIDA mm - in	I / D	
FORD								
EXPLORER cont.								
D13778488	✓	✓						
D11098214	✓	✓	BRR122510 S79115330	Sol				(1) zapatas de freno de estacionamiento
F-150 / F-250								
			BRD123910		WBC50126 WBC50127	23.8 15/16" 23.8 15/16"	Izq Der	(1) con rodamientos incluidos
			BRD123910		WBC50126 WBC50127	23.8 15/16" 23.8 15/16"	Izq Der	(1) con frenos de poder (2) con rodamientos incluidos
			BRD123910		WBC50126 WBC50127	23.8 15/16" 23.8 15/16"	Izq Der	(1) con rodamientos incluidos
					WBC50126 WBC50127	23.8 15/16" 23.8 15/16"	Izq Der	(1) incluye baleros cónicos (2) sin control de velocidad (3) con control de velocidad
S72321820			BRD122810 (2)		WBC50289 WBC50290	25.4 1" 25.4 1"	Izq Der	(1) incluye baleros cónicos (2) barrenos de 14.6 mm (3) sin control de velocidad (4) con control de velocidad
S72321820			BRD122810		WBC50289 WBC50290	25.4 1" 25.4 1"	Izq Der	(2) incluye baleros cónicos (1) con control de velocidad
S72321820			BRD122810					
S72321820			BRD122810					(1) incluye baleros cónicos (1) incluye balero doble
F-150								
D10127916	✓	✓	BRR122210	Vent				
D10127916	✓	✓	BRR122210	Vent				
D16028816	✓	✓	BRR125210	Vent				
D16028816	✓	✓	BRR125210	Vent				
			BRR126210 (1)	Vent				(1) freno eléctrico de estacionamiento
D16028816 (2)	✓	✓	BRR125210 (2)	Vent				(2) freno de estacionamiento etandar
			BRR126210 (1)	Vent				(1) freno eléctrico de estacionamiento
D16028816 (2)	✓	✓	BRR125210 (2)	Vent				(2) freno de estacionamiento etandar
F-250								
D10677973	✓	✓						(1) Diesel con booster hidráulico, sin control de freno integral (2) Diesel con booster hidráulico, con control de freno integral (3) gasolina sin control de freno integral (1) zapatas de freno de estacionamiento
			S85421920 (1)					
D13348652	✓	-						(1) zapatas de freno de estacionamiento
			S85421920 (1)					



			EJE DELANTERO						MEDIDA mm - in	
			PASTILLA			ROTOR	TIPO	CILINDRO MAESTRO		
FORD										
F-250 cont.										
		2013	D13338782	✓	—					
		14-16	D16808909	✓	—					
		17->	D16808909	✓	—					
Crew Cab	4X4	10-12	D10697974	✓	✓	BFR125610	Vent			
		2013	D13338782	✓	—					
		14-16	D16808909	✓	—					
F-350										
		76-79	D12070540	✓	—	BFR122510	Vent			
		80-82	D12070540	✓	—	BFR122510	Vent	BMC10452	27.0	1 1/8"
		83-86	D12070540	✓	—	BFR122510	Vent	BMC10464	28.5	1 1/8"
		87-89	D12070540	✓	—	BFR122510	Vent	BMC10479	28.5	1 1/8"
		1990	D12070540	✓	—	BFR122510	Vent	BMC10479	28.5	1 1/8"
		91-92	D12070540	✓	—	BFR122510	Vent	BMC10480	28.5	1 1/8"
		93-94	D12070540	✓	—	BFR122510	Vent	BMC10480 ⁽¹⁾ BMC10145 ⁽²⁾	28.5	1 1/8"
Super Duty		95-96	D65575350	✓	—	BFR124010	Vent	BMC10480 ⁽¹⁾ BMC10145 ⁽²⁾	28.5	1 1/8"
		1997	D65575350	✓	—	BFR124010	Vent	BMC10175 ⁽¹⁾ BMC10174 ⁽²⁾	31.7	1 1/4"
		98-99	D75676250	✓	—	BFR125410	Vent	BMC10175 ⁽¹⁾ BMC10174 ⁽²⁾	31.7	1 1/4"
		00-04	D75676250	✓	—	BFR125410	Vent	BMC10212 ⁽¹⁾ BMC10211 ⁽²⁾	34.9	1 3/8"
		2005	D75676250	✓	—	BFR125410 BFR125420	Vent Vent	BMC10309 ⁽¹⁾ BMC10351 ⁽²⁾ BMC10310 ⁽³⁾ BMC10352 ⁽⁴⁾	38.1	1 1/2"

		EJE TRASERO						
PASTILLA / ZAPATA			ROTOR / TAMBOR	TIPO	CILINDRO DE RUEDA		MEDIDA mm - in	I / D

FORD

F-250 cont.

D13348652	✓	-						
			S85421920	(1)				(1) zapatas de freno de estacionamiento
D16918918	✓	-						
			S10431705	(1)				(1) zapatas de freno de estacionamiento
D16918918	✓	-						
D10677973	✓	✓						
			S85421920					
D13348652	✓	-						
			S85421920					
D16918918	✓	-						
			S10431705					

F-350

					WBC50219	26.9	1 1/16"	Izq	
					WBC50220	26.9	1 1/16"	Der	
					WBC50133	28.5	1 1/8"	Izq	
					WBC50134	28.5	1 1/8"	Der	
					WBC50133	(1) 28.5	1 1/8"	Izq	(1) zapatas de 12" x 3"
					WBC50134	(1) 28.5	1 1/8"	Der	
					WBC50223	(2) 30.1	1 3/16"	Izq	(2) zapatas de 12" x 3 1/2"
					WBC50222	(2) 30.1	1 3/16"	Der	
					WBC50223	30.1	1 3/16"	Izq	
					WBC50222	30.1	1 3/16"	Der	
S58321710					WBC50223	30.1	1 3/16"	Izq	
					WBC50222		1 3/16"	Der	
S58321710					WBC50223	30.1	1 3/16"	Izq	(1) sin control de velocidad
					WBC50222	30.1	1 3/16"	Der	(2) con control de velocidad
S58321710					WBC50223	30.1	1 3/16"	Izq	(1) sin control de velocidad
					WBC50222	30.1	1 3/16"	Der	(2) con control de velocidad
S58321710					WBC50223	30.1	1 3/16"	Izq	(1) sin control de velocidad
					WBC50222	30.1	1 3/16"	Der	(2) con control de velocidad
S58321710					WBC50223	30.1	1 3/16"	Izq	(1) sin control de velocidad
					WBC50222	30.1	1 3/16"	Der	(2) con control de velocidad
S58321710					WBC50223	30.1	1 3/16"	Izq	(1) sin control de velocidad
					WBC50222	30.1	1 3/16"	Der	(2) con control de velocidad
S58321710					WBC50223	30.1	1 3/16"	Izq	(1) Diesel, con booster hidráulico, con control de freno integral
					WBC50222	30.1	1 3/16"	Der	(2) Diesel, con booster hidráulico, sin control de freno integral
									(3) gasolina sin control de freno integral
									(4) gasolina con control de freno integral





			EJE DELANTERO															
			PASTILLA	SM	CM	ROTOR	TIPO	CILINDRO MAESTRO		MEDIDA mm - in								
FORD																		
F-350 cont.																		
	2006	D10697974	✓	✓	BFR126810	Vent	BMC10309 ⁽¹⁾	38.1	1 1/2"	BMC10351 ⁽²⁾	38.1	1 1/2"	BMC10310 ⁽³⁾	33.3	1 5/16"	BMC10352 ⁽⁴⁾	33.3	1 5/16"
	07-08	D10697974	✓	✓	BFR126810	Vent	BMC10413 ⁽¹⁾	38.1	1 1/2"	BMC10410 ⁽²⁾	38.1	1 1/2"	BMC10409 ⁽³⁾	33.3	1 5/16"			
	08-10	D10697974	✓	✓	BFR127110	Vent	BMC10413 ⁽¹⁾	38.1	1 1/2"	BMC10410 ⁽²⁾	38.1	1 1/2"	BMC10409 ⁽³⁾	33.3	1 5/16"			
	2011	D10697974	✓	✓	BFR127110	Vent												
	2012	D10697974	✓	✓	BFR127110	Vent												
	13-16	D16808909	✓	—	BFR222610	Vent												
	17->	D16808909	✓	—	BFR222610	Vent												
	F-450 / F-550																	
Super Duty	97-98																	
	1999	D77776440	✓	—			BMC10212 ⁽¹⁾	34.9	1 3/8"	BMC10211 ⁽²⁾	34.9	1 3/8"						
	00-04	D77776440	✓	—	BFR220410 ⁽³⁾	Vent	BMC10212 ⁽¹⁾	34.9	1 3/8"	BMC10211 ⁽²⁾	34.9	1 3/8"						
	05-06	D10667972	✓	—	BFR220610	Vent	BMC10309 ⁽¹⁾	38.1	1 1/2"	BMC10351 ⁽²⁾	38.1	1 1/2"	BMC10310 ⁽³⁾	33.3	1 5/16"	BMC10352 ⁽⁴⁾	33.3	1 5/16"
	07-10	D10667972	✓	—	BFR220610	Vent	BMC10413 ⁽¹⁾	38.1	1 1/2"	BMC10410 ⁽²⁾	38.1	1 1/2"	BMC10409 ⁽³⁾	33.3	1 5/16"			





		EJE TRASERO							
PASTILLA / ZAPATA			 ROTOR / TAMBOR	TIPO	 CILINDRO DE RUEDA		MEDIDA mm - in	I / D	
FORD									
F-350 cont.									
S58321710					WBC50223	30.1	1 3/16"	Izq	(1) Diesel, con booster hidráulico, con control de freno integral (2) Diesel, con booster hidráulico, sin control de freno integral (3) gasolina sin control de freno integral (4) gasolina con control de freno integral
					WBC50222	30.1	1 3/16"	Der	
S58321710					WBC50223	30.1	1 3/16"	Izq	(1) Diesel con booster hidráulico, sin control de freno integral
					WBC50222	30.1	1 3/16"	Der	(2) Diesel con booster hidráulico, con control de freno integral (3) sin control de freno integral
D10687973	✓	—	BRR125310	Vent					(1) Diesel con booster hidráulico, sin control de freno integral (3) sin control de freno integral (2) Diesel con booster hidráulico, con control de freno integral (4) zapatas de freno de estacionamiento
			S85421920	(4)					
D13348652	✓	—	BRR125310	Vent					(1) zapatas de freno de estacionamiento
			S85421920	(1)					
D13348652	✓	—	BRR125310	Vent					(1) zapatas de freno de estacionamiento
D16918918	✓	—							
			S85421920	(1)					
D16918918	✓	—	BRR126410	Vent					(1) zapatas de freno de estacionamiento
			S10431705	(1)					
D16918918	✓	—	BRR126410	Vent					
F-450 / F-550									
									(1) zapatas de freno de estacionamiento
			S64620860	(1)					
D77776440	✓	—	BRR121210	Vent					(1) sin control de velocidad (2) con control de velocidad (3) zapatas de freno de estacionamiento
			S77221930	(3)					
D77776440	✓	—	BRR121210	(4) Vent					(1) sin control de velocidad (2) con control de velocidad (3) 8 barrenos (4) 10 barrenos (5) zapatas de freno de estacionamiento
			S77221930	(5)					
D10667972	✓	—	BRR124710	Vent					(1) Diesel, con booster hidráulico, con control de freno integral (2) Diesel, con booster hidráulico, sin control de freno integral (3) sin control de freno integral (4) con control de freno integral
D10667972	✓	—	BRR124710	Vent					(1) Diesel, con booster hidráulico, sin control de freno integral (2) Diesel, con booster hidráulico, con control de freno integral (3) sin control de freno integral



			EJE DELANTERO						
			PASTILLA 		ROTOR 	TIPO	CILINDRO MAESTRO	MEDIDA mm - in	
FORD									
F-450 / F-550 cont.									
		11-12	D10667972	✓	—	BFR220610	Vent		
		13-16	D10667972	✓	—	BFR220610	Vent		
		17->	D20189249	✓	—	BFR222610	Vent		
F-600									
		86-88	D22471410	✓	—				
FAIRMONT									
		78-81					BMC10180	22.2 7/8"	
		82-83					BMC10469 ⁽¹⁾ BMC10457 ⁽²⁾	21.0 53/64" 21.0 53/64"	
FIESTA									
HB		98-00	D11968316 ⁽¹⁾	✓	—	BFR126210	Sol	BMC10511 ⁽³⁾ 22.2 7/8"	
			D64975290 ⁽²⁾	✓	—	BFR126110	Vent	BMC10110 ⁽⁴⁾ 23.8 15/16"	
	2001	D14608660	✓	✓	BFR126110	Vent	BMC10511 22.2 7/8"		
	03-07	D00010030 ⁽¹⁾	✓	—	BFR126110	Vent	BMC10110 23.8 15/16"		
		D11408251 ⁽²⁾	✓	✓					
11-19	D14548653	✓	✓	BFR221110	Vent	BMC10519 ⁽¹⁾ 20.6 13/16" BMC10392 ⁽²⁾ 20.6 13/16"			
	Sedán	05-07	D11408251	✓	✓	BFR126110	Vent	BMC10110 23.8 15/16"	
Sedán	T/M	08-10	D11408251	✓	✓	BFR126110	Vent	BMC10110 23.8 15/16"	
	T/A	2008	D11758289	✓	✓	BFR126310	Vent	BMC10110 23.8 15/16"	
		09-10	D14608660	✓	✓	BFR126110	Vent	BMC10110 23.8 15/16"	
		11-19	D14548653	✓	✓	BFR221110	Vent	BMC10519 ⁽¹⁾ 20.6 13/16" BMC10392 ⁽²⁾ 20.6 13/16"	
Ikon	Sedán	01-07	D14608660	✓	✓	BFR126110	Vent	BMC10110 23.8 15/16"	
		11-12							
	HB	12-15	D16388865	✓	✓	BFR127810	Vent	BMC10573 23.8 15/16"	

		EJE TRASERO							
PASTILLA / ZAPATA			TIPO		MEDIDA mm - in		I / D		
FORD									
F-450 / F-550 cont.									
D10667972	✓	—	BRR124710 Vent					(1) zapatas de freno de estacionamiento	
			S85421920 (1)						
D10667972	✓	—						(1) zapatas de freno de estacionamiento	
			S10431705 (1)						
D20189249	✓	—							
F-600									
FAIRMONT									
				WBC50135	20.6	13/16"	Izq		
				WBC50136	20.6	13/16"	Der		
				WBC50135	20.6	13/16"	Izq	(1) tambor de 9"	
				WBC50136	20.6	13/16"	Der	(2) con booster	
FIESTA									
S10002209			BRD123610	WBC50108 (3)	17.8	45/64"	D/I	(1) pastilla chica (2) pastilla Grande (3) con motor 1.3L	
			BRD123620 (5)	WBC50109 (4)	19.1	3/4"	D/I	(4) con motor 1.4L (5) incluye baleros cónicos	
S10002209			BRD123610 BRD123620 (1)	WBC50108	17.8	45/64"	D/I	(1) incluye baleros cónicos	
S10002209			BRD123610 BRD123620 (3)	WBC50109	19.1	3/4"	D/I	(1) pastilla corta (2) pastilla larga (3) incluye baleros cónicos	
S98414370			BRD120410	WBC50206	19.1	3/4"	D/I	(1) T/M (2) T/A	
S10002209			BRD123610 BRD123620 (1)	WBC50109	19.1	3/4"	D/I	(1) incluye baleros cónicos	
S99316640			BRD123210 BRD123220 (1)	WBC50109	19.1	3/4"	D/I	(1) con balero doble integrado	
S99316640			BRD123210 BRD123220 (1)	WBC50109	19.1	3/4"	D/I	(1) con balero doble integrado	
S99316640			BRD123210 BRD123220 (1)	WBC50109	19.1	3/4"	D/I	(1) con balero doble integrado	
S98414370			BRD120410	WBC50206	19.1	3/4"	D/I	(1) T/M (2) T/A	
S10002209			BRD123610 BRD123620 (1)	WBC50109	19.1	3/4"	D/I	(1) incluye baleros cónicos	
S10372209			BRD123610 BRD123620 (1)	WBC50354	19.1	3/4"	D/I	(1) incluye baleros cónicos	



		 2012... 2013... 2014...	EJE DELANTERO								
			 PASTILLA			 ROTOR	TIPO	CILINDRO MAESTRO	MEDIDA mm - in		
FORD											
FIESTA cont.											
ST		2008	D11758289	✓	✓	BFR126310	Vent				
		14-16	D17308954	✓	✓						
FIGO											
		16-20	D14548653	✓	✓	BFR221110	Vent				
FIVE HUNDRED											
		05-07	D10707975	✓	-			BMC10312 ⁽¹⁾	25.4	1"	
								BMC10303 ⁽²⁾	25.4	1"	
FOCUS											
		2000	D81676900	✓	-	BFR126310	Vent	BMC10231 ⁽¹⁾	23.8	15/16"	
								BMC10276 ⁽²⁾	23.8	15/16"	
		2001	D81676900	✓	-	BFR126310	Vent	BMC10231 ⁽¹⁾	23.8	15/16"	
								BMC10236 ⁽²⁾	23.8	15/16"	
								BMC10276 ⁽³⁾	23.8	15/16"	
		02-03	D81676900	✓	-	BFR126310	Vent	BMC10231 ⁽¹⁾	23.8	15/16"	
								BMC10236 ⁽²⁾	23.8	15/16"	
								BMC10276 ⁽³⁾	23.8	15/16"	
		2004	D81676900	✓	-	BFR126310	Vent	BMC10231 ⁽¹⁾	23.8	15/16"	
						BMC10276 ⁽²⁾	23.8	15/16"			
2005	D10447947	✓	✓	BFR125710	Vent	BMC10231 ⁽¹⁾	23.8	15/16"			
						BMC10276 ⁽²⁾	23.8	15/16"			
06-07	D10447947	✓	✓	BFR125710	Vent	BMC10276	23.8	15/16"			
07-11	D10447947	✓	✓	BFR410410	Vent	BMC10383 ⁽¹⁾	23.8	15/16"			
12-14	D10447947	✓	✓	BFR221610	Vent	BMC10545	25.4	1"			
15-18	D10447947	✓	✓	BFR221610	Vent	BMC10545	25.4	1"			
RS		10-11	CMD13228434	-	✓						
Ecoboost	2.3T	16-17						BMC10545	25.4	1"	
ST		07-11				BFR410710	Vent				
Ecoboost	2.0T	13-14	CMD17718896	-	✓	BFR410710	Vent				
		15-18	CMD17718896	-	✓						
SVT		02-03					BMC10236 ⁽¹⁾	23.8	15/16"		
							BMC10276 ⁽²⁾	23.8	15/16"		
FREESTAR											
		04-05	D10227927	✓	-	BFR120310	Vent	BMC10272 ⁽¹⁾	27.0	1 1/16"	

PASTILLA / ZAPATA		ROTOR / TAMBOR		TIPO	CILINDRO DE RUEDA	MEDIDA mm - in	I / D	i
FORD								
FIESTA cont.								
S99316640			BRD123210 BRD123220 (1)					(1) con balero doble integrado
FIGO								
S98414370			BRD120410		WBC50207	20.6 13/16"	D/I	
FIVE HUNDRED								
D10717976	✓	-	BRR123210	Sol				(1) sin control de tracción (2) con control de tracción
FOCUS								
S74715130			BRD123210 BRD123220 (3)		WBC50154	20.6 13/16"	D/I	(1) sin ABS sin control de tracción (2) con ABS (3) con balero doble integrado
S74715130			BRD123210 BRD123220 (4)		WBC50154	20.6 13/16"	D/I	(1) sin ABS sin control de tracción (2) con ABS, control de tracción (4 puertos) (3) con ABS 2 (puertos) (4) con balero doble integrado
S74715130			BRD123210 BRD123220 (4)		WBC50247	22.2 7/8"	D/I	(1) sin ABS sin control de tracción (2) con ABS, con control de tracción (4 puertos) (3) con ABS 2 (puertos) (4) con balero doble integrado
S74715130			BRD123210 BRD123220 (3)		WBC50247	22.2 7/8"	D/I	(1) sin ABS, sin control de tracción (2) con ABS 2 (puertos) (3) con balero doble integrado
S74715130			BRD123210 BRD123220 (3)		WBC50247	22.2 7/8"	D/I	(1) sin ABS sin control de tracción (2) con ABS 2 (puertos) (3) con balero doble integrado
S74715130			BRD123210 BRD123220 (1)		WBC50247	22.2 7/8"	D/I	(1) con balero doble integrado
D10957957	✓	✓	BRR410410	Sol				(1) con ABS, y control de estabilidad
D10957957	✓	✓	BRR125110	Sol				
S10041674			BRD120510		WBC50355	20.6 13/16"	D/I	
D10957957	✓	✓	BRR125110	Sol				
D10957957	✓	✓	BRR410410	Sol				
D10957957	✓	✓	BRR125110	Sol				
D10957957	✓	✓	BRR125110	Sol				(1) con ABS (4 puertos) (2) con ABS (2 puertos)
FREESTAR								
D10217926	✓	-	BRR122310	Vent				(1) con control de tracción y control dinámico



				EJE DELANTERO		TIPO	CILINDRO MAESTRO	MEDIDA	
				PASTILLA	ROTOR			mm - in	
FORD									
FREESTAR cont.									
		06-07	D10227927	✓	—	BFR120310	Vent	BMC10432 ⁽¹⁾	27.0 1 1/16"
FUSION									
Sport		2006	D11648277	✓	✓	BFR128810	Vent	BMC10359 ⁽¹⁾	20.6 13/16"
		07-09	D11648277	✓	✓	BFR128810	Vent	BMC10359 ⁽¹⁾	20.6 13/16"
		10-12	D11648277	✓	✓	BFR128810	Vent	BMC10428	22.2 7/8"
		13-16	D16538882	✓	✓	BFR221910	Vent		
		17-20	D16538882	✓	✓	BFR221910	Vent		
		10-12	D11648277	✓	✓	BFR128810	Vent	BMC10428	22.2 7/8"
Hibrido		17-20	D16538882	✓	✓				
GHIA									
		91-94	D2577106A	✓	—	BFR120110	Vent	BMC10463	19.7 & 28.6
GRAND MARQUIS									
		1982							
		83-84						BMC10469 ⁽²⁾	21.0 53/64"
								BMC10457	21.0 53/64"
		98-02	D74876170	✓	—			BMC10220	25.4 1"
KA									
		01-03	D11408251 ⁽¹⁾	✓	✓	BFR126110	Vent	BMC10492	22.2 7/8"
			D00010030 ⁽²⁾	✓	—				
		04-08	D11408251 ⁽¹⁾	✓	✓	BFR126110	Vent		
			D00010030 ⁽²⁾	✓	—				
LOBO									
		96-99	D67975580	✓	✓	BFR124810 ⁽¹⁾	Vent	BMC10478 ⁽³⁾	27.0 1 1/16"
						BFR124820 ⁽⁵⁾	Vent		
						BFR125010 ⁽²⁾	Vent		
		00-01	D67975580	✓	✓	BFR124710	Vent	BMC10104 ⁽¹⁾	31.7 1 1/4"
						BFR124720 ⁽⁴⁾	Vent		
		2002	D67975580	✓	✓	BFR124710	Vent	BMC10173 ⁽¹⁾	31.7 1 1/4"
						BFR124720 ⁽³⁾	Vent		
		2003	D67975580	✓	✓	BFR124710	Vent		
						BFR124720 ⁽¹⁾	Vent		
		2004	D10117915	✓	✓	BFR120910 ⁽¹⁾	Vent		
						BFR120920 ⁽²⁾	Vent		
						BFR221510 ⁽³⁾	Vent		
		2005	D10117915	✓	✓	BFR120910 ⁽¹⁾	Vent	BMC10273	28.5 1 1/8"
						BFR120920 ⁽²⁾	Vent		
						BFR221510 ⁽³⁾	Vent		





PASTILLA / ZAPATA		EJE TRASERO		ROTOR / TAMBOR		TIPO	CILINDRO DE RUEDA	MEDIDA mm - in		I / D	i
FORD											
FREESTAR cont.											
D10217926	✓	—	BRR122310	Sol		Vent					(1) sin control de tracción
FUSION											
D11618272	✓	✓	BRR123110	Sol							(1) con ABS
D11618272	✓	✓	BRR123110	Sol							(1) sin control de estabilidad
D11618272	✓	✓	BRR123110	Sol							
CMD18338893	—	✓	BRR125410	Sol							
CMD18338893	—	✓	BRR125410	Sol							
D11618272	✓	✓	BRR123110	Sol							
CMD18338893	—	✓	BRR125710	Sol							
GHIA											
S50113500							WBC50242	22.2	7/8"	Izq	
							WBC50243	22.2	7/8"	Der	
GRAND MARQUIS											
							WBC50232	23.8	15/16"	D/I	
							WBC50232	(1) 23.8	15/16"	D/I	(1) tambor de 9" (2) con booster
KA											
S10002209			BRD123610 BRD123620				WBC50109	19.1	3/4"	D/I	(1) pastilla larga (2) pastilla corta
S10002209			BRD123610 BRD123620				WBC50109	19.1	3/4"	D/I	(1) pastilla larga (2) pastilla corta
LOBO											
S72321820			BRD122810				WBC50289	25.4	1"	Izq	(1) ABS en eje trasero (2) ABS en las 4 ruedas (3) sin control de velocidad (4) con control de velocidad (5) ABS en eje trasero, incluye baleros cónicos
							WBC50290	25.4	1"	Der	
D71175840	✓	✓	BRR123010 S75215170 (3)	Sol							(1) sin control de velocidad (2) con control de velocidad (3) zapatas de freno de estacionamiento
S72321820			BRD122810								(4) incluye baleros cónicos
D71175840	✓	✓	BRR123010 S75215170 (2)	Sol							(1) con control de velocidad (2) zapatas de freno de estacionamiento (3) incluye baleros cónicos
D71175840	✓	✓	BRR123010 S75215170 (2)	Sol							(1) incluye baleros cónicos (2) zapatas de freno de estacionamiento
D10127916	✓	✓	BRR122210 S75215170 (4)	Vent							(1) 4X2 (2) 4X2 con balero doble incluido (3) 4X4 (4) zapatas de freno de estacionamiento
D10127916	✓	✓	BRR122210 S75215170 (4)	Vent							(1) 4X2 (2) 4X2 con balero doble incluido (3) 4X4 (4) zapatas de freno de estacionamiento



			EJE DELANTERO									
			PASTILLA	SM	CM	ROTOR	TIPO	CILINDRO MAESTRO	MEDIDA mm - in			
FORD												
LOBO cont.												
		06-08	D10837915	✓	✓	BFR120910 ⁽¹⁾	Vent	BMC10273	28.5	1 1/8"		
						BFR120920 ⁽²⁾	Vent					
						BFR221510 ⁽³⁾	Vent					
			2009	D13927915	✓	—	BFR120910 ⁽¹⁾	Vent	BMC10389	28.5	1 1/8"	
							BFR120920 ⁽²⁾	Vent				
			2010	D14148528	✓	✓	BFR124310	Vent	BMC10446	30.1	1 3/16"	
			2011	D14148528	✓	✓	BFR124310	Vent	BMC10544	30.1	1 3/16"	
			2012	D14148528	✓	✓	BFR124310	Vent	BMC10544	30.1	1 3/16"	
	2013	D14148528	✓	✓	BFR124310	Vent	BMC10544	30.1	1 3/16"			
	14-17	D17708528	✓	—	BFR124310	Vent	BMC10544	30.1	1 3/16"			
	18->	D14148528	✓	✓								
LTD												
		82-86						BMC10469 ⁽¹⁾	21.0	53/64"		
								BMC10457 ⁽²⁾	21.0	53/64"		
MICROBUS												
		86-87	D12070540	✓	—	BFR122510	Vent					
		89-90	D12070540	✓	—	BFR122510	Vent	BMC10479	28.5	1 1/8"		
		91-96	D12070540	✓	—	BFR122510	Vent	BMC10480	28.5	1 1/8"		
MONDEO												
		01-07	D91077890	✓	✓	BFR126910	Vent	BMC10584	23.8	15/16"		
								BMC10316 ⁽¹⁾	23.8	15/16"		
MUSTANG												
		66-73					Tam					
		1979						BMC10180	22.2	7/8"		
		80-81							BMC10180	22.2	7/8"	
		82-86							BMC10457 ⁽¹⁾	21.0		
										BMC10469 ⁽²⁾	21.0	53/64"
		87-93								BMC10481	21.0	8.302

PASTILLA / ZAPATA		SM CM		ROTOR / TAMBOR	TIPO	CILINDRO DE RUEDA	MEDIDA mm - in	I / D	i
FORD									
LOBO cont.									
D10127916	✓	✓	BRR122210	Vent					(1) 4X2 (2) 4X2 con balero doble incluido (3) 4X4 (4) zapatas de freno de estacionamiento
			S75215170	(4)					
D10127916	✓	✓	BRR122210	Vent					(1) zapatas de freno de estacionamiento
			S75215170	(1)					
D10127916	✓	✓	BRR122210	Vent					
			S75215170	(1)					
D10127916	✓	✓	BRR122210	Vent					
			S75215170	(1)					
D10127916	✓	✓	BRR122210	Vent					
D16028816	✓	✓							
			S75215170	(1)					
D16028816	✓	✓	BRR125210	Vent					
D16028816	✓	✓	BRR125210	Vent					
			BRR126210	Vent					
LTD									
						WBC50135	20.6 13/16"	Izq	(1) tambor de 9"
						WBC50136	20.6 13/16"	Der	(2) con booster
MICROBUS									
						WBC50223	30.1 1 3/16"	Izq	
						WBC50222	30.1 1 3/16"	Der	
S58321710						WBC50223	30.1 1 3/16"	Izq	
						WBC50222	30.1 1 3/16"	Der	
MONDEO									
D91177900	✓	✓	BRR121510	Sol					(1) con control de tracción
D10717976	✓	-							(2) sólo algunos 05-07
MUSTANG									
						WBC50124	22.2 7/8"	Izq	
						WBC50125	22.2 7/8"	Der	
						WBC50130	20.6 13/16"	D/I	
						WBC50135	(1) 20.6 13/16"	Izq	(1) para tambor de 10"
						WBC50136	(1) 20.6 13/16"	Der	
						WBC50235	(2) 19.1 3/4"	D/I	(2) para tambor de 9"
						WBC50135	(1) 20.6 13/16"	Izq	(1) para tambor de 10"
						WBC50136	(1) 20.6 13/16"	Der	
						WBC50235	(2) 19.1 3/4"	D/I	(2) para tambor de 9"
						WBC50235	19.1 3/4"	D/I	



			EJE DELANTERO						  	
			PASTILLA	SM	CM	ROTOR	TIPO	CILINDRO MAESTRO		
FORD										
MUSTANG cont.										
Coupé	4.0L	07-08	D10817986	✓	—			BMC10311	27.0	1 1/16"
		09-10	D10817986	✓	—					
	3.7L	2011								
		12-14				BFR129710	Vent			
GT	5.0L	94-95								
		96-98								
	4.6L	99-04	D80476750	✓	—					
		05-08	D10817986	✓	—	BFR129710	Vent	BMC10311	27.0	1 1/16"
		2009	D10817986	✓	—	BFR129710	Vent			
		2010	D10817986	✓	—	BFR129710	Vent			
	4.6L 5.0L	11-14								
Shelby GT	5.4L	08-11						BMC10311	27.0	1 1/16"
		2012								
MYSTIQUE										
		95-96				BFR122010	Vent			
		97-98				BFR122010	Vent	BMC10201 ⁽¹⁾	25.4	1"
		99-00						BMC10201 ⁽¹⁾	25.4	1"
RANGER										
		95-97	D65275320	✓	✓	BFR124410	Vent	BMC10159 ⁽¹⁾	27.0	1 1/16"
						BFR124420 ⁽³⁾	Vent	BMC10160 ⁽²⁾	27.0	1 1/16"
		98-00	D65275320	✓	✓	BFR124610	Vent	BMC10190 ⁽¹⁾	27.0	1 1/16"
						BFR124620 ⁽³⁾	Vent			
	Tambor 10"	01-02	D65275320	✓	✓	BFR124610	Vent	BMC10191 ⁽¹⁾	27.0	1 1/16"
						Tambor 9"	BFR124620 ⁽³⁾	Vent	BMC10189 ⁽²⁾	27.0
	Tambor 10"	03-05	D83377060	✓	✓	BFR124610	Vent	BMC10191 ⁽¹⁾	27.0	1 1/16"
						Tambor 9"	BFR124620 ⁽³⁾	Vent	BMC10189 ⁽²⁾	27.0
	Tambor 10"	06-07	D83377060	✓	✓	BFR124610	Vent	BMC10189 ⁽¹⁾	27.0	1 1/16"
						Tambor 9"	BFR124620 ⁽²⁾	Vent	BMC10521	27.0
	Tambor 10"	08-09	D83377060	✓	✓	BFR124610	Vent	BMC10521	27.0	1 1/16"
						Tambor 9"	BFR124620 ⁽²⁾	Vent		

		EJE TRASERO							
PASTILLA / ZAPATA			TIPO		MEDIDA mm - in		I / D		
FORD									
MUSTANG cont.									
D10827987	✓	—	BRR124110	Vent					
D10827987	✓	—	BRR124110	Vent					
			BRR124110	Vent					
			BRR124110	Vent					
D62775040	✓	—	BRR120510	Vent					
D62775040	✓	—	BRR120510	Vent					
D62775040	✓	—	BRR120510	Vent					
D10827987	✓	—	BRR124110	Vent					
D10827987	✓	—	BRR124110	Vent					
D10827987	✓	—	BRR124110	Vent					
			BRR124110	Vent					
D10827987	✓	—	BRR124110	Vent					
			BRR124110	Vent					
MYSTIQUE									
S69614790					WBC50286	22.2	7/8"	D/I	
								(1) sin ABS	
								(1) sin ABS	
RANGER									
S70520890 (1)					WBC50138 (1)	19.1	3/4"	D/I (1) Tambor de 10" (2) Tambor de 9"	
S70421800 (2)					WBC50240 (2)	19.1	3/4"	D/I (3) incluye baleros cónicos	
S70520890 (1)			BRD122710 (1)		WBC50145 (1)	20.6	13/16"	D/I (1) Tambor de 10" (2) Tambor de 9"	
S70421800 (2)								D/I (3) incluye baleros cónicos	
S70520890			BRD122710		WBC50263	19.1	3/4"	D/I (1) con control de velocidad y accionamiento electrónico	
S70421800					WBC50190	19.1	3/4"	D/I (2) con control de velocidad (3) incluye baleros cónicos	
S70520890			BRD122710		WBC50145	20.6	13/16"	D/I (1) con control de velocidad y accionamiento electrónico	
S70421800					WBC50235	19.1	3/4"	D/I (2) con control de velocidad (3) incluye baleros cónicos	
S70520890			BRD122710		WBC50145	20.6	13/16"	D/I (1) con control de velocidad (2) incluye baleros cónicos	
S70421800					WBC50235	19.1	3/4"	D/I	
S70520890			BRD122710		WBC50145	20.6	13/16"	D/I (2) incluye baleros cónicos	
S70421800					WBC50235	19.1	3/4"	D/I	



		 2012... 2013... 2014...	EJE DELANTERO						 MEDIDA mm - in	
			 PASTILLA			 ROTOR	TIPO	CILINDRO MAESTRO		
FORD										
RANGER cont.										
		05-12	D65275320	✓	✓	BFR124610	Vent	BMC10535	27.0 1 1/16"	
						BFR124620 ⁽¹⁾	Vent			
		13->	D16768905	✓	✓	BFR220210	Vent			
SABLE										
		1994	D60174790	✓	—	BFR122210	Vent	BMC10490	25.4 1"	
		95-96	D60174790	✓	—	BFR122210	Vent			
		97-99	D60174790	✓	—	BFR122210	Vent	BMC10181	25.4 1"	
		2000	D60174790	✓	—	BFR122210	Vent	BMC10181 ⁽¹⁾	25.4 1"	
		01-04						BMC10181 ⁽¹⁾	25.4 1"	
TAURUS										
Guayin		89-93								
THUNDERBIRD										
		85-86						BMC10469 ⁽¹⁾	21.0 53/64"	
		1987						BMC10481	21.0 & 30.2	
		1988						BMC10481	21.0 & 30.2	
		1989				BFR122210	Vent			
		90-92				BFR122210	Vent	BMC10490	25.4 1"	
		93-96				BFR122210	Vent	BMC10490 ⁽¹⁾	25.4 1"	
S/C		93-94				BFR122210	Vent	BMC10490 ⁽¹⁾	25.4 1"	
TOPAZ										
		84-94	D2577106A	✓	—	BFR120110	Vent	BMC10463	19.7 & 28.6	
TRANSIT										
	FWD	07-13	D15288736N	✓	✓	BFR221810	Vent	BMC10354 ⁽¹⁾	25.4 1"	
	RWD		D15288736 ⁽²⁾	✓	✓	BFR220710	Vent			
	FWD	2014	CMD17749004	—	✓	BFR221810	Vent	BMC10354 ⁽¹⁾	25.4 1"	
	RWD		CMD17879014 ⁽²⁾	—	✓	BFR220710	Vent			
	DRW					BFR127310 ⁽³⁾	Vent			
		15-17	CMD17749004	—	✓	BFR127310 ⁽²⁾	Vent	BMC10560 ⁽¹⁾	28.5 1 1/8"	
			CMD17879014	—	✓	BFR129010 ⁽³⁾	Vent			
		18->	CMD17749004	—	✓	BFR127310 ⁽²⁾	Vent	BMC10560 ⁽¹⁾	28.5 1 1/8"	
			CMD17879014	—	✓	BFR128110 ⁽³⁾	Vent			
WINDSTAR										
	4 discos	95-97	D60174790	✓	—	BFR122210	Vent	BMC10153 ⁽²⁾	27.0 1 1/16"	
	2 discos									

PASTILLA / ZAPATA				ROTOR / TAMBOR	TIPO	CILINDRO DE RUEDA	MEDIDA mm - in		I / D	
FORD										
RANGER cont.										
S10362210				BRD121510		WBC50301	20.6	13/16"	Izq	⁽¹⁾ incluye baleros cónicos
						WBC50300	20.6	13/16"	Der	
S10491709				BRD122210		WBC50333	23.8	15/16"	D/I	
SABLE										
										⁽¹⁾ sin control de tracción
										⁽¹⁾ sin control de tracción
TAURUS										
						WBC50249	25.4	1"	D/I	
THUNDERBIRD										
						WBC50235	⁽¹⁾ 19.1	3/4"	D/I	⁽¹⁾ tambor de 9"
						WBC50235	⁽¹⁾ 19.1	3/4"	D/I	⁽¹⁾ tambor de 9"
						WBC50270	25.4	1"	D/I	
						WBC50270	25.4	1"	D/I	
						WBC50270	25.4	1"	D/I	
						WBC50270	25.4	1"	D/I	⁽¹⁾ 4 puertos
										⁽¹⁾ 4 puertos
TOPAZ										
S50113500						WBC50242	22.2	7/8"	Izq	
						WBC50243	22.2	7/8"	Der	
TRANSIT										
D15028701N	✓	✓		BRR125810	Sol					⁽¹⁾ con depósito
D15028701	⁽²⁾ ✓	✓		BRR124410	Sol					⁽²⁾ con cable sensor
CMD17759005	-	✓		BRR125810	Sol					⁽¹⁾ con depósito, Europeas VIN WF0....
CMD17869013	⁽²⁾ -	✓		BRR124410	Sol					⁽²⁾ con cable sensor ⁽³⁾ con doble rodada
CMD17759005	-	✓								⁽¹⁾ Americanas ⁽²⁾ con doble rodada ⁽³⁾ rodada sencilla
CMD17869013	-	✓								⁽¹⁾ Americanas ⁽²⁾ con doble rodada ⁽³⁾ rodada sencilla
CMD17759005	-	✓								⁽¹⁾ Americanas ⁽²⁾ con doble rodada ⁽³⁾ rodada sencilla
CMD17869013	-	✓								⁽¹⁾ Americanas ⁽²⁾ con doble rodada ⁽³⁾ rodada sencilla
WINDSTAR										
D66475430	✓	-		BRR120910	Sol					⁽¹⁾ sin control de tracción
				S70114840	⁽³⁾					
S66514520	⁽²⁾					WBC50270	25.4	1"	D/I	⁽²⁾ zapatas de freno de estacionamiento









		 2012... 2013... 2014...	EJE DELANTERO						 MEDIDA mm - in	
			 PASTILLA			 ROTOR	TIPO	CILINDRO MAESTRO		
FORD										
WINDSTAR cont.										
	4 discos	1998	D60174790	✓	—	BFR122210	Vent			
	2 discos	99-03	D80376740	✓	—	BFR126710	Vent	BMC10226 ⁽¹⁾	25.4 1"	
	BMC10227 ⁽²⁾							25.4 1"		
GMC										
ACADIA / ACADIA DENALI										
		07-10	D11698410	✓	✓	BFR137210	Vent	BMC10388	27.0 1 1/16"	
		11-16	D11698410	✓	✓	BFR137210	Vent	BMC10388	27.0 1 1/16"	
		17-20	CMD18969124	—	✓					
CANYON										
		07-08	D10397943	✓	—	BFR135610	Vent	BMC10283	25.4 1"	
		09-12	D11698282	✓	✓	BFR138210	Vent	BMC10401	27.0 1 1/16"	
SIERRA										
Crew Cab / Regular Cab		07-08	D10927997	✓	✓	BFR137310	Vent	BMC10363 ⁽¹⁾	28.5 1 1/8"	
								BMC10327 ⁽²⁾	31.7 1 1/4"	
SLE / SLT		09-13	D13638472	✓	✓	BFR137310	Vent	BMC10396 ⁽¹⁾	28.5 1 1/8"	
								BMC10397 ⁽²⁾	31.7 1 1/4"	
Denali		14->	D13638472	✓	✓	BFR137310	Vent	BMC10567	33.3 1 5/16"	
								CMD19109139 ⁽¹⁾	—	✓
Denali		2008	D10927997	✓	✓	BFR137310	Vent	BMC10363 ⁽¹⁾	28.5 1 1/8"	
								BMC10327 ⁽²⁾	31.7 1 1/4"	
All Terrain		09-13	D13638472	✓	✓	BFR137310	Vent	BMC10397	31.7 1 1/4"	
								BMC10567	33.3 1 5/16"	
All Terrain		14->	D13638472	✓	✓	BFR137310	Vent	BMC10567	33.3 1 5/16"	
								CMD19109139 ⁽¹⁾	—	✓

		EJE TRASERO							
PASTILLA / ZAPATA			 ROTOR / TAMBOR	TIPO	 CILINDRO DE RUEDA	MEDIDA mm - in		I / D	
FORD									
WINDSTAR cont.									
D66475430	✓	—	BRR120910	Sol					
			S70114840 ⁽²⁾						
S66514520					WBC50270	25.4	1"	D/I	⁽²⁾ zapatas de freno de estacionamiento
D66475430	✓	—	BRR120910	Sol					⁽¹⁾ con control de tracción, sin control dinámico
			S70114840 ⁽³⁾						⁽²⁾ sin control de tracción ni control dinámico
									⁽³⁾ zapatas de freno de estacionamiento
GMC									
ACADIA / ACADIA DENALI									
D88377600	✓	✓	BRR134410	Vent					
D15077760	✓	✓	BRR134410	Vent					
CANYON									
S81515480			BRD133610		WBC50177	23.8	15/16"	D/I	
S95916430			BRD133610		WBC50199	23.8	15/16"	D/I	
SIERRA									
D11948312	✓	✓	BRR133410	Vent					⁽¹⁾ sin StabiliTrak®
			S78121960 ⁽³⁾						⁽²⁾ con StabiliTrak®
									⁽³⁾ zapatas de freno de estacionamiento
			BRD134010		WBC50198 ⁽²⁾	26.9	1 1/16"	D/I	⁽¹⁾ sin StabiliTrak®
					WBC50199 ⁽⁴⁾	23.8	15/16"	D/I	⁽²⁾ con StabiliTrak®
									⁽³⁾ 6400 lb PBV
									⁽⁴⁾ 7000 lb PBV
D11948312	✓	✓	BRR133410	Vent					SLT, hasta 2015
			S10511710						⁽¹⁾ zapatas de freno de estacionamiento
D11948312	✓	✓	BRR133410	Vent					⁽¹⁾ sin StabiliTrak®
			S78121960						⁽²⁾ con StabiliTrak®
									⁽³⁾ zapatas de freno de estacionamiento
D11948312	✓	✓	BRR133410	Vent					
			S78121960 ⁽¹⁾						⁽¹⁾ zapatas de freno de estacionamiento
D11948312	✓	✓	BRR133410	Vent					⁽¹⁾ caliper 6 pistones
			S10511710 ⁽²⁾						⁽²⁾ zapatas de freno de estacionamiento
D11948312	✓	✓	BRR133410	Vent					
			S10511710 ⁽¹⁾						⁽¹⁾ zapatas de freno de estacionamiento









		2012... 2013... 2014...	EJE DELANTERO						MEDIDA mm - in	
			PASTILLA	SM	CM	ROTOR	TIPO	CILINDRO MAESTRO		
GMC										
TERRAIN										
/ Denali		11-17	CMD17458971	-	✓	BFR138510	Vent			
		18->								
YUKON										
		07-08	D10927997	✓	✓	BFR137310	Vent	BMC10327	31.7	1 1/4"
		08-14	D13638472	✓	✓	BFR137310	Vent	BMC10397	31.7	1 1/4"
		15-20	D13638472	✓	✓	BFR137310	Vent	BMC10397	31.7	1 1/4"
			CMD19109139 ⁽¹⁾	-	✓					
HONDA										
ACCORD L4										
EX / EX-R		96-97	D46573450	✓	✓	BFR510110	Vent			
		98-02	D46575730	✓	✓	BFR510310	Vent	BMC10536	25.4	1"
		03-07	D91477950	✓	✓	BFR510410	Vent	BMC10537	15.8	5/8"
		08-09	D78776560	✓	-	BFR510410	Vent	BMC10373 ⁽¹⁾	20.6	13/16"
		2010	D78776560	✓	-	BFR510410	Vent	BMC10373 ⁽¹⁾	20.6	13/16"
		11-12	D15067656	✓	✓	BFR510710	Vent	BMC10373 ⁽¹⁾	20.6	13/16"
	1.5T	18->	D16548883	✓	✓	BFR512310	Vent			
EXL	2.4L	13-17	D16548883	✓	✓	BFR512310	Vent			
LX	2.4L	03-07	D91477950	✓	✓	BFR510410	Vent	BMC10537	15.8	5/8"
		08-10	D91477950	✓	✓	BFR510410	Vent	BMC10373	20.6	13/16"
		11-17	D91477950	✓	✓	BFR510410	Vent	BMC10373	20.6	13/16"
Sport		2015	CMD16978840	-	✓	BFR512310	Vent			
		16-17	CMD16978840	-	✓					
Sport Plus	1.5T	18->	CMD21159349	-	✓	BFR512910	Vent			
Touring	2.0T	18->	CMD21159349	-	✓	BFR512910	Vent			
ACCORD V6										
EX		98-02	D50373820	✓	✓	BFR510410	Vent			
		2003	D95978570	✓	-	BFR510410	Vent	BMC10264	20.6	13/16"
		2004	D78776560 ⁽¹⁾	✓	-	BFR510710 ⁽¹⁾	Vent	BMC10264	20.6	13/16"
			D95978570 ⁽²⁾	✓	-	BFR510410 ⁽²⁾	Vent			
		05-07	D78776560 ⁽¹⁾	✓	-	BFR510710 ⁽¹⁾	Vent			
			D95978570 ⁽²⁾	✓	-	BFR510410 ⁽²⁾	Vent			
		08-10	D78776560	✓	-	BFR510410	Vent	BMC10373	20.6	13/16"
		11-14	D15067656	✓	✓	BFR510710	Vent	BMC10373	20.6	13/16"



		 2012... 2013... 2014...		EJE DELANTERO						
				 PASTILLA			 ROTOR	TIPO	CILINDRO MAESTRO	MEDIDA mm - in
HONDA										
ACCORD V6 cont.										
EX-L	3.5L	13-17	D16548883	✓	✓	BFR512310	Vent			
EX-R		98-01	D50373820	✓	✓	BFR510410	Vent			
		2002	D50373820	✓	✓	BFR510410	Vent			
ACCORD CROSSTOUR										
EXL		2010	D10897994	✓	✓	BFR511110	Vent	BMC10448	22.2 7/8"	
	4WD	11-13	D15217994	✓	✓	BFR511110	Vent	BMC10448	22.2 7/8"	
BR-V										
		18->	D15067656	✓	✓					
CITY										
		10-13	D15538763	✓	✓	BFR511010	Vent	BMC10526 ⁽¹⁾	19.1 3/4"	
		14->	CMD13948502	-	✓	BFR512510	Vent			
CIVIC COUPÉ										
EX-R		97-00	D46575730	✓	✓	BFR510210				
EX		01-02	D46575730	✓	✓	BFR511010	Vent	BMC10271	22.2 7/8"	
		03-05	D46575730	✓	✓	BFR511010	Vent	BMC10271	22.2 7/8"	
		06-11	D46575730	✓	✓	BFR510910	Vent	BMC10335	19.1 3/4"	
		2012	D15788791	✓	✓	BFR512410	Vent			
		13-15	D15788791	✓	✓	BFR510410	Vent	BMC10587	20.6 13/16"	
Si		07-11	D82977020	✓	-	BFR510510	Vent			
		12-15	D91477950	✓	✓	BFR510510	Vent	BMC10587	20.6 13/16"	
Turbo	1.5T	16->	D91477950	✓	✓	BFR510410	Vent			
CIVIC SEDÁN										
EX		01-02	D46575730	✓	✓	BFR511010	Vent	BMC10271	22.2 7/8"	
		03-05	D46575730	✓	✓	BFR511010	Vent	BMC10271	22.2 7/8"	
		06-11	D46575730	✓	✓	BFR510910	Vent	BMC10335	19.1 3/4"	
		2012	D15788791	✓	✓	BFR512410	Vent			
		13-15	D15788791	✓	✓	BFR510410	Vent	BMC10587	20.6 13/16"	
	2.0T	16->	D91477950	✓	✓	BFR510410	Vent			
EX-L		08-11	D46575730	✓	✓	BFR510910	Vent			
		2012	D15788791	✓	✓	BFR512410	Vent			
		13-15	D15788791	✓	✓	BFR510410	Vent	BMC10587	20.6 13/16"	
EX-R		97-00	D46575730	✓	✓	BFR510210		BMC10605	23.8 15/16"	
i-Style	2.0T	18->	D91477950	✓	✓	BFR510410	Vent			
LX		01-02	D46575730	✓	✓	BFR511010	Vent	BMC10253	20.6 13/16"	







		EJE TRASERO							
PASTILLA / ZAPATA			 ROTOR / TAMBOR	TIPO	 CILINDRO DE RUEDA	MEDIDA mm - in		I / D	
HONDA									
ACCORD V6 cont.									
D14518447	✓	✓	BRR511710	Sol					
D53774180	✓	✓	BRR510310	Sol					
D53674180	✓	✓	BRR510310	Sol					
ACCORD CROSSTOUR									
D10867418	✓	✓							
D10867418	✓	✓							
BR-V									
CITY									
D56474430	✓	✓	BRR511610	Sol					(1) T/M
S91316180			BRD510610						
CIVIC COUPÉ									
S57613640			BRD510110		WBC50265	19.1	3/4"	lzq	
					WBC50264	19.1	3/4"	Der	
S57613640			BRD510510		WBC50169	19.1	3/4"	Der	
					WBC50170	19.1	3/4"	lzq	
S57613640			BRD510510		WBC50178	19.1	3/4"	Der	
					WBC50179	19.1	3/4"	lzq	
D53774180	✓	✓	BRR511010	Sol					
D53774180	✓	✓	BRR511010	Sol					
D53774180	✓	✓	BRR511010	Sol					
D53774180	✓	✓	BRR511010	Sol					
D53774180	✓	✓	BRR511010	Sol					
D53774180	✓	✓	BRR511010	Sol					
CMD18789106	-	✓	BRR512810	Sol					
CIVIC SEDÁN									
S57613640			BRD510510		WBC50169	19.1	3/4"	Der	
					WBC50170	19.1	3/4"	lzq	
S57613640			BRD510510		WBC50178	19.1	3/4"	Der	
					WBC50179	19.1	3/4"	lzq	
D53774180	✓	✓	BRR511010	Sol					
D53774180	✓	✓	BRR511010	Sol					
D53774180	✓	✓	BRR511010	Sol					
CMD18789106	-	✓	BRR512810	Sol					
D53774180	✓	✓	BRR511010	Sol					
D53774180	✓	✓	BRR511010	Sol					
D53774180	✓	✓	BRR511010	Sol					
S57613640			BRD510110		WBC50265	19.1	3/4"	lzq	
					WBC50264	19.1	3/4"	Der	
CMD18789106	-	✓	BRR512810	Sol					
S57613640			BRD510510		WBC50169	19.1	3/4"	Der	
					WBC50170	19.1	3/4"	lzq	



		 2012... 2013... 2014...		EJE DELANTERO						
				 PASTILLA			 ROTOR	TIPO	CILINDRO MAESTRO	MEDIDA mm - in
HONDA										
CIVIC SEDÁN cont.										
LX		03-05	D46575730	✓	✓	BFR511010	Vent	BMC10271	22.2	7/8"
		06-11	D46575730	✓	✓	BFR510910	Vent	BMC10335	19.1	3/4"
		2012	D15788791	✓	✓	BFR512410	Vent			
		2013	D15788791	✓	✓	BFR512410	Vent	BMC10587	20.6	13/16"
		14-15	D15788791	✓	✓	BFR510410	Vent	BMC10587	20.6	13/16"
Si		07-10	D82977020	✓	—	BFR510510	Vent			
Sir		99-00	D46575730	✓	✓	BFR510210	Vent			
Touring / Turbo / Turbo Plus	1.5T	16->	D91477950	✓	✓	BFR510410	Vent			
Hybrid IMA		06-08				BFR510910	Vent			
		06-11				BFR510910	Vent			
		12-13				BFR510910	Vent			
CR-V										
		02-04	D91477950	✓	✓	BFR510610	Vent	BMC10246 ⁽¹⁾	23.8	15/16"
								BMC10522 ⁽²⁾	23.8	15/16"
		05-06	D91477950	✓	✓	BFR510510	Vent	BMC10332	25.4	1"
	FWD	07-11	D10897994	✓	✓	BFR511110	Vent	BMC10331	22.2	7/8"
		2012	D91477950 ⁽¹⁾	✓	✓	BFR511910 ⁽¹⁾	Vent	BMC10610	22.2	7/8"
			D15217994 ⁽²⁾	✓	✓	BFR511110 ⁽²⁾	Vent			
		AWD	13-16	D15217994	✓	✓	BFR511910	Vent	BMC10610	22.2
BFR511110	Vent									
		17->	CMD20368840	—	✓	BFR512910	Vent			
Touring		20->	D15217994	✓	✓					
CR-Z										
		13-15	CMD13948502	—	✓	BFR510910	Vent			
FIT										
		06-08	D12008320	✓	✓	BFR510810	Vent	BMC10333	22.2	7/8"
		09-14	D15538763	✓	✓	BFR511010	Vent	BMC10423	19.1	3/4"
		15-20	CMD13948502	—	✓	BFR512710	Vent			
HR-V										
		16->	D16548883	✓	✓	BFR512310	Vent			
INSIGHT										
		19->								
ODYSSEY										
		2000	D79376630	✓	✓	BFR510710	Vent	BMC10218 ⁽¹⁾	27.0	1 1/16"
								BMC10219 ⁽²⁾	27.0	1 1/16"
		2001	D79376630	✓	✓	BFR510710	Vent	BMC10219	27.0	1 1/16"
		02-04	D79376630	✓	✓	BFR510710	Vent	BMC10219	27.0	1 1/16"

PASTILLA / ZAPATA		SM CM		ROTOR / TAMBOR	TIPO	CILINDRO DE RUEDA	MEDIDA mm - in		I / D	i
HONDA										
CIVIC SEDÁN cont.										
S57613640				BRD510510		WBC50178	19.1	3/4"	Der	
						WBC50179	19.1	3/4"	Izq	
S91316180				BRD510210		WBC50188	19.1	3/4"	D/I	
S91316180				BRD510210		WBC50188	19.1	3/4"	D/I	
						WBC50344	20.6	13/16"	D/I	
S91316180				BRD510210		WBC50188	19.1	3/4"	D/I	
						WBC50344	20.6	13/16"	D/I	
S91316180				BRD510210		WBC50188	19.1	3/4"	D/I	
						WBC50344	20.6	13/16"	D/I	
D53774180	✓	✓		BRR511010	Sol					
D56474430	✓	✓								
CMD18789106	—	✓		BRR512810	Sol					
D53774180	✓	✓		BRR511010	Sol					
CR-V										
D53674180	✓	✓		BRR510510	Sol					(1) EX 4WD (2) LX
D10867418	✓	✓		BRR511110	Sol					
D10867418	✓	✓		BRR511110	Sol					
D10867418	✓	✓		BRR511110	Sol					(1) EX y EXL (2) LX
D10867418	✓	✓		BRR511110	Sol					
CMD20379268	—	✓		BRR512510	Sol					
CR-Z										
D53774180	✓	✓								
FIT										
S75515190						WBC50201	17.4	11/16"	Der	
						WBC50200	17.4	11/16"	Izq	
D56474430	✓	✓								
S91316180				BRD510610						
HR-V										
CMD18419069	—	✓		BRR511710	Sol					
INSIGHT										
CMD18789106	—	✓		BRR512810	Sol					
ODYSSEY										
S74415120						WBC50151	22.2	7/8"	Izq	(1) LX sin ABS
						WBC50150	22.2	7/8"	Der	(2) EX sin ABS
S74415120						WBC50151	22.2	7/8"	Izq	
						WBC50150	22.2	7/8"	Der	
D86577400	✓	✓								



		 2012... 2013... 2014...		EJE DELANTERO						
				 PASTILLA			 ROTOR	TIPO	CILINDRO MAESTRO	MEDIDA mm - in
HONDA										
ODYSSEY cont.										
		05-10	D10897994	✓	✓	BFR511210	Vent	BMC10336	22.2	7/8"
		11-14	D15217994	✓	✓	BFR512010	Vent	BMC10531	22.2	7/8"
		15-17	D15217994	✓	✓	BFR512610	Vent	BMC10531	22.2	7/8"
		18->	CMD20899324	—	✓	BFR512610	Vent			
PILOT										
		2003	D94378440	✓	—	BFR510710	Vent	BMC10218	27.0	1 1/16"
		2004	D94378440	✓	—	BFR510710	Vent	BMC10218	27.0	1 1/16"
		2005	D94378440	✓	—	BFR510710	Vent	BMC10218 ⁽¹⁾	27.0	1 1/16"
								BMC10339 ⁽²⁾	27.0	1 1/16"
		06-08	D94378440	✓	—	BFR510710	Vent	BMC10339	27.0	1 1/16"
		09-11	D13788396	✓	✓	BFR511410	Vent	BMC10372	22.2	7/8"
		12-15	D13788396	✓	✓	BFR511410	Vent	BMC10372	22.2	7/8"
		16->	CMD17238396	—	✓	BFR512610	Vent			
RIDGELINE										
		07-08	D11028208	✓	✓	BFR511310	Vent	BMC10339	27.0	1 1/16"
		09-11	D11028208	✓	✓	BFR511310	Vent	BMC10421	25.4	1"
		12-14	CMD15848208	—	✓	BFR511310	Vent	BMC10421	25.4	1"
HUMMER										
H2 / SUT										
		05-07	D78476520	✓	✓	BFR136210	Vent	BMC10216	37.0	
		08-09	D78476520	✓	✓	BFR136210	Vent			
H3 / T / ALPHA										
		06-10	D11198225	✓	✓					
HYUNDAI										
ACCENT										
		18->	D15938806	✓	✓	BFR500910	Vent			
CRETA										
		17-20	CMD18159049	—	✓	BFR501610	Vent			
ELANTRA										
		15-16	CMD15958810	—	✓	BFR500310	Vent			
		17->	CMD19129143	—	✓	BFR500310	Vent			
GRAND i10										
		15-20	CMD00012160 ⁽¹⁾	—	✓	BFR500110	Vent			
IONIQ										
		18->	CMD19129143	—	✓					
iX 35										
		2015	CMD18558614	—	✓					
SANTA FE / SPORT										
	2.0T	17->	CMD18159049	—	✓	BFR501110	Vent			
	3.3L	18-19				BFR501110	Vent			

PASTILLA / ZAPATA		EJE TRASERO		ROTOR / TAMBOR		TIPO	CILINDRO DE RUEDA	MEDIDA mm - in	I / D	i
SM	CM									
HONDA										
ODYSSEY cont.										
D10887993	✓	✓	BRR511210	Sol						
D12818397	✓	✓	BRR510910	Sol						
D12818397	✓	✓	BRR510910	Sol						
PILOT										
D86577400	✓	✓	BRR510610	Sol						
D79376630	✓	✓	BRR510610	Sol						
D86577400	✓	✓	BRR510610	Sol						(1) puertos de 10 x 1 mm (2) puertos de 14 x 1.5 mm
D86577400	✓	✓	BRR510610	Sol						
D12818397	✓	✓	BRR510910	Sol						
D15858397	✓	✓	BRR510910	Sol						
CMD17248397	—	✓								
RIDGELINE										
D11038209	✓	✓	BRR511310	Sol						
D11038209	✓	✓	BRR511310	Sol						
D11038209	✓	✓	BRR511310	Sol						
HUMMER										
H2 / SUT										
D78576530	✓	✓								(1) zapatas de freno de estacionamiento
			S77121920 (1)							
D78576530	✓	✓								
H3 / T / ALPHA										
D11208226	✓	—								
HYUNDAI										
ACCENT										
CMD18128428	—	✓	BRR113510	Sol						
CRETA										
S11011746			BRD500110							
ELANTRA										
D15448428	✓	✓	BRR500310	Sol						
CMD18128428	—	✓	BRR500310	Sol						
GRAND i10										
S10211616			BRD111110		WBC50345	17.8	0.0	D/I	(1) FMSI 9159-D1935	
IONIQ										
CMD18128428	—	✓								
iX 35										
D15448428	✓	✓								
SANTA FE / SPORT										
CMD18169051	—	✓	BRR501010	Sol						
CMD18169051	—	✓	BRR501010	Sol						



		2012... 2013... 2014...	EJE DELANTERO						MEDIDA mm - in
			PASTILLA	SM	CM	ROTOR	TIPO	CILINDRO MAESTRO	
HYUNDAI									
SONATA									
Premium / Limited	2.4L	15-16	CMD18558614	-	✓	BFR500510	Vent		
		17-18							
GLS	2.4L	15-18				BFR500510	Vent		
Sport	2.0T	15-18	CMD18558614	-	✓				
STAREX									
		18->	D15668775	✓	-	BFR110610	Vent		
TUCSON									
		16->	CMD18479075	-	✓	BFR500510	Vent		
INFINITI									
FX35									
		2012							
FX37									
		2013							
G37									
		12-13							
I30									
		98-99	D65373180	✓	-				
		00-01	D43073180	✓	✓				
I35									
		02-03	D43073180	✓	✓	BFR522110	Vent		
JX35									
		2013	CMD16498877	-	✓	BFR522410	Vent		
M37									
		12-13				BFR522410	Vent		
M56									
		12-13				BFR522410	Vent		
Q45									
		97-98	D69175660	✓	-				
		99-01	D85575660	✓	✓				
		02-06	D88877660	✓	-	BFR524110	Vent		
Q50									
Sedán		15-18	CMD17368906	-	✓	BFR525510	Vent		
Q70									
Sedán	V6	14-19				BFR522410	Vent		
QX50									
		19->	CMD17368906	-	✓				
QX56									
		12-13	D15098403	✓	✓				
QX60									
		14-18	CMD16498877	-	✓	BFR525510	Vent		





EJE TRASERO								i
PASTILLA / ZAPATA	SM	CM	ROTOR / TAMBOR	TIPO	CILINDRO DE RUEDA	MEDIDA mm - in	I / D	
HYUNDAI								
SONATA								
D15448428	✓	✓						Freno de estacionamiento eléctrico
D15448428	✓	✓						Freno de estacionamiento eléctrico
CMD18569036	—	✓						Freno de estacionamiento tipo pie
CMD18569036	—	✓						
STAREX								
TUCSON								
CMD18488428	—	✓	BRR501410	Sol				
INFINITI								
FX35								
D90577840	✓	✓	BRR521310	Vent				
FX37								
D90577840	✓	✓	BRR521310	Vent				
G37								
D90577840	✓	✓						
I30								
D54074210	✓	—						
D54074210	✓	—						
I35								
D90077770	✓	—						
JX35								
D14158405	✓	✓	BRR521310	Vent				
M37								
D90577840	✓	✓	BRR521310	Vent				
M56								
D90577840	✓	✓	BRR521310	Vent				
Q45								
Q50								
D90577840	✓	✓	BRR521310	Vent				
Q70								
D90577840	✓	✓	BRR521310	Vent				
QX50								
QX56								
QX60								
D14158405	✓	✓	BRR521310	Vent				



		2012... 2013... 2014...	EJE DELANTERO					TIPO	CILINDRO MAESTRO	MEDIDA mm - in
			PASTILLA	SM	CM	ROTOR				
INFINITI										
QX60 cont.										
		19->	CMD16498877	-	✓	BFR525510	Vent			
QX70										
		14->								
QX80										
		14->	D15098403	✓	✓					
JAGUAR										
S-TYPE										
		07-08								
X-TYPE										
		02-05	D91077890	✓	✓	BFR126910	Vent			
		05-08	D91077890	✓	✓	BFR126910	Vent			
XF										
		09-16								
R-SC		2009								
Premium Luxury		10-13								
Portfolio		13-16								
XJ										
Super V8		07-10								
Vanden Plas		05-09								
Premium Luxury	V6	11-15								
XJ-8										
		98-03								
		05-09								
XJ-8 VANDEN PLAS										
		98-99								
		06-09								
XJ-R										
		00-03								
		06-09								
XK-8										
		98-04								
XK R										
		07-09								
JEEP										
CHEROKEE										
	Tambor 9"	1994	D4777507A	✓	✓	BFR112710	Vent	BMC10135	(1)	25.4 1"
	Tambor 10"							BMC10491	(2)	23.8 15/16"





PASTILLA / ZAPATA				ROTOR / TAMBOR	TIPO	CILINDRO DE RUEDA	MEDIDA mm - in	I / D	
INFINITI									
QX60 cont.									
D90577840	✓	✓	BRR521310	Vent					
QX70									
D90577840	✓	✓	BRR521310	Vent					
QX80									
JAGUAR									
S-TYPE									
D10957957	✓	✓							
X-TYPE									
D91177900	✓	✓	BRR121510	Sol					
D10717976	✓	—	BRR121510	Sol					
XF									
D10957957	✓	✓							
D10957957	✓	✓							
D10957957	✓	✓							
D10957957	✓	✓							
XJ									
D10957957	✓	✓							
D10957957	✓	✓							
D10957957	✓	✓							
XJ-8									
D68875630	✓	✓							
D10957957	✓	✓							
XJ-8 VANDEN PLAS									
D68875630	✓	✓							
D68875630	✓	✓							
XJ-R									
D68875630	✓	✓							
D10957957	✓	✓							
XK-8									
D68875630	✓	✓							
XK R									
D10957957	✓	✓							
JEEP									
CHEROKEE									
S53821680			BRD112010		WBC50263 ⁽¹⁾	19.1	3/4"	D/I	⁽¹⁾ con ABS
					WBC50130 ⁽²⁾	20.6	13/16"	D/I	⁽²⁾ sin ABS
S67021740					WBC50124	22.2	7/8"	Izq	
					WBC50125	22.2	7/8"	Der	



				EJE DELANTERO						  					
				PASTILLA	SM	CM	ROTOR	TIPO	CILINDRO MAESTRO			MEDIDA mm - in			
JEEP															
CHEROKEE cont.															
	Tambor 9"	98-01	D4777507A	✓	✓	BFR112710	Vent	BMC10166	25.4	1"					
	Tambor 10"														
	L4	14-17	D16408867	✓	—	BFR116510	Vent								
	V6		CMD18438932	—	✓										
V6	18->	CMD18438932	—	✓	BFR116510	Vent									
Sport		1994 98-01	D4777507A	✓	✓	BFR112710	Vent	BMC10135	25.4	1"					
COMMANDER															
		06-10	D10807985	✓	✓	BFR111110	Vent	BMC10334	27.0	1 1/16"					
COMPASS															
		07-17	D86677410	✓	✓	BFR111410	Vent	BMC10357	20.6	13/16"					
		18->	CMD18119046	—	✓	BFR115410	Vent								
GRAND CHEROKEE															
	4 discos	93-94	D4777507A	✓	✓	BFR112710	Vent	BMC10135	25.4	1"					
	2 discos														
		94-98	D4777507A	✓	✓	BFR112710	Vent	BMC10166	25.4	1"					
			D79076600	✓	—						BFR114010	Vent	BMC10204	25.4	1"
			D94578460	✓	—						BFR114010	Vent	BMC10204	25.4	1"
			D10807985	✓	✓						BFR111110	Vent	BMC10334	27.0	1 1/16"
	V6	11-13	D14558655	✓	✓	BFR116610	Vent	BMC10546	27.0	1 1/16"					
	V8					BFR117010	Vent								
	V6	14-15	CMD16298856	—	✓	BFR116610	Vent	BMC10546	27.0	1 1/16"					
	V8					BFR117010	Vent								
	V6	16->	CMD16298856	—	✓	BFR116610	Vent								
	V8					BFR117010	Vent								
	SRT-8		2007	D11498259	✓	—			BMC10334	27.0	1 1/16"				
			08-10	D11498259	✓	—			BMC10334	27.0	1 1/16"				
		12-15						BMC10546	27.0	1 1/16"					
SRT		16->													
LIBERTY															
		02-03	D85677320	✓	✓	BFR114910	Vent	BMC10244	27.0	1 1/16"					







PASTILLA / ZAPATA		SM CM		ROTOR / TAMBOR		TIPO	CILINDRO DE RUEDA		MEDIDA mm - in		I / D	i
JEEP												
CHEROKEE cont.												
S53821680				BRD112010			WBC50130	20.6	13/16"	D/I		
S67021740							WBC50124	22.2	7/8"	Izq		
							WBC50125	22.2	7/8"	Der		
CMD17348958	-	✓		BRR113810	Sol							
CMD17348958	-	✓										
S53821680				BRD112010			WBC50263 ⁽¹⁾	19.1	3/4"	D/I	⁽¹⁾ con ABS	
							WBC50130 ⁽²⁾	20.6	13/16"	D/I	⁽²⁾ sin ABS	
COMMANDER												
D10877945	✓	✓		BRR112010	Sol							
COMPASS												
D10377940	✓	✓		BRR112210	Sol							
D86877430	✓	✓		BRR112410	Sol							
				BRR114310	Sol							
GRAND CHEROKEE												
D6257502A	✓	-		BRR110810	Sol							
				S70114840 ⁽¹⁾								
S67021740							WBC50124	22.2	7/8"	Izq		
							WBC50125	22.2	7/8"	Der	⁽¹⁾ zapatas de freno de estacionamiento	
D6667502A	✓	-		BRR110810	Sol							
				S70114840 ⁽¹⁾							⁽¹⁾ zapatas de freno de estacionamiento	
D79176610	✓	-		BRR111210	Sol							
D79176610	✓	-		BRR111210	Sol							
D10877945	✓	✓		BRR112010	Sol							
D10537958 ⁽¹⁾	✓	-									⁽¹⁾ opcional 2006	
D14988698	✓	✓		BRR112810	Sol							
				BRR113210	Vent							
D14988698	✓	✓		BRR112810	Sol							
				BRR113210	Vent							
D14988698	✓	✓		BRR112810	Sol							
				BRR113210	Vent							
D10537958	✓	-										
D10537958	✓	-										
D10537958	✓	-										Fenos Brembo 6 pistones delanteros, 4 pistones traseros
LIBERTY												
							WBC50158	20.6	13/16"	D/I		



			EJE DELANTERO						  	
			PASTILLA	SM	CM	ROTOR	TIPO	CILINDRO MAESTRO		
JEEP										
LIBERTY cont.										
		03-05	D85677320	✓	✓	BFR114910	Vent	BMC10244	27.0	1 1/16"
		06-07	D85677320	✓	✓	BFR114910	Vent	BMC10341	27.0	1 1/16"
		08-13	D12738389	✓	✓	BFR116710	Vent	BMC10377	27.0	1 1/16"
PATRIOT										
		07-17	D86677410	✓	✓	BFR111410	Vent	BMC10357	20.6	13/16"
RENEGADE										
		17->	CMD18119046	-	✓	BFR115410	Vent			
WRANGLER										
		92-95	D4777507A	✓	✓	BFR112710	Vent			
		97-00	D4777507A	✓	✓	BFR112710	Vent	BMC10184	25.4	1"
		01-02	D4777507A	✓	✓	BFR112710	Vent	BMC10184	25.4	1"
	4 discos	03-05	D4777507A	✓	✓	BFR116010	Vent	BMC10184	25.4	1"
	2 discos					BFR112710	Vent			
	4 discos	2006	D4777507A	✓	✓	BFR116010	Vent	BMC10184	25.4	1"
	2 discos									
		07-12	D12738389	✓	✓	BFR111710	Vent	BMC10358	25.4	1"
		13-18	D12738389	✓	✓	BFR111710 ⁽¹⁾	Vent	BMC10358 ⁽¹⁾	25.4	1"
						BMC10377 ⁽²⁾		27.0	1 1/16"	
		19->	D15898800	✓	✓					
KIA										
FORTE										
EX, LX		16-18	CMD15958810	-	✓	BFR500310	Vent			
SX								CMD17358960	-	✓
	2.0L	19->	CMD13978505	-	✓					
NIRO										
		17->	CMD19129143	-	✓					
OPTIMA										
		16->	CMD18558614	-	✓					
RIO										
		16-17	D15938806	✓	✓	BFR500910	Vent			
		08->	D15938806	✓	✓	BFR501710	Vent			
SELTOS										
		20->	CMD18159049	-	✓					







PASTILLA / ZAPATA				ROTOR / TAMBOR	TIPO	CILINDRO DE RUEDA	MEDIDA mm - in		I / D	
JEEP										
LIBERTY cont.										
D98178630	✓	✓		BRR110710	Sol					
D98178630	✓	✓		BRR110710	Sol					
D12748390	✓	✓		BRR113010	Sol					
PATRIOT										
D10377940	✓	✓		BRR112210	Sol					
D86877430 ⁽¹⁾	✓	✓								⁽¹⁾ alternativo 08-10
RENEGADE										
CMD18099044	—	✓		BRR114310	Sol					
WRANGLER										
S53821680				BRD112010		WBC50130	20.6	13/16"	D/I	
S53821680				BRD112010		WBC50130 ⁽¹⁾	20.6	13/16"	D/I	⁽¹⁾ sin ABS
						WBC50263 ⁽²⁾	19.1	3/4"	D/I	⁽²⁾ con ABS
				BRD112010		WBC50263	19.1	3/4"	D/I	
D96478630	✓	—		BRR110710	Sol					
				BRD112010		WBC50263	19.1	3/4"	D/I	
D96478630	✓	—		BRR110710	Sol					
D98178630	✓	✓								
				BRD112010		WBC50263	19.1	3/4"	D/I	
D12748390	✓	✓		BRR112310	Sol					
D12748390	✓	✓		BRR112310	Sol					⁽¹⁾ con frenos estandar ⁽²⁾ con frenos HD
KIA										
FORTE										
CMD15948428	—	✓		BRR500310	Sol					
NIRO										
CMD18128428	—	✓								
OPTIMA										
D15448428 ⁽¹⁾	✓	✓								⁽¹⁾ con freno de esacionamiento eléctrico
CMD18569036 ⁽²⁾	—	✓								⁽²⁾ con freno de estacionamiento manual
RIO										
D15448428	✓	✓		BRR113510	Sol					
D15448428	✓	✓		BRR113510	Sol					
SELTOS										



		 2012... 2013... 2014...		EJE DELANTERO						 PASTILLA			 ROTOR	TIPO	CILINDRO MAESTRO	MEDIDA mm - in
																
KIA																
SORENTO																
	2.4L	16->	CMD18159049	-	✓	BFR500710	Vent									
SOUL																
		16-19	CMD13978505	-	✓	BFR501510 ⁽¹⁾	Vent									
			CMD14478615	-	✓	BFR501610 ⁽²⁾	Vent									
SX	1.6T	17-19				BFR501610	Vent									
SPORTAGE																
	2.0L	2016	CMD18479075	-	✓	BFR500510	Vent									
SLX	FWD		CMD18558614	-	✓											
	2.0L AWD		CMD18479075	-	✓											
SX		17-19	CMD18479075	-	✓	BFR500510	Vent									
		17->	CMD18479075	-	✓	BFR500510	Vent									
LINCOLN																
AVIATOR																
		03-04	D95378520	✓	-									BMC10189 ⁽¹⁾	27.0 1 1/16"	
		2005	D95378520	✓	-											
BLACKWOOD																
		2003	D67975580	✓	✓	BFR124710	Vent							BFR124720 ⁽²⁾	Vent	
CONTINENTAL																
		18-20	CMD18189053		✓											
CORSAIR																
		20->	CMD23009536		✓											
MARK LT																
		06-08	D10837915	✓	✓	BFR120910 ⁽¹⁾	Vent	BMC10273						28.5	1 1/8"	
						BFR221510 ⁽²⁾	Vent									
		10-14	D14148528	✓	✓											
MKC																
	AWD	15-19	CMD17718896	-	✓			BMC10359						20.6	13/16"	
MKS																
		09-11	D15088715	✓	✓											
		2012	D15088715	✓	✓	BFR221710	Vent									
		13-14	D16118824	✓	✓											
MKX																
	FWD	2007	D12588377	✓	✓			BMC10393						22.2	7/8"	
	AWD	07-10	D12588377	✓	✓	BFR123110	Vent	BMC10393						22.2	7/8"	
		11-12	D12588377	✓	✓	BFR123110	Vent	BMC10393						22.2	7/8"	







		EJE TRASERO							
PASTILLA / ZAPATA			TIPO		MEDIDA mm - in	I / D			
KIA									
SORENTO									
D15448428	✓	✓							
SOUL									
CMD15948428	—	✓	BRR500310	Sol				(1) diámetro de 280.0 mm (2) diámetro de 300.0 mm	
SPORTAGE									
			BRR501410	Sol					
CMD18488428	—	✓							
CMD18488428	—	✓	BRR501410 (1)	Sol				(1) para 2.0L	
LINCOLN									
AVIATOR									
D95278510	✓	—						(1) sin control de tracción (2) zapatas de freno de estacionamiento	
			S79115330 (2)						
D95278510	✓	—						(1) zapatas de freno de estacionamiento	
			S79115330 (1)						
BLACKWOOD									
D87975840	✓	✓	BRR123010	Sol				(2) incluye baleros cónicos (1) zapatas de freno de estacionamiento	
			S75215170 (1)						
CONTINENTAL									
CMD18338893	—	✓							
CORSAIR									
MARK LT									
D10127916	✓	✓	BRR122210	Vent				(1) 4X2 (2) 4X4 (3) zapatas de freno de estacionamiento	
			S75215170 (3)						
D10127916	✓	✓	BRR122210	Vent				(1) zapatas de freno de estacionamiento	
			S75215170 (1)						
MKC									
CMD18338893	—	✓	BRR125710	Sol					
MKS									
D13778488	✓	✓	BRR123210	Sol					
D13778488	✓	✓	BRR123210	Sol					
D16128825	✓	✓							
MKX									
D12598378	✓	✓	BRR123410	Vent					
D12598378	✓	✓	BRR123410	Vent					
D13778488	✓	✓	BRR123210	Sol					



		 2012... 2013... 2014...	EJE DELANTERO							
			 PASTILLA			 ROTOR	TIPO	 CILINDRO MAESTRO	MEDIDA mm - in	
LINCOLN										
MKX cont.										
		13-15	D12588377	✓	✓	BFR123110	Vent	BMC10393	22.2	7/8"
		16-18	CMD18189053	—	✓					
MKZ										
		07-08	D11648277	✓	✓	BFR128810	Vent	BMC10359	20.6	13/16"
		2009	D11648277	✓	✓	BFR128810	Vent			
		10-12	D11648277	✓	✓	BFR128810	Vent	BMC10428	22.2	7/8"
		13-16	D16538882	✓	✓					
		17-20	D16538882	✓	✓					
			CMD18189053	—	✓					
NAUTILUS										
		19->	CMD18189053	—	✓					
NAVIGATOR										
		98-99	D70275760	✓	✓	BFR125110 ⁽³⁾	Vent	BMC10174 ⁽¹⁾	31.7	1 1/4"
						BFR124910 ⁽⁴⁾	Vent	BMC10104 ⁽²⁾	31.7	1 1/4"
		2000	D70275760	✓	✓	BFR125110 ⁽¹⁾	Vent	BMC10174	31.7	1 1/4"
		2001	D70275760	✓	✓	BFR125110 ⁽³⁾	Vent	BMC10174 ⁽¹⁾	31.7	1 1/4"
								BMC10173 ⁽²⁾	31.7	1 1/4"
		2002	D70275760	✓	✓	BFR125110 ⁽³⁾	Vent	BMC10260 ⁽¹⁾	28.5	1 1/8"
								BMC10261 ⁽²⁾	28.5	1 1/8"
		03-04	D93478370	✓	—	BFR128210 ⁽³⁾	Vent	BMC10260 ⁽¹⁾	28.5	1 1/8"
						BFR124910 ⁽⁴⁾	Vent	BMC10261 ⁽²⁾	28.5	1 1/8"
		05-06	D93478370	✓	—	BFR128210 ⁽¹⁾	Vent	BMC10261	28.5	1 1/8"
						BFR124910 ⁽²⁾	Vent			
		07-09	D12788394	✓	✓	BFR124310	Vent			
		10-11	D14148528	✓	✓	BFR124310	Vent	BMC10446	30.1	1 3/16"
		12-14	D14148528	✓	✓	BFR124310	Vent	BMC10544	30.1	1 3/16"
		15-17	D17708528	✓	—	BFR124310	Vent			
		18->	D14148528	✓	✓	BFR124310	Vent			
TOWN CAR										
		98-00	D74876170	✓	—			BMC10220 ⁽¹⁾	25.4	1"
		01-02	D74876170	✓	—					
ZEPHYR										
		2006	D11648277	✓	✓	BFR128810	Vent	BMC10359	20.6	13/16"







		EJE TRASERO						
PASTILLA / ZAPATA			TIPO		CILINDRO DE RUEDA	MEDIDA mm - in	I / D	
LINCOLN								
MKX cont.								
CMD17548970	-	✓	BRR123210	Sol				
CMD18338893	-	✓						
MKZ								
D11618272	✓	✓	BRR123110	Sol				
D11618272	✓	✓	BRR123110	Sol				
D11618272	✓	✓	BRR123110	Sol				
CMD18338893	-	✓	BRR125710	Sol				
CMD18338893	-	✓						
NAUTILUS								
CMD18338893	-	✓						
NAVIGATOR								
D71175840	✓	✓	BRR121110	Sol			(1) con control de velocidad (2) sin control de velocidad (3) 4X2 (4) 4X4	
			S75215170					
D87975840	✓	✓	BRR123010	Sol			(1) 4X2	
			S75215170					
D87975840	✓	✓	BRR123010	Sol			(1) hasta 23/05/2001 (2) de 23/05/2001 al 17/03/2002 (3) 4X2	
			S75215170					
D87975840	✓	✓	BRR123010	Sol			(1) desde 18/03/2002 sin Advance Trac (2) desde 18/03/2002 con Advance Trac (3) 4X2	
			S75215170					
D93578380	✓	-	BRR122010	Vent			(1) sin Advance Trac (2) con Advance Trac (3) 4X2 (4) 4X4	
D93578380	✓	-	BRR122010	Vent			(1) 4X2 (2) 4X4	
D12798395	✓	✓	BRR123510	Vent				
D12798395	✓	✓	BRR123510	Vent				
D12798395	✓	✓	BRR123510	Vent				
D12798395	✓	✓	BRR123510	Vent				
TOWN CAR								
							(1) con control de tracción	
ZEPHYR								
D11618272	✓	✓	BRR123110	Sol				



 		EJE DELANTERO							
		 PASTILLA  	 ROTOR	TIPO	CILINDRO MAESTRO	MEDIDA mm - in			
MAZDA									
2									
		12-16	D14548738	✓	✓	BFR580710	Vent		
		17-19	CMD18529081	—	✓	BFR580710	Vent		
3									
		06-13	D10447947	✓	✓	BFR580410	Vent	BMC10355	25.4 1"
						BFR580510	Vent		
	2.5L	14-16	CMD17288952	—	✓	BFR580910	Vent		
		17-18	CMD17288952	—	✓	BFR580910	Vent		
	2.0L	14-16	CMD17598987	—	✓	BFR581210	Vent		
		17-18	CMD17598987	—	✓	BFR581210	Vent		
		19->	CMD22189458	—	✓				
Speed 3		08-13							
5									
		06-10	D10447947	✓	✓	BFR580510	Vent	BMC10424	22.2 7/8"
		11-15	D10447947	✓	✓	BFR580510	Vent	BMC10424	22.2 7/8"
6									
		2006	D11928277	✓	—	BFR128810	Vent	BMC10359 ⁽¹⁾	20.6 13/16"
		2007	D11928277	✓	—	BFR128810	Vent	BMC10359	20.6 13/16"
		2008	D11648277	✓	✓	BFR128810	Vent	BMC10359	20.6 13/16"
		09-13	D11648277	✓	✓	BFR128810	Vent	BMC10416	22.2 7/8"
		14-15	CMD17118936	—	✓	BFR580810	Vent		
		16->	CMD17118936	—	✓	BFR580810	Vent		
CX-3									
		16->	CMD17288952	—	✓	BFR580910	Vent		
CX-30									
		20->	CMD17288952	—	✓				
CX-5									
		13-15	D16238836	✓	✓	BFR580810	Vent		
		16->	D16238836	✓	✓	BFR581010	Vent		
CX-7									
		07-12	D12588377	✓	✓	BFR580110	Vent	BMC10541	22.2 7/8"
CX-9									
		07-15	D12588377	✓	✓	BFR580210	Vent	BMC10418	22.2 7/8"
		16->	D12588377	✓	✓				
MX-5									
Grand Touring /		06-15							
MERCEDES BENZ									
A160									
		00-05	D12508368	✓	—				
A190									
		01-05	D12508368	✓	—				

PASTILLA / ZAPATA		ROTOR / TAMBOR		TIPO	CILINDRO DE RUEDA	MEDIDA mm - in		I / D
EJE TRASERO								
i								
MAZDA								
2								
S99114370					WBC50346	19.1	3/4"	D/I
S99114370					WBC50346	19.1	3/4"	D/I
3								
D10957957	✓	✓	BRR580610	Sol				
			BRR580510	Sol				
CMD17298953	—	✓	BRR580810	Sol				
CMD20429271	—	✓	BRR580810	Sol				
D16798908	✓	—	BRR580810	Sol				
CMD20429271	—	✓	BRR580810	Sol				
CMD22199459	—	✓	BRR580810	Sol				
D10957957	✓	✓	BRR580510	Sol				
5								
			BRR580410	Sol				
D10957957	✓	✓	BRR580410	Sol				
6								
D11618272	✓	✓	BRR123110	Sol				(1) con ABS
D11618272	✓	✓	BRR123110	Sol				
D11618272	✓	✓	BRR123110	Sol				
D11618272	✓	✓	BRR123110	Sol				
D16798908	✓	—						
CMD18749103	—	✓						
CX-3								
CMD16248837	—	✓	BRR580910	Sol				
CX-30								
CMD22199459	—	✓	BRR580810	Sol				
CX-5								
CMD16248837	—	✓	BRR580210	Sol				
CMD18469073	—	✓	BRR580210	Sol				
CX-7								
D12598378	✓	✓	BRR580310	Vent				
CX-9								
D12598378	✓	✓	BRR580110	Vent				
CMD19349157	—	✓						
MX-5								
			BRR123110	Sol				
MERCEDES BENZ								
A160								
A190								



	  2012... 2013... 2014...	EJE DELANTERO						MEDIDA mm - in
		 PASTILLA			 ROTOR	TIPO	CILINDRO MAESTRO	
MERCEDES BENZ								
C200								
	01-04	CMD71075830	-	✓				
C230								
	97-00	CMD71075830	-	✓				
C280								
	96-00	CMD71075830	-	✓				
CLK320								
	98-03	D85377300	✓	-				
CLK430								
	99-03	D85377300	✓	-				
E280								
	1999	D85377300	✓	-				
E300								
	10-11	D85377300	✓	-				
E320								
	97-04	D85377300	✓	-				
E420								
(W210)	97-98	D85377300	✓	-				
E430								
(W210)	99-02	D85377300	✓	-				
G500 L								
G500	02->							
Convertible	08-13							
G55 AMG								
	08-09							
ML320								
	98-03	CMD76076280	-	✓				
ML350								
	03-05	CMD76076280	-	✓				
	2012	CMD16298856	-	✓				
ML350 SPORT AMG								
	13-15	CMD16298856	-	✓				
ML430								
	98-99	CMD76076280	-	✓				
SLK200								
	03-04	CMD71075830	-	✓				
SLK230								
	97-04	CMD71075830	-	✓				
SLK320								
	01-04	CMD71075830	-	✓				
		D85377300	✓	-				

 		EJE TRASERO						
PASTILLA / ZAPATA	 	 ROTOR / TAMBOR	TIPO	 CILINDRO DE RUEDA	MEDIDA mm - in	I / D		
MERCEDES BENZ								
C200								
C230								
C280								
CLK320								
CLK430								
E280								
E300								
E320								
E420								
E430								
G500 L								
D92878290	✓	-	BRR340110	Sol				
D92878290	✓	-	BRR340110	Sol				
G55 AMG								
D92878290	✓	-						
ML320								
ML350								
ML350 SPORT AMG								
ML430								
SLK200								
SLK230								
SLK320								











			EJE DELANTERO				TIPO	CILINDRO MAESTRO	MEDIDA mm - in
			 PASTILLA			 ROTOR			
MERCEDES BENZ									
SLK32 AMG									
		2001	CMD71075830	-	✓				
			D85377300	✓	-				
SPRINTER VAN / WAGON / CHASIS									
316		04-06	D94978480	✓	-	BFR340110	Vent	BMC10324 ⁽¹⁾	25.4 1"
			D9497848A ⁽³⁾	✓	-			BMC10323 ⁽²⁾	23.8 15/16"
416		04-06	D95078490	✓	-	BFR340210	Vent	BMC10324 ⁽¹⁾	25.4 1"
			D9507849A ⁽³⁾	✓	-			BMC10323 ⁽²⁾	23.8 15/16"
315		07-11	D13168430	✓	-	BFR343910	Vent	BMC10328 ⁽¹⁾	27.0 1 1/16"
			D13168430S ⁽³⁾	✓	-			BMC10547 ⁽²⁾	27.0 1 1/16"
		12-14	D13168430	✓	-	BFR343910	Vent	BMC10547 ⁽¹⁾	27.0 1 1/16"
			D13168430A ⁽³⁾	✓	-			BMC10328 ⁽²⁾	27.0 1 1/16"
		15-18	D16938430S ⁽¹⁾	✓	-	BFR343910	Vent		
316		19->	D16998383S ⁽¹⁾	✓	-	BFR343910	Vent		
415 / 515		07-11	D12688383	✓	-	BFR343910	Vent	BMC10328 ⁽¹⁾	27.0 1 1/16"
			D12688383S ⁽³⁾	✓	-			BMC10547 ⁽²⁾	27.0 1 1/16"
		12-14	D12688383	✓	-	BFR343910	Vent	BMC10547 ⁽¹⁾	27.0 1 1/16"
			D12688383A ⁽³⁾	✓	-			BMC10328 ⁽²⁾	27.0 1 1/16"
		15-18	D16998383S ⁽¹⁾	✓	-	BFR343910	Vent		
416 / 516		19->	D16998383S ⁽¹⁾	✓	-	BFR343910	Vent		
311		12-18	D16938430S ⁽¹⁾	✓	-	BFR345710	Vent		
		19->	D16938430S ⁽¹⁾	✓	-	BFR345710	Vent		
VIANO									
		13-15	D13168430	✓	-				
VITO									
		2009	D13168430	✓	-				





PASTILLA / ZAPATA				ROTOR / TAMBOR	TIPO	CILINDRO DE RUEDA	MEDIDA mm - in	I / D	
EJE TRASERO									
MERCEDES BENZ									
SLK32 AMG									
SPRINTER VAN / WAGON / CHASIS									
D94978480	✓	—	BRR340110	Sol					
D9497848A (3)	✓	—							(1) pasajeros
D92878290	✓	—							(2) carga
D9287829A (3)	✓	—							(3) con 2 sensores
D95178500	✓	—	BRR340210	Vent					(1) pasajeros
D9517850A (3)	✓	—							(2) carga
									(3) con 2 sensores
D13178431	✓	—	BRR343010	Sol					(1) sistema Bosch
D13178431S (3)	✓	—							(2) sistema TRW
			S93815950 (4)						(3) con 2 sensores "L"
									(4) zapatas de freno de estacionamiento
D13178431	✓	—	BRR343010	Sol					(1) sistema TRW 12-14
D13178431A (3)	✓	—							(2) sistema Bosch solo 2014
			S93815950 (4)						(3) con 2 sensores planos
									(4) zapatas de freno de estacionamiento
D13178431	✓	—	BRR343010	Sol					(1) con 2 sensores "L"
D13178431S (1)	✓	—							(2) zapatas de freno de estacionamiento
			S93815950 (2)						
D13178431	✓	—	BRR343010	Sol					(1) con 2 sensores "L"
D13178431S (1)	✓	—							
D13188432	✓	—	BRR342910	Vent					(1) sistema Bosch
D13188432S (3)	✓	—							(2) sistema TRW
									(3) con 2 sensores "L"
D13188432	✓	—	BRR342910	Vent					(1) sistema TRW 12-14
D13188432A (3)	✓	—							(2) sistema Bosch solo 2014
									(3) con 2 sensores planos
D13188432	✓	—	BRR342910	Vent					(1) con 2 sensores "L"
D13188432A (2)	✓	—							(2) con 2 sensores planos
D22369475			BRR342910	Vent					(1) con 2 sensores "L"
D13178431	✓	—	BRR343010	Sol					(1) con 2 sensores "L"
D13178431S (1)	✓	—							(2) zapatas de freno de estacionamiento
			S93815950 (2)						
			BRR343010	Sol					(1) con 2 sensores "L"
			S93815950 (2)						(2) zapatas de freno de estacionamiento
VIANO									
VITO									



		 2012... 2013... 2014...	EJE DELANTERO								
			 PASTILLA			 ROTOR	TIPO	CILINDRO MAESTRO	MEDIDA mm - in		
MERCURY											
MARINER											
	4X4	05-06	D10477950	✓	✓	BFR120210	Vent	BMC10301	27.0	1 1/16"	
		2007	D84377190	✓	✓	BFR120210	Vent	BMC10301	27.0	1 1/16"	
	4X2	2008	D10477950	✓	✓	BFR120210	Vent	BMC10302	25.4	1"	
	2008		D10477950	✓	✓	BFR120210	Vent				
	4X4	2009	D10477950	✓	✓	BFR120210	Vent	BMC10414 ⁽¹⁾	27.0	1 1/16"	
	2009		D10477950	✓	✓	BFR120210	Vent	BMC10415 ⁽²⁾	27.0	1 1/16"	
	4X2	10-11	D10477950	✓	✓	BFR120210	Vent	BMC10414 ⁽¹⁾	27.0	1 1/16"	
10-11	D10477950		✓	✓	BFR120210	Vent	BMC10415 ⁽²⁾	27.0	1 1/16"		
MILAN											
		07-08	D11648277	✓	✓	BFR128810	Vent	BMC10359	20.6	13/16"	
MONTEGO											
		05-07	D10707975	✓	—			BMC10312 ⁽¹⁾	25.4	1"	
								BMC10303 ⁽²⁾	25.4	1"	
MINI											
COOPER											
		02-05	D93978410	✓	✓	BFR320810	Vent				
		2006	D93978410	✓	✓	BFR320810	Vent				
		07-08	D13088423	✓	✓	BFR320510	Vent				
		09-13	D13088423	✓	✓	BFR320510	Vent				
		2014	D12048324			BFR320610	Vent				
		14->	D13088423	✓	✓						
Convertible		09->	D13088423	✓	✓	BFR320510	Vent				
Clubman		18->				BFR320510	Vent				
COOPER S											
		02-03	D93978410	✓	✓	BFR320810	Vent				
		04-06	D93978410	✓	✓	BFR320810	Vent				
		2007	D93978410	✓	✓	BFR320810	Vent				
			D12048324	✓	✓	BFR320610	Vent				
		2008	D12048324	✓	✓	BFR320610	Vent				
		09-14	D12048324	✓	✓	BFR320610	Vent				
Clubman		08-14	D12048324	✓	✓	BFR320610	Vent				
Convertible		2005	D93978410	✓	✓	BFR320810	Vent				
		2006	D93978410	✓	✓	BFR320810	Vent				
		07-08	D93978410	✓	✓						
		1.6L	09-10	D12048324	✓	✓	BFR320610	Vent			
			2011	D13088423	✓	✓	BFR320610	Vent			
			12-15	D12048324	✓	✓	BFR320610	Vent			
2016	D12048324		✓	✓	BFR320610	Vent					
Countryman	1.6L	11-15	D12048324	✓	✓						









PASTILLA / ZAPATA		SM CM		ROTOR / TAMBOR	TIPO	CILINDRO DE RUEDA	MEDIDA mm - in		I / D	i
MERCURY										
MARINER										
D10557961	✓	—								
D10557961	✓	—								
D11098214	✓	✓								
S76015240				BRD124210		WBC50155	23.8	15/16"	D/I	
S93616290				BRD120110		WBC50202	23.8	15/16"	D/I	
D10557961	✓	—								⁽¹⁾ T/A
D11098214	✓	✓								
S93616290				BRD120110		WBC50202	23.8	15/16"	D/I	⁽²⁾ T/M
S93616290				BRD120110		WBC50202	23.8	15/16"	D/I	⁽¹⁾ T/A ⁽²⁾ T/M
MILAN										
D11618272	✓	✓		BRR123110	Sol					
MONTEGO										
D10717976	✓	—		BRR123210	Sol					⁽¹⁾ sin control de tracción ⁽²⁾ con control de tracción
MINI										
COOPER										
D94078420	✓	✓		BRR320210	Sol					
				BRR320210	Sol					
D13098424	✓	✓		BRR320310	Sol					
D13098424	✓	✓		BRR320310	Sol					
D13098424	✓	✓		BRR320310	Sol					unidades con 4 birlos
D13098424	✓	✓		BRR320310	Sol					
COOPER S										
D94078420	✓	✓		BRR320210	Sol					
				BRR320210	Sol					
D13098424	✓	✓		BRR320210	Sol					
				BRR320310	Sol					
				BRR320210	Sol					
D13098424	✓	✓		BRR320310	Sol					
D13098424	✓	✓		BRR320310	Sol					
D94078420	✓	✓		BRR320210	Sol					
				BRR320210	Sol					
				BRR320310	Sol					
D13098424	✓	✓		BRR320310	Sol					
D13098424	✓	✓		BRR320310	Sol					
D13098424	✓	✓		BRR320310	Sol					
				BRR320310	Sol					
D15548764	✓	✓								



				EJE DELANTERO						
				 PASTILLA  	 ROTOR	TIPO	CILINDRO MAESTRO	MEDIDA mm - in		
MINI										
COOPER S cont.										
Countryman	1.6L	2016	D12048324	✓	✓					
Coupé		12-14	D12048324	✓	✓					
		15-16	D12048324	✓	✓	BFR320610	Vent			
Paceman	1.6L 184hp 4X4	2013	D12048324	✓	✓					
		14-16	D12048324	✓	✓					
Roadster		13-16	D12048324	✓	✓					
JOHN COOPER WORKS										
		2006	D12048324	✓	✓					
		1.6L	09-15							
Convertible		2008	D12048324	✓	✓					
		12-15								
Countryman	1.6t 218hp	13-17	D12048324	✓	✓					
Coupé		12-16								
GP	1.6t 218hp	13-14								
Paceman	1.6t 218hp	13-16	D12048324	✓	✓					
Roadster		13-16								
MITSUBISHI										
ASX										
		13-15	D86677410	✓	✓	BFR111410	Vent			
ECLIPSE / GT										
		03-05	D86677410	✓	✓	BFR540310	Vent			
		06-12	D86677410	✓	✓					
ECLIPSE CROSS										
		19-20								
ENDEAVOR										
		04-07	D86777420	✓	✓	BFR540610	Vent	BMC10300	25.4	1"
		08-10	D86777420	✓	✓	BFR540610	Vent	BMC10445	25.4	1"
		2011	D86777420	✓	✓	BFR540610	Vent	BMC10300	25.4	1"
GALANT										
ES		2003	D86677410	✓	✓	BFR540310	Vent			
		04-05	D86677410	✓	✓	BFR540310	Vent			
		06-09	D86677410	✓	✓	BFR540310	Vent			
GTS		05-06	D86677410	✓	✓					
GTS Ralliart		07y09	D86677410	✓	✓					
LS		2003	D86677410	✓	✓	BFR540310	Vent			
GRANDIS										
		07-09	D86777420	✓	✓	BFR540610	Vent			

		EJE TRASERO						
PASTILLA / ZAPATA			 ROTOR / TAMBOR	TIPO	 CILINDRO DE RUEDA	MEDIDA mm - in	I / D	
MINI								
COOPER S cont.								
D13098424	✓	✓	BRR320310	Sol				
D13098424	✓	✓	BRR320310	Sol				
D15548764	✓	✓						
D13098424	✓	✓	BRR320310	Sol				
JOHN COOPER WORKS								
			BRR320210	Sol				
D13098424	✓	✓						
			BRR320210	Sol				
D13098424	✓	✓						
D13098424	✓	✓						
D13098424	✓	✓						
D13098424	✓	✓						
D13098424	✓	✓						
D13098424	✓	✓						
MITSUBISHI								
ASX								
D16798908	✓	-	BRR112410	Sol				
ECLIPSE / GT								
ECLIPSE CROSS								
			BRR541010	Sol				
ENDEAVOR								
D86877430	✓	✓	BRR540510	Sol				
D86877430	✓	✓	BRR540510	Sol				
D86877430	✓	✓	BRR540510	Sol				
GALANT								
								(1) Sin control de tracción
			BRR540410	Sol				(1) con ABS
			BRR540410	Sol				
			BRR540410	Sol				
GRANDIS								
D86877430	✓	✓	BRR540510	Sol				



		  2012... 2013... 2014...	EJE DELANTERO						 PASTILLA		 ROTOR		 TIPO		 CILINDRO MAESTRO		 MEDIDA mm - in	
																		
MITSUBISHI																		
L-200																		
		08-15	D15198728 ⁽¹⁾	✓	✓	BFR540910	Vent	BMC10496 ⁽³⁾	23.8	15/16"								
			D12148334 ⁽²⁾	✓	—			BMC10513 ⁽⁴⁾	23.8	15/16"								
		16->	D15198728	✓	✓	BFR540910	Vent											
LANCER																		
DE / ES		04-07	D90477820	✓	—	BFR541010	Vent	BMC10538	22.2	7/8"								
DE	2 discos	08-09	D86677410	✓	✓	BFR111910	Vent											
ES	4 discos	08-16	D86677410	✓	✓	BFR111910	Vent	BMC10542	20.6	13/16"								
LS		04-07	D90477820	✓	—	BFR541010	Vent	BMC10538	22.2	7/8"								
GTS	2.4L	08-16	D86677410	✓	✓	BFR111410	Vent	BMC10542	20.6	13/16"								
Ralliart	2.4L	05-06	D86677410	✓	✓	BFR540310	Vent											
MIRAGE																		
		15-19	CMD17318956	—	✓	BFR541410	Vent	BMC10579	19.1	3/4"								
G4		2019	CMD17318956	—	✓	BFR541410	Vent	BMC10579	19.1	3/4"								
MONTERO																		
Limited		03-06	D86777420	✓	✓	BFR540410	Vent											
		08-19	D97678770	✓	✓													
Sport		03-04	D53074120	✓	—	BFR540510	Vent											
		05-08	D53074120	✓	—	BFR540410	Vent											
		09-15	D15198728	✓	✓	BFR540910	Vent											
		18-19				BFR541210	Vent											
OUTLANDER																		
	L4	2004	D86677410	✓	✓	BFR540310	Vent	BMC10512 ⁽¹⁾	25.4	1"								
		2005	D72374120	✓	—	BFR540810	Vent	BMC10512	25.4	1"								
		2006	D72374120	✓	—	BFR540810	Vent											
		07-13	D86683380	✓	✓	BFR111410	Vent	BMC10542	20.6	13/16"								
		14-21	D86683380	✓	✓	BFR111410	Vent											
Limited	V6	09-12	D86683380	✓	✓	BFR111410	Vent	BMC10542	20.6	13/16"								
		2013	D86683380	✓	✓	BFR111410	Vent	BMC10542	20.6	13/16"								
	L4	14-21	D86683380	✓	✓	BFR111410	Vent											
NISSAN																		
ALMERA																		
		01-05	D11478257	✓	—	BFR521310 ⁽¹⁾	Vent											
						BFR521610 ⁽²⁾	Vent											
ALTIMA																		
		96-98	D43073180	✓	✓	BFR521310	Vent											
		99-01	D43073180	✓	✓	BFR521310	Vent											
		02-06	D43073180	✓	✓	BFR522110	Vent	BMC10266 ⁽¹⁾	23.8	15/16"								
								BMC10356 ⁽²⁾	23.8	15/16"								

PASTILLA / ZAPATA				ROTOR / TAMBOR	TIPO	CILINDRO DE RUEDA	MEDIDA mm - in		I / D	
MITSUBISHI										
L-200										
S10161685				BRD540510		WBC50298	22.2	7/8"	Izq	(1) con sistema Tokico (2) con sistema Sumitomo (3) sin ABS (4) con ABS
S10161685				BRD540510						
LANCER										
S77815280						WBC50181	19.1	3/4"	D/I	
S92416240						WBC50181	19.1	3/4"	D/I	
D10377940	✓	✓		BRR112210	Sol					
S77815280						WBC50181	19.1	3/4"	D/I	
D86877430	✓	✓		BRR112410	Sol					
D10377940	✓	✓								
MIRAGE										
S10591717										
S10591717										
MONTERO										
D86877430	✓	✓		BRR540310	Vent					
D60674870	✓	-								
S72814990						WBC50253	22.2	7/8"	Der	
S72814990						WBC50253	22.2	7/8"	Der	
OUTLANDER										
						WBC50167	(1) 20.6	13/16"	D/I	(1) con ABS
D10377940	✓	✓								
D10377940	✓	✓								
D86877430	✓	✓		BRR112410	Sol					
D16798908	✓	-		BRR541010	Sol					
D86877430	✓	✓		BRR540810	Sol					
D16798908	✓	-		BRR540810	Sol					
D16798908	✓	-		BRR541010	Sol					
NISSAN										
ALMERA										
D11878305	✓	-		BRR520810	Sol					(1) de 280 mm (2) de 246 mm
ALTIMA										
S67114570						WBC50252	19.1	3/4"	D/I	
S67114570						WBC50159	19.1	3/4"	D/I	
D90577840	✓	✓		BRR521110	Sol					(1) sin ABS (2) con ABS



		2012... 2013... 2014...	EJE DELANTERO							
			PASTILLA	SM	CM	ROTOR	TIPO	CILINDRO MAESTRO	MEDIDA mm - in	
NISSAN										
ALTIMA cont.										
		07-09	D43073180	✓	✓	BFR523610	Vent	BMC10412	23.8	15/16"
		10-12	D43073180	✓	✓	BFR522110	Vent	BMC10412	23.8	15/16"
		13-19	D16508878	✓	✓	BFR525410	Vent			
SE-R		05-06	D96978700	✓	✓	BFR522410	Vent	BMC10356	23.8	15/16"
APRIO										
		08-10	D11468256	✓	✓	BFR350610	Vent	BMC10570 ⁽¹⁾	20.6	13/16"
								BMC10614 ⁽²⁾	20.6	13/16"
		2010	D11468256	✓	✓					
ARMADA										
		04-06	D10157918	✓	—	BFR523310	Vent	BMC10361 ⁽¹⁾	30.1	1 3/16"
								BMC10362 ⁽²⁾	30.1	1 3/16"
		07-11	D12868403	✓	✓	BFR523310	Vent	BMC10361 ⁽¹⁾	30.1	1 3/16"
								BMC10362 ⁽²⁾	30.1	1 3/16"
		12-15	D15098403	✓	✓	BFR524710	Vent	BMC10361 ⁽¹⁾	30.1	1 3/16"
								BMC10362 ⁽²⁾	30.1	1 3/16"
		2017	D15098403	✓	✓	BFR524710	Vent	BMC10361 ⁽¹⁾	30.1	1 3/16"
		18-20	D15098403	✓	✓					
DATSUN										
		79-80						BMC10126	22.2	7/8"
		81-84						BMC10126	22.2	7/8"
FRONTIER										
	L4	01-02	D33372280	✓	—	BFR523010	Vent	BMC10177	25.4	1"
		03-04	D33372280	✓	—	BFR523010	Vent	BMC10295 ⁽¹⁾	25.4	1"
								BMC10297 ⁽²⁾	25.4	1"
		06-08	D10948200	✓	✓	BFR523910	Vent	BMC10368 ⁽¹⁾	25.4	1"
								BMC10369 ⁽²⁾	25.4	1"
		2011	D10948200	✓	✓	BFR523910	Vent	BMC10330 ⁽¹⁾	25.4	1"
								BMC10371 ⁽²⁾	25.4	1"
		12-15	D10948200	✓	✓	BFR523910	Vent	BMC10437 ⁽¹⁾	25.4	1"
		16-17	D19119141	✓	—	BFR626050	Vent	BMC10601	25.4	1"
		17->	D19119141	✓	—	BFR626050	Vent	BMC10601	25.4	1"
	V6	01-02	D33372280	✓	—	BFR523210	Vent			







		EJE TRASERO							
PASTILLA / ZAPATA			TIPO		MEDIDA mm - in		I / D		
NISSAN									
ALTIMA cont.									
D90577840	✓	✓	BRR521110	Sol					
D90577840	✓	✓	BRR521110	Sol					
D90577840	✓	✓	BRR521110	Sol					
D90577840	✓	✓	BRR521110	Sol					
APRIO									
S10291695			BRD350210		WBC50292	19.1 3/4"	D/I	(1) con tomas depósito separadas (2) con tomas depósito juntas (3) con balero doble instalado	
			BRD350220 (3)						
S10291695			BRD350210		WBC50292	19.1 3/4"	D/I	(1) con balero doble instalado	
			BRD350220 (1)						
ARMADA									
D10417945	✓	✓	BRR521210	Sol				(1) control dinámico / sin frenos activos (2) cilindro ATE con control dinámico	
D10417945	✓	✓	BRR521210	Sol				(1) control dinámico / sin frenos activos (2) cilindro ATE con control dinámico	
D10417945	✓	✓	BRR521210	Sol				(1) control dinámico / sin frenos activos (2) cilindro ATE con control dinámico	
			BRR521210	Sol				(1) control dinámico / sin frenos activos	
DATSUN									
					WBC50228	20.6 13/16"	D/I		
					WBC50228	20.6 13/16"	D/I		
					WBC50104	19.1 3/4"	D/I		
FRONTIER									
S57413990			BRD521310		WBC50278	22.2 7/8"	D/I		
S57413990			BRD521310		WBC50278	22.2 7/8"	D/I	(1) 2WD (2) 4WD, sin control dinámico	
D11008206	✓	-	BRR521910	Vent				(1) con 3 puertos, T/A (2) con 3 puertos, T/M	
D11008206	✓	-	BRR521910	Vent				(1) T/A (2) T/M	
D11008206	✓	-	BRR521910	Vent				(1) con 2 puertos, T/A	
S10961742			BRD522210		WBC50331	25.4 1"	D/I		
S10961742			BRD522210		WBC50369	25.4 1"	D/I		
S63114330			BRD520710		WBC50277	20.6 13/16"	D/I		



		2012... 2013... 2014...	EJE DELANTERO						MEDIDA mm - in	
			PASTILLA	SM	CM	ROTOR	TIPO	CILINDRO MAESTRO		
NISSAN										
FRONTIER cont.										
V6	03-04	D83077030	✓	✓	BFR521710	Vent	BMC10295 ⁽¹⁾	25.4	1"	
							BMC10297 ⁽²⁾	25.4	1"	
	08-09	D10948200	✓	✓	BFR524010	Vent	BMC10330 ⁽¹⁾	25.4	1"	
							BMC10371 ⁽²⁾	25.4	1"	
							BMC10370 ⁽³⁾	25.4	1"	
	2010	D10948200	✓	✓	BFR524010	Vent	BMC10437 ⁽¹⁾	25.4	1"	
							BMC10368 ⁽²⁾	25.4	1"	
							BMC10369 ⁽³⁾	25.4	1"	
PRO-4X	11-15	D10948200	✓	✓	BFR524010	Vent	BMC10437 ⁽¹⁾	25.4	1"	
SV V6	2011	D10948200	✓	✓	BFR524010	Vent	BMC10437 ⁽¹⁾	25.4	1"	
HIKARI										
	88-91	D23371550	✓	-	BFR520710	Sol	BMC10122	15/16" & 3/4"		
							BMC10470	15/16" & 3/4"		
ICHI VAN										
	87-94	D26571700	✓	-			BMC10495	23.8	15/16"	
JUKE										
	12-17	D43073180	✓	✓						
KICKS										
	17-20	CMD20389269	-	✓	BFR526110	Vent				
LEAF										
	2012									
	15-17	D16508878	✓	✓	BFR526310	Vent				
	2019									
LUCINO										
	96-00	D66875460 ⁽³⁾	✓	-			BMC10168 ⁽¹⁾	22.2	7/8"	
							BMC10169 ⁽²⁾	22.2	7/8"	
MARCH										
	12-20	D15928804	✓	✓	BFR525110	Vent	BMC10315	22.2	7/8"	
MAXIMA										
	90-93	D43073180	✓	✓						
	95-99	D43073180	✓	✓						
	00-01	D43073180	✓	✓						

PASTILLA / ZAPATA		SM CM		ROTOR / TAMBOR	TIPO	CILINDRO DE RUEDA	MEDIDA mm - in	I / D	EJE TRASERO		i	
NISSAN												
FRONTIER cont.												
S63114330				BRD520710		WBC50144	22.2 7/8"	D/I	(1) 2WD (2) 4WD, sin control dinámico			
D11008206	✓	—		BRR521910	Vent				(1) con 2 puertos, 2WD y T/A (2) con 2 puertos, 2WD y T/M (3) con 4 puertos, 4WD y T/A			
D11008206	✓	—		BRR521910	Vent				(1) con 2 puertos, T/A (2) con 3 puertos, T/A (3) con 3 puertos, T/M			
D11008206	✓	—		BRR521910	Vent				(1) con 2 puertos, T/A			
D11008206	✓	—		BRR521910	Vent				(1) con 2 puertos, T/A			
HIKARI												
						WBC50104	19.1 3/4"	D/I				
ICHI VAN												
						WBC50236	20.6 13/16"	D/I				
JUKE												
D90577840	✓	✓		BRR521110	Sol							
KICKS												
S11061751				BRD522110		WBC50367	19.1 3/4"	Izq				
						WBC50366	19.1 3/4"	Der				
LEAF												
D90577840	✓	✓										
D90577840	✓	✓		BRR521610	Vent							
D90577840	✓	✓		BRR521610	Vent							
LUCINO												
				BRR520410	Sol				(1) sin ABS (2) con ABS (3) excepto GSR			
MARCH												
S10201689				BRD521910 BRD521920 (1)		WBC50310	19.1 3/4"	D/I	(1) con balero doble integrado			
MAXIMA												
D54074210	✓	—										
S60713810						WBC50252	19.1 3/4"	D/I				
D54074210	✓	—							(1) sin ABS			
D54074210	✓	—										



		 2012... 2013... 2014...	EJE DELANTERO						 PASTILLA				 ROTOR	TIPO	CILINDRO MAESTRO	MEDIDA mm - in	
NISSAN																	
MAXIMA cont.																	
	02-03	D43073180	✓	✓	BFR522110	Vent											
	04-05	D96978700	✓	✓			BMC10291	⁽¹⁾	23.8	15/16"							
								BMC10292	⁽²⁾	23.8	15/16"						
	06-08	D96978700	✓	✓	BFR522410	Vent	BMC10291	⁽¹⁾	23.8	15/16"							
							BMC10292	⁽²⁾	23.8	15/16"							
	09-15	D13748449	✓	✓	BFR522410	Vent	BMC10412		23.8	15/16"							
16-18	D13748449	✓	✓	BFR522410	Vent												
19->				BFR522410	Vent												
MICRA																	
	05-07				BFR350610	Vent											
MURANO																	
	2004	D96978700	✓	✓			BMC10443	⁽¹⁾	25.4	1"							
							BMC10444	⁽²⁾	25.4	1"							
	04-08	D96978700	✓	✓	BFR522410	Vent	BMC10443	⁽¹⁾	25.4	1"							
							BMC10444	⁽²⁾	25.4	1"							
	2009	D96978700	✓	✓	BFR522410	Vent	BMC10391		25.4	1"							
10-14	D96978700	✓	✓	BFR522410	Vent	BMC10391		25.4	1"								
19-20	CMD16498877	—	✓	BFR525510	Vent												
NOTE																	
	14-19	D15928804	✓	✓	BFR525110	Vent	BMC10315		22.2	7/8"							
NV2500																	
	13-15	D14118523	✓	—													
PATHFINDER																	
	97-98	D69175660	✓	—	BFR521710	Vent											
	99-01	D69175660	✓	—	BFR522310	Vent											
	02-04	D85575660	✓	✓	BFR522310	Vent	BMC10281	⁽¹⁾	25.4	1"							
							BMC10262	⁽²⁾	25.4	1"							
	05-09	D10948200	✓	✓	BFR524010	Vent	BMC10370	⁽¹⁾	25.4	1"							
							BMC10368	⁽²⁾	25.4	1"							
	2010	D10948200	✓	✓	BFR524010	Vent	BMC10437		25.4	1"							
	2011	D12868403	✓	✓	BFR524010	Vent	BMC10437		25.4	1"							
2012	D10948200	✓	✓	BFR524010	Vent	BMC10437		25.4	1"								
13->	CMD16498877	—	✓	BFR525510	Vent												
PICK UP																	
720	76-79																
	80-85						BMC10488		23.8	15/16"							
							BMC10123	⁽¹⁾	23.8	15/16"							
	86-88					BMC10488		23.8	15/16"								
						BMC10476	⁽¹⁾	25.4	1"								

		EJE TRASERO							
PASTILLA / ZAPATA			TIPO		MEDIDA mm - in		I / D		
NISSAN									
MAXIMA cont.									
D90077770	✓	—							
D90577840	✓	✓							
D90577840	✓	✓	BRR521110	Sol				(1) sin control de estabilidad (2) con control de estabilidad	
D90577840	✓	✓	BRR521110	Sol				(1) sin control de estabilidad (2) con control de estabilidad	
D90577840	✓	✓	BRR521810	Vent					
D90577840	✓	✓	BRR521810	Vent					
D90577840	✓	✓	BRR521810	Vent					
MICRA									
MURANO									
D90577840	✓	✓	BRR521310	Vent				(1) sin control dinámico (2) con control dinámico	
D90577840	✓	✓	BRR521310	Vent				(1) sin control dinámico (2) con control dinámico	
D90577840	✓	✓	BRR521310	Vent					
D14158405	✓	✓	BRR521310	Vent					
D90577840	✓	✓	BRR521310	Vent					
NOTE									
S10201689			BRD521910 BRD521920 (1)		WBC50310	19.1 3/4"	D/I	(1) con balero doble integrado	
NV2500									
D15658774	✓	—							
PATHFINDER									
S63114330			BRD520710		WBC50277	20.6 13/16"	D/I		
S63114330			BRD520710		WBC50144	22.2 7/8"	D/I		
S63114330			BRD520710		WBC50180	22.2 7/8"	D/I	(1) con control dinámico (1) sin control dinámico	
D11018204	✓	✓	BRR522010	Vent				(1) 4WD (2) 2WD	
D11018204	✓	✓	BRR522010	Vent					
D11018204	✓	✓	BRR522010	Vent					
D11018204	✓	✓	BRR522010	Vent					
D14158405	✓	✓	BRR521310	Vent					
PICK UP									
					WBC50216 (1)	19.1 3/4"	D/I	(1) con cilindro original Tokico	
					WBC50216 (2)	19.1 3/4"	D/I	(2) con cilindro original Tokico (1) con cilindro original Nabco	
					WBC50251	23.8 15/16"	D/I	(1) con alerta de nivel bajo	



		2012... 2013... 2014...	EJE DELANTERO							MEDIDA mm - in	
			PASTILLA	SM	CM	ROTOR	TIPO	CILINDRO MAESTRO			
NISSAN											
PICK UP cont.											
720		1989	D26571700	✓	—	BFR520610	Vent	BMC10488	23.8	15/16"	
								BMC10476	(1)	25.4	1"
		90-92	D26571700	✓	—	BFR520610	Vent	BMC10123	(1)	23.8	15/16"
								BMC10476	(2)	25.4	1"
D-21		93-94	D26571700	✓	—	BFR520610	Vent	BMC10476	(1)	25.4	1"
		1995	D33372280	✓	—	BFR520410	Vent	BMC10476	(1)	25.4	1"
		96-97	D33372280	✓	—	BFR520410	Vent	BMC10488	23.8	15/16"	
								BMC10123	(1)	23.8	15/16"
								BMC10177	25.4	1"	
98-01	D33372280	✓	—	BFR520410	Vent	BMC10488	23.8	15/16"			
						BMC10123	(1)	23.8	15/16"		
						BMC10177	25.4	1"			
D-22		08-10	D33372280	✓	—	BFR520410	Vent	BMC10488	23.8	15/16"	
								BMC10123	(1)	23.8	15/16"
NP300	D-23	09-14	D33372280	✓	—	BFR520410	Vent	BMC10529	23.8	15/16"	
2015		D33372280	✓	—	BFR520410	Vent	BMC10561	23.8	15/16"		
16-17		D19119141	✓	—	BFR526510	Vent	BMC10601	25.4	1"		
17->		D19119141	✓	—	BFR526510	Vent	BMC10601	25.4	1"		
Diesel		09-15	D33372280	✓	—	BFR520410	Vent	BMC10561	23.8	15/16"	
PLATINA											
		02-10	D11468256	✓	✓	BFR350610	Vent	BMC10120	20.6	13/16"	
QUEST											
		97-98	D57674560	✓	—	BFR520110	Vent	BMC10137	(1)	25.4	1"
								BMC10138	(2)	25.4	1"
		99-02	D57674560	✓	—	BFR520110	Vent	BMC10137	25.4	1"	
04-09	D85575660	✓	✓	BFR524110	Vent	BMC10288	(1)	25.4	1"		
						BMC10289	(2)	25.4	1"		
ROGUE											
		08-13	D13388449	✓	✓	BFR520810	Vent	BMC10433	23.8	15/16"	
		2014	CMD17378449	—	✓	BFR520810	Vent				
SAMURAI / NINJA											
		83-84						BMC10122	(1)	15/16" & 3/4"	
								BMC10470	(2)	15/16" & 3/4"	
		85-87	D23371550	✓	—	BFR520310	Sol				
SENTRA											
GSS		96-00				BFR521610	Vent	BMC10169	(1)	22.2	7/8"
GST			D66875460	✓	—	BFR521510	Vent	BMC10167	(2)	20.6	13/16"







EJE TRASERO								i
PASTILLA / ZAPATA	SM	CM	ROTOR / TAMBOR	TIPO	CILINDRO DE RUEDA	MEDIDA mm - in	I / D	
NISSAN								
PICK UP cont.								
					WBC50251	23.8 15/16"	D/I	(1) con alerta de nivel bajo
					WBC50278	22.2 7/8"	D/I	(1) con cilindro original Nabco
					WBC50103	20.6 13/16"	D/I	(2) con alerta de nivel bajo
S57413990			BRD521310		WBC50278	22.2 7/8"	D/I	(1) con alerta de nivel bajo
S57413990			BRD521310		WBC50278	22.2 7/8"	D/I	(1) con alerta de nivel bajo
S57413990			BRD521310		WBC50278	22.2 7/8"	D/I	(1) con cilindro original Nabco
					WBC50217	20.6 13/16"	D/I	
S57413990			BRD521310		WBC50278	22.2 7/8"	D/I	(1) con cilindro original Nabco
					WBC50217	20.6 13/16"	D/I	
					WBC50251	23.8 15/16"	D/I	
S57413990			BRD521310		WBC50217	20.6 13/16"	D/I	(1) con cilindro original Nabco
					WBC50251	23.8 15/16"	D/I	
S57413990			BRD521310		WBC50217	20.6 13/16"	D/I	
S57413990			BRD521310		WBC50144	22.2 7/8"	D/I	
S10941740			BRD520710		WBC50339	23.8 15/16"	D/I	
S10961742			BRD522210		WBC50331	25.4 1"	D/I	
S10961742			BRD522210		WBC50369	25.4 1"	D/I	
S63114330			BRD520710		WBC50339	23.8 15/16"	D/I	
S10941740 (1)			BRD521310 (1)		WBC50357 (1)	23.8 15/16"	D/I	(1) sólo 2013-15
PLATINA								
S10291695			BRD350210		WBC50121	17.8 45/64"	D/I	(1) con balero doble instalado
			BRD350220 (1)					
QUEST								
S66514520					WBC50270	25.4 1"	D/I	(1) con ABS (2) sin ABS
S66514520					WBC50149	25.4 1"	D/I	
D90577840	✓	✓	BRR521310	Vent				(1) T/A de 4 velocidades (2) T/A de 5 velocidades
ROGUE								
D90577840	✓	✓	BRR521610	Vent				
D90577840	✓	✓	BRR521610	Vent				
SAMURAI / NINJA								
					WBC50236	20.6 13/16"	D/I	(1) con cilindro original Tokico (2) con cilindro original Tokico
S53213730								
SENTRA								
			BRR520410	Sol				(1) con ABS
S63814380			BRD520810		WBC50276	15.8 5/8"	D/I	(2) sin ABS, con cilindro original Tokico



			EJE DELANTERO							
			PASTILLA			ROTOR	TIPO	CILINDRO MAESTRO	MEDIDA mm - in	
NISSAN										
SENTRA cont.										
GSX		96-00	D66875460	✓	—	BFR521510	Vent	BMC10168 ⁽³⁾	22.2	7/8"
SE	2.0L	2001	D43073180	✓	✓	BFR521310	Vent	BMC10254	23.8	15/16"
XE / GXE		2001	D48573420	✓	✓	BFR523110	Vent	BMC10255 ⁽¹⁾	23.8	15/16"
								BMC10256 ⁽²⁾	23.8	15/16"
		02-06	D48573420	✓	✓	BFR523110	Vent	BMC10255 ⁽¹⁾	23.8	15/16"
								BMC10256 ⁽²⁾	23.8	15/16"
LE	2.5L	03-04	D43073180	✓	✓	BFR521310	Vent	BMC10254	23.8	15/16"
		07-10	D43073180	✓	✓	BFR524410	Vent	BMC10420 ⁽¹⁾	23.8	15/16"
		10-12	D43073180	✓	✓	BFR524410	Vent	BMC10534 ⁽¹⁾	23.8	15/16"
		13-17	D81585300	✓	✓	BFR525810	Vent	BMC10575 ⁽¹⁾	23.8	15/16"
								BMC10574 ⁽²⁾	23.8	15/16"
		18-19	D81585300	✓	✓	BFR525810	Vent			
		20->	CMD23109545	—	✓					
Nismo	1.6T	18-19	D81585300	✓	✓	BFR525810	Vent			
SE-R		02-05	D43073180	✓	✓	BFR521310	Vent	BMC10103	23.8	15/16"
		2006	D43073180	✓	✓			BMC10103	23.8	15/16"
		07-08	D13388449	✓	✓	BFR523510	Vent	BMC10103	23.8	15/16"
		09-12	D13748449	✓	✓	BFR523510	Vent	BMC10534 ⁽¹⁾	23.8	15/16"
SR	1.6T	2017	D81585300	✓	✓	BFR525810	Vent			
TIIDA										
	1.8L	07-12	D13458456	✓	✓	BFR523710	Vent	BMC10390 ⁽¹⁾	23.8	15/16"
		13-18	D13458456	✓	✓	BFR523710	Vent	BMC10265	22.2	7/8"
TITAN										
		04-05	D10157918	✓	—	BFR523310	Vent	BMC10298 ⁽¹⁾	28.5	1 1/8"
								BMC10294 ⁽²⁾	28.5	1 1/8"
								BMC10361 ⁽³⁾	30.1	1 3/16"
		05-07	D10157918	✓	—			BMC10298 ⁽¹⁾	28.5	1 1/8"
							BMC10294 ⁽²⁾	28.5	1 1/8"	
							BMC10361 ⁽³⁾	30.1	1 3/16"	
		08-10	D12868403	✓	✓	BFR524710	Vent	BMC10361 ⁽¹⁾	30.1	1 3/16"
		11-15	D15098403	✓	✓	BFR524710	Vent	BMC10361 ⁽¹⁾	30.1	1 3/16"
TSUBAME										
		93-04	D51073890	✓	✓	BFR522210	Vent	BMC10131	19.1	3/4"
TSURU										
I		84-87	D23371550	✓	—	BFR520310	Sol	BMC10122 ⁽¹⁾	15/16" & 3/4"	
								BMC10470 ⁽²⁾	15/16 & 3/4"	







PASTILLA / ZAPATA		SM CM		ROTOR / TAMBOR		TIPO	CILINDRO DE RUEDA		MEDIDA mm - in	I / D	i
NISSAN											
SENTRA cont.											
				BRR520410	Sol						(3) sin ABS
D54074210	✓	—		BRR520810	Sol						
S76215250				BRD521510		WBC50173	(3)	17.4	11/16"	D/I	(1) con ABS (2) sin ABS
							WBC50174	(4)	15.8	5/8"	D/I
S77915250				BRD521510		WBC50174	(3)	15.8	5/8"	D/I	(1) con ABS (2) sin ABS
							WBC50182	(4)	15.8	5/8"	D/I
D90077770	✓	—									
S91914620				BRD521810		WBC50203		19.1	3/4"	D/I	(1) T/M
S91914620				BRD521810		WBC50203		19.1	3/4"	D/I	(1) T/M
S10461708				BRD522010		WBC50338		19.1	3/4"	D/I	(1) T/M (2) CVT
D90577840	✓	✓		BRR521110	Sol						
CMD23069541	—	✓									
D90577840	✓	✓		BRR521110	Sol						
D90077770	✓	—									
D90077770	✓	—									
D90577840	✓	✓		BRR521110	Sol						
D90577840	✓	✓		BRR521110	Sol						(1) T/M
D90577840	✓	✓		BRR521110	Sol						
TIIDA											
S92416240				BRD521710		WBC50203		19.1	3/4"	D/I	(1) T/M
S92416240				BRD521710		WBC50204	(1)	17.4	11/16"	D/I	(1) sin ABS
						WBC50205	(2)	15.8	5/8"	D/I	(2) con ABS
TITAN											
D10417945	✓	✓		BRR521210	Sol						(1) con 2 puertos, 2WD (2) con 4 puertos, 4WD sin control dinámico (3) con 4 puertos, con control dinámico
D10417945	✓	✓		BRR521210	Sol						(1) con 2 puertos, 2WD (2) con 4 puertos, 4WD sin control dinámico (3) con 4 puertos, con control dinámico
D10417945	✓	✓		BRR521210	Sol						(1) con 4 puertos, excepto frenos activos
D10417945	✓	✓		BRR521210	Sol						(1) con 4 puertos
TSUBAME											
S60713810						WBC50234		17.4	11/16"	D/I	
TSURU											
S53213730						WBC50104		19.1	3/4"	D/I	(1) con cilindro original Tokico (2) con cilindro original Tokico



	  2012... 2013... 2014...	EJE DELANTERO						
		 PASTILLA			 ROTOR	TIPO	 CILINDRO MAESTRO	MEDIDA mm - in
NISSAN								
TSURU cont.								
II	88-91	D23371550	✓	—	BFR520710	Sol	BMC10122 ⁽¹⁾ BMC10470 ⁽²⁾	15/16" & 3/4" 15/16" & 3/4"
GS	92-17	D51073890	✓	✓	BFR520710 BFR522210	Sol Vent	BMC10131	19.1 3/4"
GSR 2000	93-96						BMC10168	22.2 7/8"
URVAN								
	00-01	D33372280	✓		BFR520410	Vent		
	02-13	D11918310	✓	✓	BFR520510	Vent	BMC10125	25.4 1"
Urvan NV350	14->	D11918310	✓	✓	BFR520510	Vent	BMC10562	25.4 1"
VERSA								
	12-19	D15928804	✓	✓	BFR525110	Vent	BMC10315	22.2 7/8"
	20->	CMD20389269	—	✓	BFR526110	Vent		
X-TERRA								
	00-02	D83077030	✓	✓	BFR521710	Vent		
	03-04	D83077030	✓	✓	BFR521710	Vent	BMC10295 ⁽¹⁾ BMC10297 ⁽²⁾	25.4 1" 25.4 1"
	05-06	D10948200	✓	✓	BFR524010	Vent	BMC10330 ⁽¹⁾ BMC10370 ⁽²⁾ BMC10368 ⁽³⁾	25.4 1" 25.4 1" 25.4 1"
	2007	D10948200	✓	✓	BFR524010	Vent	BMC10370 ⁽¹⁾ BMC10368 ⁽²⁾	25.4 1" 25.4 1"
X-TRAIL								
	02-07	D85575660	✓	✓	BFR523410	Vent	BMC10498	25.4 1"
	08-14	D13388449	✓	✓	BFR520810	Vent	BMC10433	23.8 15/16"
	15-19	CMD17378449 ⁽¹⁾ CMD17368906 ⁽²⁾	— —	✓ ✓	BFR526310 ⁽¹⁾ BFR526410 ⁽²⁾	Vent Vent		
Hybrid	18-19	CMD17378449	—	✓				
240 SX								
	93 / 98	D48573420 ⁽¹⁾	✓	✓				
300 ZX								
	90-93							
350 Z								
	03-05	D43073180	✓	✓				
	06-08	D88877660	✓	—	BFR522410	Vent		

PASTILLA / ZAPATA		EJE TRASERO		ROTOR / TAMBOR		TIPO	CILINDRO DE RUEDA	MEDIDA mm - in		I / D	i
SM	CM										
NISSAN											
TSURU cont.											
S53213730							WBC50104	19.1	3/4"	D/I	(1) con cilindro original Tokico (2) con cilindro original Tokico
S63814380			BRD520810				WBC50276	15.8	5/8"	D/I	
			BRR520410		Sol						
URVAN											
S57413990											
S57413990			BRD521610				WBC50103	20.6	13/16"	D/I	
S57413990			BRD521310				WBC50352	19.1	3/4"	D/I	
S63114330			BRD520710				WBC50339	23.8	15/16"	D/I	
VERSA											
S10201689			BRD521910 BRD521920 (1)				WBC50310	19.1	3/4"	D/I	(1) con balero doble integrado
S11061751			BRD522110				WBC50367 WBC50366	19.1 19.1	3/4" 3/4"	Izq Der	
X-TERRA											
S63114330			BRD520710				WBC50144	22.2	7/8"	D/I	
S63114330			BRD520710				WBC50144	22.2	7/8"	D/I	(1) 2WD (2) 4WD, sin control dinámico
D11008206	✓	—	BRR521910		Vent						(1) con 2 puertos, 2WD y T/A (2) con 4 puertos, 4WD y T/A (3) con 3 puertos, T/A
D11018204	✓	✓	BRR521910		Vent						(1) con 4 puertos, 4WD y T/A (2) con 3 puertos, T/A
X-TRAIL											
D90577840	✓	✓	BRR521610		Vent						
D90577840	✓	✓	BRR521610		Vent						
D90577840	✓	✓	BRR521610		Vent						(1) 2 filas de asientos (2) 3 filas de asientos
D90577840	✓	✓	BRR521610		Vent						
240 SX											
											(1) 4 Birlos
300 ZX											
D90577840	✓	✓	BRR521610		Vent						
350 Z											
D90577840	✓	✓	BRR521610		Vent						
D90577840	✓	✓	BRR521810		Vent						



		 2012... 2013... 2014...		EJE DELANTERO						
				 PASTILLA			 ROTOR	TIPO	CILINDRO MAESTRO	MEDIDA mm - in
NISSAN										
370 Z										
Touring		08->				BFR522410	Vent			
Nismo		09-10								
PEUGEOT										
206										
CC		01-08	D15708779	✓	✓	BFR380210	Vent	BMC10105	20.6	13/16"
D-Sing		08-09	D11438254	✓	✓	BFR380110	Vent	BMC10105	20.6	13/16"
Féline		06-08	D11438254	✓	✓	BFR380110	Vent	BMC10105	20.6	13/16"
SS		2002	D00013100	✓	✓	BFR380110	Vent	BMC10105	20.6	13/16"
SW		06-08	D15708779	✓	✓	BFR380210	Vent	BMC10105	20.6	13/16"
X		05-08	D11438254	✓	✓	BFR380410	Sol	BMC10105	20.6	13/16"
XR	1.4L, 1.6L	03-07	D11438254	✓	✓	BFR380110	Vent	BMC10105	20.6	13/16"
	1.4L	00-07	D00013100	✓	✓	BFR380410	Sol	BMC10105	20.6	13/16"
XS		01-08	D15708779	✓	✓	BFR380210	Vent	BMC10105	20.6	13/16"
XT		03-07	D11438254	✓	✓	BFR380110 ⁽¹⁾	Vent	BMC10105	20.6	13/16"
			D15708779	✓	✓	BFR380210 ⁽²⁾	Vent			
207										
Compact	1.4L	09-11	D15418872	✓	✓	BFR380310	Vent			
			D15708779	✓	✓	BFR381010	Vent			
CC		08-14	D15418872	✓	✓	BFR380310	Vent			
Sedán		09-11	D15418872	✓	✓	BFR380310	Vent			
RC		08-10	D15418872	✓	✓	BFR380310	Vent			
Turbo		2008	D15418872	✓	✓	BFR380310	Vent			
208										
		14-20				BFR381010	Vent			
GT	1.6T	14-18								
Pure Tech	1.2T	19->	D15708779	✓	✓	BFR381010	Vent			
2008										
		14-16	D15708779	✓	✓	BFR381010	Vent			
						BFR380310	Vent			
		19->			BFR380310	Vent				
301										
		13->	D15708779	✓	✓					
306										
	T/A	98-02				BFR380210	Vent			
	T/M	97-02				BFR380210	Vent			
307										
		03-09	D15418872	✓	✓	BFR380310	Vent			







PASTILLA / ZAPATA		SM CM		ROTOR / TAMBOR	TIPO	CILINDRO DE RUEDA	MEDIDA mm - in			I / D
NISSAN										
370 Z										
D90577840	✓	✓		BRR521810	Vent					
D90577840	✓	✓								
PEUGEOT										
206										
D14828658	✓	✓		BRR389710	Sol					
D14828658	✓	✓		BRR389710	Sol					
D14828658	✓	✓		BRR389710	Sol					
S94216330				BRD380210		WBC50293	20.6	13/16"	Izq	
						WBC50294	20.6	13/16"	Der	
D14828658	✓	✓		BRR389710	Sol					
D14828658	✓	✓		BRR389710	Sol					
D14828658	✓	✓		BRR389710	Sol					
S94216330				BRD380210		WBC50293	20.6	13/16"	Izq	
						WBC50294	20.6	13/16"	Der	
D14828658	✓	✓		BRR389710	Sol					
D14828658	✓	✓		BRR389710	Sol					(1) diámetro de 247 mm (2) diámetro de 266 mm
207										
				BRR389710	Sol					
S94216330										
				BRR389510	Sol					
S94216330										
				BRR389510	Sol					
				BRR389510	Sol					
208										
D34073350	✓	✓		BRR389510	Sol					
D34073350	✓	✓		BRR389510	Sol					
D34073350	✓	✓		BRR389510	Sol					
2008										
D34073350	✓	✓		BRR389510	Sol					
D34073350	✓	✓		BRR389510	Sol					
301										
S00015170						WBC50360	20.6	13/16"	D/I	
306										
D14828658	✓	✓		BRR389710	Sol					
D14828658	✓	✓		BRR389710	Sol					
307										
D34073350	✓	✓		BRR389810 (1)	Sol					(1) disco sin maza
				BRR389510 (2)	Sol					(2) disco con maza



			EJE DELANTERO						PASTILLA ROTOR CILINDRO MAESTRO MEDIDA mm - in	
			SM CM	ROTOR	TIPO	CILINDRO MAESTRO				
PEUGEOT										
308										
		09-14	D11078212N	✓	✓					
		16-17	CMD19749201	-	✓					
CC		10-14				BFR380310	Vent			
RC		12-13				BFR380310	Vent			
3008										
		11-14								
405										
		97-99				BFR380210	Vent			
406										
		00-05								
607										
		02-08								
GRAND RAID										
		07-12	D15708779	✓	✓	BFR380310	Vent			
MANAGER										
435		09->	D15408748	✓	-					
PARTNER										
		04-05	D11908309	✓	-	BFR380210	Vent			
		05-06	D15708779	✓	✓	BFR381010	Vent			
		07-12	D15708779	✓	✓	BFR380310	Vent			
Maxi		13-17	D17178942	✓	✓	BFR380310	Vent	BMC10612	23.8 15/16"	
		18-19	D17178942	✓	✓	BFR380310	Vent			
		20->	CMD19749201	-	✓					
Tepee		13-19	D17178942	✓	✓	BFR380310	Vent	BMC10612 ⁽¹⁾	23.8 15/16"	
RCZ										
		11-16								
RIFTER										
		20->	CMD19749201	-	✓					
PONTIAC										
AZTEK										
	FWD	01-05				BFR134610	Vent			
	4WD	2005								
BONNEVILLE										
		94-99								
FIREBIRD / TRANS AM										
		98-01								
G2										
VER MATIZ EN CHEVROLET										

		EJE TRASERO							
PASTILLA / ZAPATA			TIPO		MEDIDA mm - in		I / D		
PEUGEOT									
308									
D34073350	✓	✓							
D34073350	✓	✓							
D34073350	✓	✓							
3008									
		BRR380310	Sol						
405									
D34072340	✓	✓							
406									
D14808679	✓	-							
607									
D14808679	✓	-							
GRAND RAID									
S10321698		BRD380110							
MANAGER									
D15708779	✓	✓							
PARTNER									
S10321698		BRD380110		WBC50113	22.2	7/8"	D/I		
S10321698		BRD380110		WBC50113	22.2	7/8"	D/I		
S10321698		BRD380110		WBC50113	22.2	7/8"	D/I		
CMD19269151	-	✓	BRR380310	Sol					
CMD19269151	-	✓	BRR380310	Sol					
CMD19269151	-	✓	BRR380310	Sol				(1) hasta 2017	
RCZ									
CMD19269151	-	✓							
RIFTER									
PONTIAC									
AZTEK									
S78015000									
		S78421990	(1)					(1) zapatas de freno de estacionamiento	
BONNEVILLE									
S63613940		BRD130610		WBC50102	(1) 23.8	15/16"	D/I	(1) hasta 1995	
FIREBIRD / TRANS AM									
		S78421990	(1)					(1) zapatas de freno de estacionamiento	
G2									



		 2012... 2013... 2014...	EJE DELANTERO						 PASTILLA		 ROTOR		 CILINDRO MAESTRO		MEDIDA mm - in	
					TIPO											
PONTIAC																
G3																
		2007	D12698385	✓	—	BFR133410	Vent									
		08-09	D10357779	✓	✓	BFR137410	Vent	BMC10500	⁽¹⁾	22.2	7/8"					
								BMC10440	⁽²⁾	22.2	7/8"					
								BMC10441	⁽³⁾	22.2	7/8"					
								BMC10442	⁽⁴⁾	22.2	7/8"					
G4																
LS		05-06	D95678550	✓	—			BMC10326	⁽¹⁾	22.2	7/8"					
GT		05-06	D10287932	✓	✓	BFR132410	Vent	BMC10326	⁽¹⁾	22.2	7/8"					
G5																
LS		07-08	D95678550	✓	—			BMC10326	⁽¹⁾	22.2	7/8"					
		2009	D95678550	✓	—											
GT		2007	D10287932	✓	✓	BFR132410	Vent	BMC10326		22.2	7/8"					
		2008	D11608270	✓	✓			BMC10326		22.2	7/8"					
		2009	D11608270	✓	✓											
G6																
GT		05-07	D10397943	✓	—	BFR132410	Vent	BMC10308		23.8	15/16"					
		08-09	D11608270	✓	✓	BFR132410	Vent	BMC10404	⁽¹⁾	23.8	15/16"					
			D10287932	✓	✓			BMC10405	⁽²⁾	23.8	15/16"					
GTP		2007	D11608270	✓	✓	BFR132410	Vent	BMC10308		23.8	15/16"					
		2008	D11608270	✓	✓	BFR132410	Vent	BMC10404	⁽¹⁾	23.8	15/16"					
								BMC10405	⁽²⁾	23.8	15/16"					
GXP		2009	D10287932	✓	✓	BFR132410	Vent	BMC10404	⁽¹⁾	23.8	15/16"					
								BMC10405	⁽²⁾	23.8	15/16"					
SE		05-06	D10287932	✓	✓	BFR132410	Vent	BMC10299		23.8	15/16"					
GRAND AM																
		99-04	D72775940	✓	—	BFR131710	Vent	BMC10235		23.8	15/16"					
GRAND PRIX																
		1997	D69975740	✓	—	BFR131810	Vent	BMC10182		25.4	1"					
		98-01	D69975740	✓	—	BFR131810	Vent	BMC10192		25.4	1"					
MONTANA SV6																
		2005	D10757980	✓	✓			BMC10192		25.4	1"					
		06-09	D10757980	✓	✓	BFR136910	Vent	BMC10340		25.4	1"					
SOLSTICE																
		06-08	D10287932	✓	✓											
SUNFIRE																
		97-99	D67375540	✓	—	BFR131110	Vent	BMC10163		22.2	7/8"					
		00-02	D67375540	✓	—	BFR131110	Vent	BMC10232		22.2	7/8"					
		04-05	D67375540	✓	—	BFR131110	Vent	BMC10232		22.2	7/8"					
TORRENT																
		05-06	D91379740	✓	—	BFR135510	Vent	BMC10250		25.4	1"					
		07-09	D12648381	✓	✓	BFR137110	Vent	BMC10387		25.4	1"					







PASTILLA / ZAPATA		ROTOR / TAMBOR		TIPO	CILINDRO DE RUEDA	MEDIDA mm - in		I / D	i
PONTIAC									
G3									
S81415470			BRD133710		WBC50210	19.1	3/4"	D/I	
S81415470			BRD133710		WBC50210	19.1	3/4"	D/I	(1) T/A sin ABS (2) T/A con ABS (3) T/M con ABS (4) T/M sin ABS
G4									
S79515350					WBC50191	20.6	13/16"	D/I	(1) T/A
D10337937	✓	✓	BRR132610	Sol					(1) T/A
G5									
S86015350					WBC50191	20.6	13/16"	D/I	(1) T/A
S86015350									(1) T/A
D10337937	✓	✓	BRR132610	Sol					
D10337937	✓	✓	BRR132610	Sol					
D10337937	✓	✓	BRR132610	Sol					(1) T/A
G6									
D10337937	✓	✓	BRR132610	Sol					
D10337937	✓	✓	BRR132610	Sol					(1) con puertos de 13 x 1.5 mm (2) con puertos de 14 x 1.5 mm
D10337937	✓	✓	BRR132610	Sol					
D10337937	✓	✓	BRR132610	Sol					(1) con puertos de 13 x 1.5 mm (2) con puertos de 14 x 1.5 mm
D10337937	✓	✓	BRR132610	Sol					(1) con puertos de 13 x 1.5 mm (2) con puertos de 14 x 1.5 mm
D10337937	✓	✓	BRR132610	Sol					
GRAND AM									
GRAND PRIX									
MONTANA SV6									
D10937999	✓	-							
D10937999	✓	-	BRR133110	Sol					
SOLSTICE									
D10957957	✓	✓							
SUNFIRE									
S55321640			BRD130310		WBC50257	17.4	11/16"	D/I	
S55321640			BRD130310		WBC50257	17.4	11/16"	D/I	
S79515350									
TORRENT									
S78015000					WBC50168	22.2	7/8"	D/I	
D12758391	✓	✓	BRR133710	Vent					



			EJE DELANTERO							
			PASTILLA	SM	CM	ROTOR	TIPO	CILINDRO MAESTRO	MEDIDA mm - in	
RAM										
700										
Cabina sencilla		15-20	D15388747	✓	—	BFR390110 ⁽¹⁾ BFR390410 ⁽²⁾	Vent Vent	BMC10506 ⁽³⁾	22.2	7/8"
Cabina Externdida		15-20	CMD19709195	—	✓	BFR390110 ⁽¹⁾ BFR390410 ⁽²⁾	Vent Vent	BMC10506 ⁽³⁾	22.2	7/8"
1500										
		1994	D36972590	✓	—	BFR113010	Vent	BMC10482	28.5	1 1/8"
		95-96	D36972590	✓	—	BFR113010	Vent	BMC10158	28.5	1 1/8"
		1997	D36972590	✓	—	BFR113010	Vent	BMC10156	31.7	1 1/4"
		98-99	D78976590	✓	—	BFR113010	Vent	BMC10196	31.7	1 1/4"
		00-02	D75876270	✓	—	BFR114710	Vent	BMC10196	31.7	1 1/4"
		2002	D89777740	✓	—	BFR115310	Vent	BMC10251 ⁽¹⁾	33.3	1 5/16"
		2003	D89777740 D96678680	✓ ✓	— —	BFR115310	Vent	BMC10251 ⁽¹⁾ BMC10278 ⁽²⁾	33.3 33.3	1 5/16" 1 5/16"
		04-05	D96678680	✓	—	BFR115310	Vent	BMC10251 ⁽¹⁾ BMC10278 ⁽²⁾	33.3 33.3	1 5/16" 1 5/16"
		2006	D10847991	✓	✓	BFR115310	Vent	BMC10320	31.7	1 1/4"
		07-18	D10847991	✓	✓	BFR115310	Vent	BMC10375	31.7	1 1/4"
		19->	D21799424	✓	—					
SRT-10		05-06				BFR115310	Vent			
2500										
		1994	D36972590	✓	—	BFR113010	Vent	BMC10482	28.5	1 1/8"
		95-96	D36972590	✓	—	BFR113010	Vent	BMC10158	28.5	1 1/8"
		1997	D36972590	✓	—	BFR113010	Vent	BMC10156	31.7	1 1/4"
		98-99	D78976590	✓	—	BFR113010	Vent	BMC10196	31.7	1 1/4"
		00-02	D75876270	✓	—	BFR114710	Vent	BMC10196	31.7	1 1/4"
		2002	D89777740	✓	—	BFR115310	Vent	BMC10251 ⁽¹⁾	33.3	1 5/16"
		2003	D89777740 D96678680	✓ ✓	— —	BFR115310	Vent	BMC10251 ⁽¹⁾ BMC10278 ⁽²⁾	33.3 33.3	1 5/16" 1 5/16"
		04-05	D96678680	✓	—	BFR115310	Vent	BMC10251 ⁽¹⁾ BMC10278 ⁽²⁾	33.3 33.3	1 5/16" 1 5/16"
		2006	D10847991	✓	✓	BFR115310	Vent	BMC10320	31.7	1 1/4"
Quad Cab / Diesel		06-08	D96578640	✓	—	BFR115910	Vent	BMC10251 ⁽¹⁾ BMC10523 ⁽²⁾	33.3 33.3	1 5/16" 1 5/16"
		09-11	D13998507	✓	✓	BFR116810	Vent	BMC10251 ⁽¹⁾ BMC10348 ⁽²⁾	33.3 33.3	1 5/16" 1 5/16"







EJE TRASERO								i
PASTILLA / ZAPATA	SM	CM	ROTOR / TAMBOR	TIPO	CILINDRO DE RUEDA	MEDIDA mm - in	I / D	
RAM								
700								
S00015090					WBC50359	20.6 13/16"	D/I	(1) diámetro de 257.0 mm (2) diámetro de 284.0 mm (3) sin ABS hasta 2017
S10271693			BRD390110		WBC50361	20.6 13/16"	D/I	(1) diámetro de 257.0 mm (2) diámetro de 284.0 mm (3) sin ABS hasta 2017
1500								
					WBC50284	23.8 15/16"	D/I	
					WBC50284	23.8 15/16"	D/I	
					WBC50284	23.8 15/16"	D/I	
					WBC50284	23.8 15/16"	D/I	
S72321820					WBC50289	25.4 1"	Izq	
					WBC50290	25.4 1"	Der	
D89877750	✓	-	BRR110410	Vent				(1) con ABS en las 4 ruedas
D89877750	✓	-	BRR110410	Vent				(1) con ABS en las 4 ruedas
D96778690	✓	✓						(2) con ABS en el eje trasero
D96778690	✓	✓	BRR110410	Vent				(1) con ABS en las 4 ruedas (2) con ABS en el eje trasero
D96778690	✓	✓	BRR110410	Vent				
D96778690	✓	✓	BRR110410	Vent				
D21699414	✓	-						
D10777982	✓	-						
			S85421920 (1)					(1) zapatas de freno de estacionamiento
2500								
					WBC50284	23.8 15/16"	D/I	
					WBC50284	23.8 15/16"	D/I	
					WBC50284	23.8 15/16"	D/I	
					WBC50284	23.8 15/16"	D/I	
S72321820					WBC50289	25.4 1"	Izq	
					WBC50290	25.4 1"	Der	
D89877750	✓	-	BRR110410	Vent				(1) con ABS en las 4 ruedas
D89877750	✓	-	BRR110410	Vent				(1) con ABS en las 4 ruedas
D96778690	✓	✓						(2) con ABS en el eje trasero
D96778690	✓	✓	BRR110410	Vent				(1) con ABS en las 4 ruedas (2) con ABS en el eje trasero
D96778690	✓	✓	BRR110410	Vent				
D10777982	✓	-	BRR111810	Vent				(1) con motor 5.7L (2) con motor Diesel 5.9L
			S85421920 (3)					(3) zapatas de freno de estacionamiento
D14008508	✓	✓	BRR113110	Vent				(1) con booster de vacío (2) con booster hidráulico
			S85421920 (3)					(3) zapatas de freno de estacionamiento



		 2012... 2013... 2014...	EJE DELANTERO						
			 PASTILLA			 ROTOR	TIPO	CILINDRO MAESTRO	MEDIDA mm - in
RAM									
2500 cont.									
Quad Cab / Diesel		2012	D13998507	✓	✓	BFR116810	Vent		
Crew Cab	4X4	09-18	D10847991	✓	✓	BFR115310	Vent	BMC10375 31.7 1 1/4"	
		19->				BFR116810	Vent		
3500									
		94-97	D4597339A	✓	-				
		98-99	D4597339A	✓	-			BMC10196 31.7 1 1/4"	
	4 discos	2000				BFR112910	Vent	BMC10196 31.7 1 1/4"	
	2 discos		D82176940	✓	-				
	4 discos	01-02				BFR112910	Vent		
	2 discos		D82176940	✓	-				
4000									
		94-97	D4597339A	✓	-				
		98-99	D4597339A	✓	-			BMC10196 31.7 1 1/4"	
		00-02	D82176940	✓	-	BFR112910	Vent	BMC10196 31.7 1 1/4"	
	05-08	D96578640	✓	-	BFR115910	Vent	BMC10251 33.3 1 5/16" BMC10348 ⁽¹⁾ 33.3 1 5/16"		
	09-11	D13998507	✓	✓	BFR116810	Vent	BMC10251 33.3 1 5/16" BMC10348 ⁽¹⁾ 33.3 1 5/16"		
	12-19	D13998507	✓	✓	BFR116810	Vent			
	20->	D22239462	✓	-					
PROMASTER									
		14->	D15408748 ⁽¹⁾	✓	-	BFR117310	Vent		
			D18429070 ⁽²⁾	✓	-				
PROMASTER RAPID									
		17->	CMD19069135	-	✓	BFR390310	Vent		
VAN / WAGON									
1500		96-98	D2697179A	✓	-	BFR112310	Vent	BMC10207 31.7 1 1/4"	
		98-03	D96678680	✓	-			BMC10207 31.7 1 1/4"	

PASTILLA / ZAPATA				ROTOR / TAMBOR	TIPO	CILINDRO DE RUEDA	MEDIDA mm - in		I / D	
RAM										
2500 cont.										
D14008508	✓	✓	BRR113110	Vent						(1) zapatas de freno de estacionamiento
			S85421920	(1)						
D96778690	✓	✓	BRR110410	Vent						(1) zapatas de freno de estacionamiento
			S85421920	(1)						
3500										
S45221570						WBC50229	26.9	1 1/16"	D/I	
S45221570						WBC50229	26.9	1 1/16"	D/I	
D10967752	✓	-								(1) zapatas de freno de estacionamiento
			S77121920	(1)						
S58321710						WBC50289	25.4	1"	Izq	(1) zapatas de freno de estacionamiento
						WBC50290	25.4	1"	Der	
D10967752	✓	-								(1) zapatas de freno de estacionamiento
			S77121920	(1)						
S58321710										(1) zapatas de freno de estacionamiento
4000										
S45221570										
S45221570										
D10967752	✓	-								(1) zapatas de freno de estacionamiento
			S77121920	(1)						
S58321710										(1) zapatas de freno de estacionamiento
D10967752	✓	-	BRR111810	Vent						(1) con hidroboster
D14008508	✓	✓	BRR113110	Vent						(1) con hidroboster
D14008508	✓	✓	BRR113110	Vent						
D22259464	✓	-								
PROMASTER										
D15708779	✓	✓	BRR114010	Sol						(1) con 1 sensor
D18409068	(2)	✓	BRR114110	Vent						(2) con 2 sensores
			S10671722	(3)						(3) zapatas de freno de estacionamiento
PROMASTER RAPID										
S10271693			BRD390110			WBC50361	20.6	13/16"	D/I	
VAN / WAGON										
			BRD111810			WBC50221	23.8	15/16"	D/I	
D96778690	✓	✓								
S72321820						WBC50289	25.4	1"	Izq	
						WBC50290	25.4	1"	Der	



		 2012... 2013... 2014...		EJE DELANTERO						
				 PASTILLA			 ROTOR	TIPO	CILINDRO MAESTRO	MEDIDA mm - in
RAM										
VAN / WAGON cont.										
2500		94-98	D2697179A	✓	—	BFR112310	Vent	BMC10207	31.7 1 1/4"	
		99-02	D65575350	✓	—			BMC10207	31.7 1 1/4"	
3500		1995	D2697179A	✓	—					
		96-97	D2697179A	✓	—			BMC10207	31.7 1 1/4"	
		98-02	D65575350	✓	—			BMC10207	31.7 1 1/4"	
RENAULT										
CAPTUR										
		18->	D16278844	✓	✓					
	1.6L	02-10	D11468256	✓	✓	BFR350610	Vent	BMC10120	20.6 13/16"	
Sport	2.0L	02-04	D11458255	✓	—	BFR350510	Vent			
Euro Clio	1.6L	07-09				BFR350610	Vent			
Team Sport Trophy	2.0L	2005 2006	D11458255	✓	—	BFR350510	Vent			
DUSTER										
		13-20	D16278844	✓	✓	BFR350210	Vent			
FLUENCE										
		11-13	D16278844	✓	✓	BFR350210	Vent			
		14-17				BFR350210	Vent			
KANGOO										
		04-18	D14998254	✓	—	BFR350610	Vent	BMC10533	22.2 7/8"	
		18->	D16278844	✓	✓	BFR350510	Vent			
KANGOO MPV										
		07-09	D14998254	✓	—	BFR350610	Vent	BMC10533	22.2 7/8"	
KOLEOS										
		09-16	D13388449	✓	✓	BFR523510	Vent			
		17-19	CMD17378449	—	✓					
KWID										
		19->	CMD00012200	—	✓	BFR351010	Vent			
LAGUNA										
		03-06	D15018700	✓	—					







				EJE TRASERO							
PASTILLA / ZAPATA			ROTOR / TAMBOR	TIPO	CILINDRO DE RUEDA		MEDIDA mm - in	I / D			
RAM											
VAN / WAGON cont.											
			BRD111810		WBC50289	25.4	1"	Izq			
					WBC50290	25.4	1"	Der			
S72321820					WBC50289	25.4	1"	Izq			
					WBC50290	25.4	1"	Der			
S35821400											
S35821400					WBC50124	22.2	7/8"	Izq			
					WBC50125	22.2	7/8"	Der			
S58321710					WBC50232	23.8	15/16"	D/I			
RENAULT											
CAPTUR											
S10391694											
CLIO											
S10291695			BRD350210		WBC50121	17.8	45/64"	D/I			
			BRD350220 (1)						(1) con balero doble instalado		
D14828658	✓	✓	BRR350110	Sol							
			BRR350120 (1)	Sol					(1) con balero doble instalado		
D34073350	✓	✓		Sol							
D14828658	✓	✓	BRR350110	Sol							
			BRR350120 (1)	Sol					(1) con balero doble instalado		
DUSTER											
S10391694			BRD350310		WBC50327	19.0	0.0	D/I			
FLUENCE											
D34073350 (1)	✓	✓	BRR350410	Sol					(1) con freno de estacionamiento mecánico		
CMD18209056 (2)	-	✓							(2) con freno de estacionamiento de botón		
D34073350 (1)	✓	✓	BRR350410	Sol					(1) con freno de estacionamiento mecánico		
CMD18209056 (2)	-	✓							(2) con freno de estacionamiento de botón		
KANGOO											
S10281694			BRD350110		WBC50112	22.2	7/8"	D/I			
S10391694											
KANGOO MPV											
S10281694			BRD350110		WBC50112	22.2	7/8"	D/I			
KOLEOS											
D90577840	✓	✓	BRR521610	Vent							
KWID											
LAGUNA											
D94078420	✓	✓									



		2012... 2013... 2014...	EJE DELANTERO						
			PASTILLA	SM	CM	ROTOR	TIPO	CILINDRO MAESTRO	MEDIDA mm - in
RENAULT									
LOGAN									
		15-19	CMD18309061	-	✓	BFR350910	Vent		
MEGANE I									
		01-03	D11458255	✓	-	BFR350510	Vent		
MEGANE II									
	2.0L	04-10	D14958695	✓	-	BFR350510	Vent	BMC10516 23.8 15/16"	
	1.6L	07-10	D15018700	✓	-	BFR350510	Vent	BMC10516 23.8 15/16"	
CC		06-09	D14958695	✓	-	BFR350510	Vent		
OROCH									
		18->	D16278844	✓	✓	BFR350210	Vent		
SAFRANE I									
		09-11	D11458255	✓	-				
SAFRANE II									
		11-15	D11458255	✓	-				
SANDERO / STEPWAY									
		10-12	D11468256	✓	✓	BFR350610	Vent	BMC10614 20.6 13/16"	
		13-15	D11468256	✓	✓	BFR350610	Vent	BMC10614 20.6 13/16"	
		16-19	CMD18309061	-	✓	BFR350610	Vent		
RS		2017	D16278844	✓	✓				
SCALA									
		11-13	D11938311	✓	✓	BFR525110	Vent		
SCENIC I									
		01-04	D11458255	✓	-	BFR350510	Vent		
SCENIC II									
		05-08	D14958695	✓	-	BFR350510	Vent	BMC10516 23.8 15/16"	
		06-09	D15018700	✓	-			BMC10516 23.8 15/16"	
TRAFIC									
		07-14	D15008699	✓	-				
SAAB									
9-3									
Aero	L4 2.0L	05-06	D12578376	✓	-				
	V6 2.8T	2007	D12578376	✓	-			BMC10118 25.4 1"	
		2008	D97278730	✓	-			BMC10118 25.4 1"	
		2009	D12578376	✓	-			BMC10118 25.4 1"	

PASTILLA / ZAPATA		ROTOR / TAMBOR		TIPO	CILINDRO DE RUEDA	MEDIDA mm - in		I / D	
EJE TRASERO									
RENAULT									
LOGAN									
S10851734			BRD350410		WBC50292	⁽¹⁾	19.1 3/4"	D/I	⁽¹⁾ cuerpo de aluminio
S00015170	⁽²⁾								⁽²⁾ FMSI 1727 S1072
MEGANE I									
D14828658	✓	✓	BRR350110	Sol					
			BRR350120	⁽¹⁾ Sol					⁽¹⁾ con balero doble instalado
MEGANE II									
D34073350	✓	✓	BRR350210	Sol					
			BRR350220	⁽¹⁾ Sol					⁽¹⁾ con balero doble instalado
D34073350	✓	✓	BRR350210	Sol					
			BRR350220	⁽¹⁾ Sol					⁽¹⁾ con balero doble instalado
D34073350	✓	✓	BRR350210	Sol					
			BRR350220	⁽¹⁾ Sol					⁽¹⁾ con balero doble instalado
OROCH									
SAFRANE I									
SAFRANE II									
SANDERO / STEPWAY									
S00015170	⁽¹⁾		BRD350410		WBC50348	⁽²⁾	17.4 11/16"	D/I	⁽¹⁾ FMSI 1727 S1072 ⁽²⁾ de fundición
S10851734			BRD350410		WBC50292	⁽¹⁾	19.1 3/4"	D/I	⁽¹⁾ de aluminio
S10851734			BRD350410		WBC50292	⁽¹⁾	19.1 3/4"	D/I	⁽¹⁾ de aluminio
SCALA									
S10341525					WBC50343		15.8 5/8"	D/I	
SCENIC I									
D34073350	✓	✓							
SCENIC II									
D34073350	✓	✓							
D34073350	✓	✓							Encendido con tarjeta
TRAFIC									
SAAB									
9-3									
D10957957	✓	✓							
D10957957	✓	✓							
D10957957	✓	✓							
D10957957	✓	✓							



		 2012... 2013... 2014...	EJE DELANTERO						 PASTILLA				 ROTOR	TIPO	CILINDRO MAESTRO	MEDIDA mm - in
			SAAB													
9-3 cont.																
Arc		03-04	D97278730	✓	—											
		05-09	D97278730	✓	—									BMC10118	25.4	1"
Linear		03-04	D97278730	✓	—											
		05-09	D97278730	✓	—									BMC10118	25.4	1"
Vector		03-04	D97278730	✓	—											
9-5																
Aero		01-07										BFR420510	Vent			
SEAT																
ALHAMBRA																
		02-08	D88077570	✓	—							BFR375910	Vent			
ALTEA / XL																
		05-06	D11078212	✓	✓	BFR372210	Vent	BMC10425	⁽¹⁾	22.2	7/8"					
	1.4T	10-12	D11078212	✓	✓	BFR372210	Vent	BMC10425	⁽¹⁾	22.2	7/8"					
XL	1.8T	08-15	D11078212	✓	✓	BFR372210	Vent									
Freerack	2.0T	09-15	D11078212	✓	✓											
ARONA																
		18->	CMD22499485	—	✓	BFR377510	Vent									
ATECA																
		17->	CMD17608989	—	✓	BFR371910	Vent									
CORDOBA																
		01-02	D70475780	✓	—	BFR360110	Vent	BMC10134		20.6	13/16"					
	2.0L	03-09	D14378555	✓	✓	BFR371310	Vent	BMC10528	⁽¹⁾	20.6	13/16"					
	1.6L	04-09	D76876350	✓	✓	BFR371610	Vent	BMC10528	⁽¹⁾	20.6	13/16"					
EXEO																
		2011	D84077150	✓	✓											
IBIZA																
		01-02	D70475780	✓	—	BFR360110	Vent	BMC10134		20.6	13/16"					
	2.0L	03-09	D14378555	✓	✓	BFR371310	Vent	BMC10528	⁽¹⁾	20.6	13/16"					
	1.6L	04-09	D76876350	✓	✓	BFR371610	Vent	BMC10528	⁽¹⁾	20.6	13/16"					
		10-15	D11078212N	✓	✓	BFR371310	Vent	BMC10571		22.2	7/8"					
		15-17	D11078212N	✓	✓	BFR371310	Vent	BMC10615		22.2	7/8"					
		18->	CMD22499485	—	✓	BFR377510	Vent	BMC10615		22.2	7/8"					
FR Bocanegra	1.4T	11-12	D76876350	✓	✓	BFR371310	Vent									
Coupé		11-17	D11078212	✓	✓	BFR372210	Vent									
DSG		09-14	D11078212	✓	✓											
FR	1.2T	05-08	D14378555	✓	✓											
		13-17	D76876350	✓	✓	BFR371610	Vent									
	1.6L, 1.0T	18->	CMD19689193	—	✓											
LEON																
	1.8L	01-06	D76876350	✓	✓	BFR370710	Vent	BMC10449	⁽¹⁾	23.8	15/16"					
	1.8T		D5557434A	✓	✓											

PASTILLA / ZAPATA		SM CM		ROTOR / TAMBOR		TIPO	CILINDRO DE RUEDA	MEDIDA mm - in	I / D	i
SAAB										
9-3 cont.										
D10957957	✓	✓								
D10957957	✓	✓								
9-5										
SEAT										
ALHAMBRA										
D87777550	✓	-								
ALTEA / XL										
D11088213	✓	✓	BRR372010	Sol						⁽¹⁾ con cilindro original ATE
D11088213	✓	✓	BRR374710	Sol						⁽¹⁾ con cilindro original ATE
D11088213	✓	✓	BRR372010	Sol						
D11088213	✓	✓								
ARONA										
D34073350	✓	✓								
ATECA										
CMD17618990	-	✓	BRR374710	Sol						
CORDOBA										
S66214500			BRD370610		WBC50311	19.1	3/4"	D/I		
D34073350	✓	✓	BRR370510	Sol						⁽¹⁾ sin ABS
D34073350	✓	✓	BRR370110	Sol						⁽¹⁾ sin ABS
EXEO										
D11088213	✓	✓								
IBIZA										
S66214500			BRD370610		WBC50311	19.1	3/4"	D/I		
D34073350	✓	✓	BRR370510	Sol						⁽¹⁾ sin ABS
D34073350	✓	✓	BRR370110	Sol						⁽¹⁾ sin ABS
D34073350	✓	✓	BRR370510	Sol						
D34073350	✓	✓	BRR370510	Sol						
D34073350	✓	✓	BRR370510	Sol						
D34073350	✓	✓	BRR370510	Sol						
D34073350	✓	✓	BRR370510	Sol						
D34073350	✓	✓	BRR370510	Sol						
D34073350	✓	✓	BRR370510	Sol						
D34073350	✓	✓								
LEON										
D34073350	✓	✓	BRR370510	Sol						⁽¹⁾ con ESP









		 2012... 2013... 2014...	EJE DELANTERO							
			 PASTILLA			 ROTOR	TIPO	CILINDRO MAESTRO	MEDIDA mm - in	
SEAT										
LEON cont.										
		06-09	D11078212	✓	✓	BFR372210	Vent	BMC10425 ⁽¹⁾	22.2	7/8"
								BMC10426 ⁽²⁾	22.2	7/8"
Style / FR Reference		06-12	D11078212	✓	✓	BFR372210	Vent	BMC10425 ⁽¹⁾	22.2	7/8"
								BMC10426 ⁽²⁾	22.2	7/8"
		13-16	CMD17608989	—	✓	BFR372210	Vent	BMC10425 ⁽¹⁾	22.2	7/8"
								BMC10426 ⁽²⁾	22.2	7/8"
		17->	CMD17608989		✓	BFR372210	Vent			
Copa	2.0T	2013	D11078212	✓	✓	BFR376010	Vent			
Cupra R Turbo	1.8T	03-06	D5557434A	✓	✓	BFR371610	Vent	BMC10449	23.8	15/16"
		08-12	D11078212	✓	✓	BFR372210	Vent			
Cupra	2.0T	15-16				BFR376010	Vent			
		17->	CMD16338849	—	✓	BFR376010	Vent			
Style / FR / Reference		06-13	D11078212	✓	✓	BFR372210	Vent	BMC10425 ⁽¹⁾	22.2	7/8"
								BMC10426 ⁽²⁾	22.2	7/8"
		13-14	CMD17608989	—	✓	BFR372210	Vent	BMC10425 ⁽¹⁾	22.2	7/8"
								BMC10426 ⁽²⁾	22.2	7/8"
		14->	CMD17608989	—	✓	BFR372210	Vent			
ST	1.4T	16-19	CMD17608989	—	✓	BFR372210	Vent			
TARRACO										
		19->	CMD16338849	—	✓	BFR377310	Vent			
TOLEDO										
		01-05	D5557434A	✓	✓	BFR370710	Vent	BMC10449 ⁽¹⁾	23.8	15/16"
								BMC10134	20.6	13/16"
		2006	D11078212	✓	✓	BFR372210	Vent	BMC10425 ⁽¹⁾	22.2	7/8"
		2013	D11078212N	✓	✓	BFR371310	Vent	BMC10571	22.2	7/8"
		2015								
		16-19	D11078212N	✓	✓	BFR371310	Vent			
SMART										
CITY										
		2003	D12528370	✓	—					
FORTWO										
		04-15	D12528370	✓	—					
		16-18	CMD18309061	—	✓					
ROADSTER										
		04-05	D12528370	✓	—					
SUSUKI										
AERIO										
		06-07	D11958315	✓	—	BFR560110	Vent	BMC10515 ⁽¹⁾	22.2	7/8"
CIAZ										
		16->	D16148827	✓	✓	BFR560210	Vent			

EJE TRASERO								i
PASTILLA / ZAPATA	SM	CM	ROTOR / TAMBOR	TIPO	CILINDRO DE RUEDA	MEDIDA mm - in	I / D	
SEAT								
LEON cont.								
D34073350	✓	✓						(1) con cilindro original ATE (2) con cilindro original FTE
D14568656	✓	✓	BRR374710	Sol				(1) con cilindro original ATE (2) con cilindro original FTE
D14568656	✓	✓	BRR374710	Sol				(1) con cilindro original ATE (2) con cilindro original FTE
CMD17618990	—	✓	BRR374710	Sol				
D14568656	✓	✓	BRR374710	Sol				
D34073350	✓	✓						
D11088213	✓	✓						
D11088213	✓	✓						
CMD17618990	—	✓						
D14568656	✓	✓	BRR374710	Sol				(1) con cilindro original ATE (2) con cilindro original FTE
D14568656	✓	✓	BRR374710	Sol				(1) con cilindro original ATE (2) con cilindro original FTE
CMD17799008	—	✓	BRR374710	Sol				
CMD17618990	—	✓	BRR374710	Sol				
TARRACO								
CMD17618990	—	✓	BRR375410	Sol				
TOLEDO								
D34073350	✓	✓	BRR370510	Sol				(1) con ESP
D11088213	✓	✓	BRR372010	Sol				(1) con cilindro original ATE
D34073350	✓	✓	BRR370510	Sol				
					WBC50347	19.1	3/4"	D/I
D34073350	✓	✓	BRR370510	Sol				
SMART								
CITY								
FORTWO								
ROADSTER								
SUSUKI								
AERIO								
								(1) con ABS
CIAZ								





		 2012... 2013... 2014...	EJE DELANTERO							
			 PASTILLA			 ROTOR	TIPO	CILINDRO MAESTRO	MEDIDA mm - in	
SUSUKI										
ERTIGA										
		19->	CMD22729512	-	✓					
GRAND VITARA										
	L4	09-10	D11888307	✓	✓	BFR560410	Vent	BMC10607 ⁽¹⁾	23.8	15/16"
		11-17	D11888307	✓	✓	BFR560410	Vent	BMC10607 ⁽¹⁾	23.8	15/16"
	V6	06-08	D11888307	✓	✓	BFR560410	Vent	BMC10607 ⁽¹⁾	23.8	15/16"
		09-10	D11888307	✓	✓	BFR560410	Vent	BMC10607 ⁽¹⁾	23.8	15/16"
	V6 4X4	07-10	D11888307	✓	✓	BFR560410	Vent	BMC10607	23.8	15/16"
IGNIS										
		17-20	CMD20059304	-	✓					
KIZASHI										
		10-16	D13388449	✓	✓					
S-CROSS										
		14->	CMD20969331	-	✓	BFR560210	Vent			
SWIFT										
	1.5L	07-11	D16148827	✓	✓	BFR560310	Vent			
	1.4L	12-17	D16148827	✓	✓	BFR560310	Vent			
	1.2L	18->	D16148827	✓	✓	BFR560310	Vent			
Boosterjet	L3 1.0T	18->	D16148827	✓	✓	BFR560310	Vent			
Sport	1.6L	13-17	D16148827	✓	✓					
SX-4										
		08-14	D81585300	✓	✓	BFR560210	Vent			
			D81585300	✓	✓	BFR560210	Vent			
XL-7										
		07-09	D12648381	✓	✓	BFR137110	Vent			
VITARA										
		16->	CMD20969331	-	✓	BFR560210	Vent			
TOYOTA										
AVANZA										
		07-15	D14718671	✓	✓	BFR530610	Sol	BMC10540 ⁽¹⁾	22.2	7/8"
								BMC10603 ²	22.0 & 33.0	
		16->	D14718671	✓	✓	BFR531210	Vent	BMC10540 ⁽¹⁾	22.2	7/8"
								BMC10603 ⁽²⁾	22.0 & 33.0	
C-HR										
		18-19	CMD20659297	-	✓					
		2020	CMD20769311	-	✓					





EJE TRASERO									
PASTILLA / ZAPATA			ROTOR / TAMBOR	TIPO	CILINDRO DE RUEDA		MEDIDA mm - in	I / D	
SUSUKI									
ERTIGA									
GRAND VITARA									
S92116230			BRD560210		WBC50146		22.2 7/8"	lzq	(1) con ABS y ESP
D14158405	✓	✓	BRR560310	Vent					(1) con ABS y ESP
S92116230			BRD560210		WBC50146		22.2 7/8"	lzq	
D14158405	✓	✓	BRR560310	Vent					
S92116230			BRD560210		WBC50146		22.2 7/8"	lzq	
IGNIS									
KIZASHI									
D53774180	✓	✓							
S-CROSS									
CMD20079237	-	✓	BRR560610	Sol					
SWIFT									
S00015060			BRD560310						
CMD20079237	-	✓	BRR560410	Sol					
			BRR560410	Sol					
CMD20079237	-	✓							
SX-4									
D53774180	✓	✓	BRR560110	Sol					
XL-7									
D12758391	✓	✓	BRR133710	Vent					
VITARA									
CMD20079237	-	✓	BRR560610	Sol					
TOYOTA									
AVANZA									
S99716680			BRD530910		WBC50306	17.4 11/16"		lzq	(1) T/M
					WBC50307	17.4 11/16"		Der	(2) T/A
S99716680			BRD530910		WBC50306	17.4 11/16"		lzq	(1) T/M
					WBC50307	17.4 11/16"		Der	(2) T/A
C-HR									
CMD18799107	-	✓							



		2012... 2013... 2014...	EJE DELANTERO							
			PASTILLA	SM	CM	ROTOR	TIPO	CILINDRO MAESTRO	MEDIDA mm - in	
TOYOTA										
CAMRY										
LE	L4	02-04	D90877870	✓	✓	BFR530210	Vent	BMC10257	22.2	7/8"
		2005	D90678960	✓	✓	BFR530210	Vent	BMC10290 ⁽¹⁾ BMC10257 ⁽²⁾	22.2	7/8"
		2006	D90877870	✓	✓	BFR530210	Vent	BMC10290 ⁽¹⁾ BMC10257 ⁽²⁾	22.2	7/8"
		2007	D12228331	✓	✓	BFR531110	Vent	BMC10318	22.2	7/8"
		08-11	D12938331	✓	✓	BFR531110	Vent	BMC10318	22.2	7/8"
		12-17	D12938331	✓	✓	BFR531110	Vent			
		18->	CMD20769311	-	✓					
SE	V6	12-14	D12938331	✓	✓	BFR531110	Vent			
	L4	18->	CMD20769311	-	✓					
XSE	V6	15-17	D12938331	✓	✓	BFR531110	Vent			
XLE	L4, V6	2002	D90877870	✓	✓	BFR530310	Vent	BMC10257 ⁽¹⁾	22.2	7/8"
		03-05	D90877870	✓	✓	BFR530310	Vent	BMC10257 ⁽¹⁾ BMC10290 ⁽²⁾	22.2	7/8"
		2006	D90678960	✓	✓	BFR530310	Vent	BMC10257 ⁽¹⁾ BMC10290 ⁽²⁾	22.2	7/8"
	L4	2007	D12228331	✓	✓	BFR531110	Vent	BMC10318	22.2	7/8"
			D12938331	✓	✓					
	L4, V6	08-11	D12938331	✓	✓	BFR531110	Vent	BMC10318	22.2	7/8"
			D12938331	✓	✓					
L4	18->	CMD20769311	-	✓						
Híbrido		19->	CMD20769311	-	✓					
COROLLA										
/ C		14-19	D12108330	✓	✓	BFR531910	Vent	BMC10539	20.6	13/16"
		20->	CMD21769421	-	✓					
LE		03-04	D92378240	✓	✓	BFR530110	Vent	BMC10248 ⁽¹⁾ BMC10518 ⁽³⁾	20.6	13/16"
		05-08	D92378240	✓	✓	BFR530110	Vent	BMC10249 ⁽²⁾ BMC10518 ⁽³⁾	20.6	13/16"
		2009	D15718780	✓	✓	BFR530110	Vent			
		09-19	D12108330	✓	✓	BFR531910	Vent	BMC10539	20.6	13/16"
		20->	CMD21769421	-	✓					
S / S Plus		05-08	D15718780	✓	✓	BFR530110	Vent			
		14-16	D12108330	✓	✓	BFR531910	Vent	BMC10539	20.6	13/16"
SE / SE Plus		17-19	D12108330	✓	✓	BFR531910	Vent	BMC10539	20.6	13/16"
		20->	CMD21769421	-	✓					
XLE		09-13	D12158335	✓	-	BFR531910	Vent	BMC10539	20.6	13/16"
XRS		2009	D12118331	✓	✓	BFR531910	Vent	BMC10539	20.6	13/16"
		10-13	D12108330	✓	✓	BFR531910	Vent	BMC10539	20.6	13/16"
Híbrido		20->	D12108330	✓	✓	BFR532710	Vent	BMC10539	20.6	13/16"







		EJE TRASERO							
PASTILLA / ZAPATA			 ROTOR / TAMBOR	TIPO	 CILINDRO DE RUEDA	MEDIDA mm - in	I / D		
TOYOTA									
CAMRY									
									⁽¹⁾ T/A, con control de estabilidad ⁽²⁾ T/A, sin control de estabilidad
									⁽¹⁾ T/A, con control de estabilidad ⁽²⁾ T/A, sin control de estabilidad
D12128332	✓	✓	BRR530610	Sol					
D12128332	✓	✓	BRR530610	Sol					
D12128332	✓	✓	BRR530810	Sol					
D12128332	✓	✓							
D12128332	✓	✓	BRR530810	Sol					
D12128332	✓	✓							
D12128332	✓	✓	BRR530810	Sol					
D82877010	✓	—	BRR530210	Sol					⁽¹⁾ con ABS
D82877010	✓	—	BRR530210	Sol					⁽¹⁾ con ABS ⁽²⁾ con control de estabilidad
D82877010	✓	—	BRR530210	Sol					⁽¹⁾ con ABS ⁽²⁾ con control de estabilidad
D12128332	✓	✓	BRR530610	Sol					
D12128332	✓	✓	BRR530610	Sol					
D12128332	✓	✓	BRR530810	Sol					
D12128332	✓	✓							
D12128332	✓	✓							
COROLLA									
D13548463	✓	✓	BRR531310	Sol					
			BRR531310	Sol					
S80115150			BRD530110		WBC50176	19.1	3/4"	Der	⁽¹⁾ T/M
					WBC50172	19.1	3/4"	Izq	⁽³⁾ sólo unidades ensambladas en Japón
S80115150			BRD530110		WBC50176	19.1	3/4"	Der	⁽²⁾ T/A
S83215150					WBC50172	19.1	3/4"	Izq	⁽³⁾ sólo unidades ensambladas en Japón
D15728781	✓	✓	BRR531210	Sol					
D13548463	✓	✓	BRR531310	Sol					
			BRR531310	Sol					
D15728781	✓	✓	BRR531210	Sol					
D13548463	✓	✓	BRR531310	Sol					
D13548463	✓	✓	BRR531310	Sol					
			BRR531310	Sol					
D12168336	✓	—	BRR531310	Sol					
D13548463	✓	✓	BRR531310	Sol					
D13548463	✓	✓	BRR531310	Sol					
D13548463	✓	✓	BRR531310	Sol					



		 2012... 2013... 2014...	EJE DELANTERO							
			 PASTILLA	 SM	 CM	 ROTOR	TIPO	CILINDRO MAESTRO	MEDIDA mm - in	
TOYOTA										
FJ CRUISER										
		08-14	D97678770	✓	✓	BFR530410	Vent			
HIACE										
		06-15	D14348552	✓	✓	BFR531010	Vent	BMC10505	20.6 13/16"	
		14-16	D14348552	✓	✓	BFR531010	Vent			
		13-19	D14348552	✓	✓	BFR531010	Vent			
GL		20->	D22689508	✓	—	BFR532910	Vent			
Superlarga		20->	D22689508	✓	—	BFR532910	Vent			
HIGHLANDER										
		08-13	D13248436	✓	✓	BFR532210	Vent	BMC10527	22.2 7/8"	
		14->	D13248436	✓	✓	BFR532210	Vent	BMC10527	22.2 7/8"	
HILUX										
		04-05	D43672980	✓	✓					
6 barreons		06-15	D43672980	✓	✓	BFR532310	Vent	BMC10494 ⁽¹⁾	20.6 13/16"	
			D15678776	✓	✓					
		16->	D15678776	✓	✓	BFR532810	Vent			
			D97678770	✓	✓					
5 barrenos		13-15	D15238731	✓	—	BFR531810	Vent	BMC10604	20.6 13/16"	
		16->	D20589236	✓	—	BFR531810	Vent	BMC10611	22.2 7/8"	
LAND CRUISER										
		04-07	D77276390	✓	—	BFR530710	Vent			
		08-15	D13038419	✓	✓					
		16->	D13038419	✓	✓	BFR531710 ⁽¹⁾	Vent			
MATRIX										
		03-08	D92378240	✓	✓	BFR530110	Vent	BMC10248 ⁽¹⁾	20.6 13/16"	
								BMC10249 ⁽²⁾	20.6 13/16"	
		09-10	D12108330	✓	✓	BFR531910	Vent	BMC10539	20.6 13/16"	
XR	2.4L	09-10	D12118331	✓	✓	BFR531110	Vent			
MR-2										
		05-06				BFR538350	Vent			
PRIUS										
		10-15	D11848538	✓	✓					
		16-18	D11848538	✓	✓	BFR532710	Vent			
		20->								
C		18->	D11848538	✓	✓	BFR531310	Vent			
RAV-4										
	L4	04-05	D86277380	✓	—	BFR530810	Vent	BMC10280 ⁽¹⁾	20.6 13/16"	
		06-12	D12108330 ⁽¹⁾	✓	✓	BFR531510 ⁽¹⁾	Vent	BMC10436 ⁽¹⁾	20.6 13/16"	
			D12118331 ⁽²⁾	✓	✓	BFR531110 ⁽²⁾	Vent	BMC10435 ⁽²⁾	22.2 7/8"	
		03-18	D12108330 ⁽¹⁾	✓	✓	BFR531510 ⁽¹⁾	Vent	BMC10436 ⁽¹⁾	20.6 13/16"	
			D12118331	✓	✓	BFR531110	Vent	BMC10435	22.2 7/8"	







PASTILLA / ZAPATA		ROTOR / TAMBOR		TIPO	CILINDRO DE RUEDA	MEDIDA mm - in	I / D	i
TOYOTA								
FJ CRUISER								
D60674870	✓	—	BRR530110	Vent				
HIACE								
S87113580			BRD530310		WBC50297	22.2 7/8"	D/I	
S00015080			BRD531010		WBC50353	25.4 1"	D/I	
S76413970			BRD531010		WBC50353	25.4 1"	D/I	
D12818397	✓	✓						
S11151759								
HIGHLANDER								
D13258437	✓	✓	BRR530910	Sol				
D13918500	✓	✓	BRR531510	Sol				
HILUX								
S00015080			BRD536050					
S10121681			BRD530810					(1) con motor KUN25
S10121681			BRD530810					
S70917250			BRD530610		WBC50362	23.8 15/16"	D/I	
S11051750			BRD530610		WBC50362	23.8 15/16"	D/I	
LAND CRUISER								
D77376400	✓	—	BRR530310	Vent				
D13048420	✓	✓	BRR531110	Vent				
D13048420	✓	✓	BRR531110	Vent				(1) diámetro 353 mm
MATRIX								
S78515290			BRD530410		WBC50162	19.1 3/4"	D/I	(1) T/M (2) T/A
D12128332	✓	✓	BRR531310	Sol				
D13548463	✓	✓	BRR531410	Sol				
MR-2								
PRIUS								
D14238463	✓	—	BRR531310	Sol				
D14238463	✓	—	BRR531310	Sol				
RAV-4								
D10517955	✓	—	BRR530410	Sol				(1) T/A, con control de estabilidad (2) zapatas de freno de estacionamiento
			S84615760 (2)					
D12128332	✓	✓	BRR531010	Sol				(1) con dos filas de asientos (2) con tercera fila de asientos
D12128332	✓	✓	BRR531010	Sol				(1) solo LE



		 2012... 2013... 2014...		EJE DELANTERO						
				 PASTILLA			 ROTOR	TIPO	CILINDRO MAESTRO	MEDIDA mm - in
TOYOTA										
RAV-4 cont.										
	L4	19->	CMD20769311	-	✓					
	V6	09-12	D12118331	✓	✓	BFR531110	Vent	BMC10435 22.2 7/8"		
Hibrido		19->	CMD20769311	-	✓					
SEQUOIA										
		08->	D13038419	✓	✓	BFR531710	Vent	BMC10366 23.8 15/16"		
SIENNA										
		04-10	D90678960	✓	✓	BFR530310	Vent	BMC10296 19.1 3/4"		
		11-20	D13248436	✓	✓	BFR532210	Vent	BMC10527 22.2 7/8"		
SOLARA										
		05-06	D90678960	✓	✓	BFR530310	Vent			
TACOMA										
		06-08	D97678770	✓	✓	BFR530410	Vent	BMC10313 20.6 13/16"		
		09->	D97678770	✓	✓	BFR530410	Vent	BMC10434 20.6 13/16"		
TUNDRA										
		07->	D13038419	✓	✓	BFR531710	Vent	BMC10366 23.8 15/16"		
YARIS										
HB		04-05	D83177040	✓	-	BFR530910	Vent			
		06-10	D11848301	✓	✓	BFR531310	Vent	BMC10338 ⁽¹⁾ 20.6 13/16" BMC10337 ⁽²⁾ 20.6 13/16"		
		11-14	D11848301	✓	✓	BFR531310	Vent	BMC10447 20.6 13/16"		
		15-16	D11848301	✓	✓	BFR531310	Vent			
		17->	D11848301	✓	✓	BFR531310	Vent			
Sedán		14-16	D11848301	✓	✓	BFR531310	Vent	BMC10447 20.6 13/16"		
		17->	CMD19509175	-	✓	BFR531310	Vent			
R		16-20	CMD18529081	-	✓	BFR580710	Vent			
4 RUNNER										
		03-09	D97678770	✓	✓	BFR530410 ⁽¹⁾ BFR530510 ⁽²⁾	Vent Vent			
VAM										
AMERICAN										
		74-76								
		1983								
CLASSIC										
		74-76								

		EJE TRASERO							
PASTILLA / ZAPATA			TIPO		MEDIDA mm - in		I / D		
TOYOTA									
RAV-4 cont.									
D12128332	✓	✓	BRR531010	Sol					
SEQUOIA									
D13048420	✓	✓	BRR531110	Vent					
SIENNA									
D99578950	✓	✓	BRR530510	Sol				(1) zapatas de freno de estacionamiento	
			S84615760 (1)						
D13918500	✓	✓	BRR531510	Sol					
SOLARA									
D82877010	✓	-	BRR530210	Sol					
TACOMA									
S87113580			BRD530710		WBC50175	22.2 7/8"	D/I		
S87113580			BRD530710		WBC50189	23.8 15/16"	D/I		
TUNDRA									
D13048420	✓	✓	BRR531110	Vent					
YARIS									
S10301696					WBC50292	19.1 3/4"	D/I		
S91716210			BRD530510		WBC50176	19.1 3/4"	Der	(1) T/A	
					WBC50172	19.1 3/4"	lzq	(2) T/M	
S91716210			BRD530510		WBC50176	19.1 3/4"	Der	Japón	
					WBC50172	19.1 3/4"	lzq		
S10701621			BRD530510						
S10701621			BRD530510						
S10701621			BRD530510		WBC50176	19.1 3/4"	Der		
					WBC50172	19.1 3/4"	lzq		
S10701621			BRD530510						
S99114370					WBC50346	19.1 3/4"	D/I		
4 RUNNER									
D60674870	✓	-	BRR530110	Vent				(1) rin 16" (2) rin 17"	
VAM									
AMERICAN									
					WBC50126	23.8 15/16"	lzq		
					WBC50127	23.8 15/16"	Der		
					WBC50126	23.8 15/16"	lzq		
					WBC50127	23.8 15/16"	Der		
CLASSIC									
					WBC50126	23.8 15/16"	lzq		
					WBC50127	23.8 15/16"	Der		



		 2012... 2013... 2014...	EJE DELANTERO						 PASTILLA		 ROTOR		 CILINDRO MAESTRO		MEDIDA mm - in	
					TIPO											
VAM																
WAGONEER																
		70-73														
		77-80										BMC10130 ⁽¹⁾	28.5	1 1/8"		
J-174		70-73														
		74-76										BMC10130 ⁽¹⁾	28.5	1 1/8"		
VOLKSWAGEN																
AMAROK																
	L4	11->	D15558767	✓	✓	BFR376110	Vent	BMC10549	27.0	1 1/16"						
	V6	18->	CMD21969437	—	✓	BFR377110	Vent									
ATLANTIC																
		81-86	D09670310	✓	—	BFR370110	Sol	BMC10451	20.6	13/16"						
BEETLE																
	2.0L	98-99	D76877090	✓	✓	BFR370710	Vent	BMC10202	23.8	15/16"						
	2.5L	12-13	D11078212	✓	✓	BFR372210	Vent	BMC10426 ⁽¹⁾	22.2	7/8"						
		13-19	D11078212	✓	✓	BFR372210	Vent	BMC10426	22.2	7/8"						
Cabrio	2.0L	03-05	D76877090	✓	✓	BFR370710	Vent	BMC10202	23.8	15/16"						
	2.5L	05-10	D11078212	✓	✓	BFR370710	Vent	BMC10367 ⁽¹⁾	23.8	15/16"						
Dune	2.0T	16-18	D11078212	✓	✓	BFR371910	Vent	BMC10426	22.2	7/8"						
GLS		00-11	D76877090	✓	✓	BFR370710	Vent	BMC10202	23.8	15/16"						
GLS / GLX		00-05	D5557434A	✓	✓	BFR371310	Vent	BMC10202	23.8	15/16"						
Sport		06-07	D11078212	✓	✓	BFR371310	Vent	BMC10367 ⁽¹⁾	23.8	15/16"						
		08-11				BFR371310	Vent	BMC10367 ⁽¹⁾	23.8	15/16"						
		12-13	D11078212	✓	✓	BFR372210	Vent	BMC10426 ⁽¹⁾	22.2	7/8"						
		13-18	D11078212	✓	✓	BFR372210	Vent	BMC10426	22.2	7/8"						
GLX Sport	1.8T	04-05	D76877090	✓	✓	BFR371310	Vent	BMC10202	23.8	15/16"						
	2.5L	06-11				BFR371310	Vent	BMC10367 ⁽¹⁾	23.8	15/16"						
Turbo S	1.8T	02-05				BFR371310	Vent	BMC10202	23.8	15/16"						
Turbo / Turbo R	2.0T	12-15	D11078212	✓	✓	BFR371910	Vent	BMC10426	22.2	7/8"						
BORA																
		06-09	D11078212	✓	✓	BFR372210	Vent	BMC10426 ⁽¹⁾	22.2	7/8"						
		2010	D11078212	✓	✓	BFR372210	Vent	BMC10426 ⁽¹⁾	22.2	7/8"						
						BFR370710	Vent									
GLI		06-10	D11078212	✓	✓	BFR371910	Vent	BMC10426 ⁽¹⁾	22.2	7/8"						
TDI		06-10	D11078212	✓	✓	BFR372210	Vent	BMC10426 ⁽¹⁾	22.2	7/8"						
Sportwagen		2009	D11078212	✓	✓	BFR371910	Vent	BMC10426 ⁽¹⁾	22.2	7/8"						
CABRIO A3																
		96-02	D70475780	✓	—	BFR370510	Vent									

PASTILLA / ZAPATA		EJE TRASERO		ROTOR / TAMBOR		TIPO	CILINDRO DE RUEDA	MEDIDA mm - in		I / D	i
VAM											
WAGONEER											
							WBC50122	25.4	1"	Izq	
							WBC50123	25.4	1"	Der	
											⁽¹⁾ con booster
							WBC50126	23.8	15/16"	Izq	
							WBC50127	23.8	15/16"	Der	
							WBC50126	23.8	15/16"	Izq	⁽¹⁾ con booster
							WBC50127	23.8	15/16"	Der	
VOLKSWAGEN											
AMAROK											
S99616670			BRD371210				WBC50312	26.9	1 1/16"	D/I	
CMD21979438		✓	BRR375610	Sol							
ATLANTIC											
S55913540			BRD370310				WBC50230	17.4	11/16"	D/I	
			BRD370320	⁽¹⁾							⁽¹⁾ incluye baleros cónicos
BEETLE											
D34072340	✓	✓	BRR370510	Sol							
D14568656	✓	✓	BRR374710	Sol							⁽¹⁾ cilindro original FTE
D34073350	✓	✓	BRR374710	Sol							
D34073350	✓	✓	BRR370510	Sol							
D34072340	✓	✓	BRR370510	Sol							⁽¹⁾ cilindro original FTE, sin ESP
D34073350	✓	✓	BRR374710	Sol							
D34072340	✓	✓	BRR370510	Sol							
D34072340	✓	✓	BRR370510	Sol							
D11088213	✓	✓	BRR370510	Sol							⁽¹⁾ cilindro original FTE, sin ESP
D34072340	✓	✓	BRR370510	Sol							⁽¹⁾ cilindro original FTE, sin ESP
D14568656	✓	✓	BRR374710	Sol							⁽¹⁾ cilindro original FTE
D34073350	✓	✓	BRR374710	Sol							
D34072340	✓	✓	BRR370510	Sol							
D34072340	✓	✓	BRR370510	Sol							⁽¹⁾ cilindro original FTE, sin ESP
D34072340	✓	✓	BRR370510	Sol							
D14568656	⁽¹⁾	✓	✓	BRR374710	Sol						⁽¹⁾ con caliper original Bosch
D34073350	⁽²⁾	✓	✓								⁽²⁾ con caliper original TRW
BORA											
D11088213	✓	✓	BRR372010	Sol							⁽¹⁾ cilindro original FTE
D11088213	✓	✓	BRR370510	Sol							
D14568656	✓	✓	BRR374710	Sol							⁽¹⁾ cilindro original FTE
D11088213	✓	✓	BRR370910	Sol							⁽¹⁾ cilindro original FTE
D11088213	✓	✓	BRR372010	Sol							
D11088213	✓	✓	BRR370910	Sol							⁽¹⁾ cilindro original FTE
CABRIO A3											
S66214500			BRD370210				WBC50285	19.1	3/4"	D/I	
			BRD370220	⁽¹⁾							⁽¹⁾ incluye baleros cónicos



				EJE DELANTERO		TIPO	CILINDRO MAESTRO	MEDIDA mm - in		
				PASTILLA	SM					CM
VOLKSWAGEN										
CADDY										
		14-16	CMD17608989	-	✓	BFR372210	Vent			
		17->	CMD17608989	-	✓	BFR372210	Vent			
CARIBE										
		77-86	D09670310	✓	-	BFR370110	Sol	BMC10451	20.6	13/16"
GT		83-86	D28072090	✓	-	BFR370110	Sol	BMC10451	20.6	13/16"
COMBI / CARAVELLE										
		74-01	D04570210	✓	-	BFR370310	Sol	BMC10109	20.6	13/16"
CORSAR										
		85-88	D28072090	✓	-	BFR370110	Sol	BMC10451	20.6	13/16"
CRAFTER										
3.88		08-11	D13168430	✓	-	BFR343910	Vent	BMC10328 ⁽¹⁾	27.0	1 1/16"
			D13168430S ⁽³⁾	✓	-			BMC10547 ⁽²⁾		
		12-14	D13168430	✓	-	BFR343910	Vent	BMC10328 ⁽¹⁾	27.0	1 1/16"
		D13168430A ⁽³⁾	✓	-	BMC10547 ⁽²⁾			27.0		
		14-17	D16938430S ⁽¹⁾	✓	-	BFR343910	Vent			
3.5t		19->	D22479483	✓	-					
5.0		08-10	D12688383	✓	-	BFR343910	Vent	BMC10328 ⁽¹⁾	27.0	1 1/16"
			D12688383S ⁽³⁾	✓	-			BMC10547 ⁽²⁾		
		11-13	D12688383	✓	-	BFR343910	Vent	BMC10547 ⁽¹⁾	27.0	1 1/16"
		D12688383A ⁽²⁾	✓	-						
		14-17	D16998383S ⁽¹⁾	✓	-	BFR343910	Vent			
4.9t		19->	D22489484	✓	-					
CROSSFOX										
		07-17	D76876350	✓	✓	BFR371610	Vent	BMC10293	19.1	3/4"
DERBY										
		95-98	D28071830	✓	-	BFR370410	Vent	BMC10161	22.2	7/8"
			D28072090	✓	-					
		98-00	D69475690	✓	-	BFR370510	Vent	BMC10161	22.2	7/8"







PASTILLA / ZAPATA		SM CM		ROTOR / TAMBOR	TIPO	CILINDRO DE RUEDA	MEDIDA mm - in		I / D	i
VOLKSWAGEN										
CADDY										
D14568656	✓	✓		BRR374710	Sol					
CMD17799008	-	✓		BRR374710	Sol					
CARIBE										
S55913540				BRD370310 BRD370320 (1)		WBC50230	17.4	11/16"	D/I	(1) incluye baleros cónicos
S55913540				BRD370310 BRD370320 (1)		WBC50230	17.4	11/16"	D/I	(1) incluye baleros cónicos
COMBI / CARAVELLE										
				BRD370510		WBC50233	23.8	15/16"	D/I	
CORSAR										
S55913540				BRD370310 BRD370320 (1)		WBC50230	17.4	11/16"	D/I	(1) incluye baleros cónicos
CRAFTER										
D13178431	✓	-		BRR343010	Sol					(1) sistema Bosch (2) sistema TRW"
D13178431S (3)	✓	-		S93815950 (4)						(3) con 2 sensores "L" (4) zapatas de freno de estacionamiento
D13178431	✓	-		BRR343010	Sol					(1) sistema Bosch (2) sistema TRW"
D13178431A (3)	✓	-		S93815950 (4)						(3) con 2 sensores planos (4) zapatas de freno de estacionamiento
D13178431	✓	-		BRR343010	Sol					(1) con 2 sensores "L"
D13178431S (1)	✓	-		S93815950 (2)						(2) zapatas de freno de estacionamiento
CMD21979438	-	✓		BRR375610	Sol					
D13188432	✓	-		BRR342910	Vent					(1) sistema Bosch (2) sistema TRW (3) con 2 sensores "L"
D13188432S (3)	✓	-								(1) Sistema Bosch (3) con 2 sensores planos
D13188432	✓	-		BRR342910	Vent					(1) con 2 sensores "L"
D13188432A (2)	✓	-								(2) con 2 sensores planos
D13188432	✓	-		BRR342910	Vent					(1) con 2 sensores "L"
D13188432A (2)	✓	-								(2) con 2 sensores planos
D22479483	✓	-								
CROSSFOX										
S66214500				BRD370110		WBC50285	19.1	3/4"	D/I	
DERBY										
S55913540				BRD370310 BRD370320 (1)		WBC50230	17.4	11/16"	D/I	(1) incluye baleros cónicos
S55913540				BRD370310 BRD370320 (1)		WBC50285	19.1	3/4"	D/I	(1) incluye baleros cónicos



		2012... 2013... 2014...	EJE DELANTERO							
			PASTILLA	SM	CM	ROTOR	TIPO	CILINDRO MAESTRO	MEDIDA mm - in	
VOLKSWAGEN										
DERBY cont.										
		99-02	D70475780	✓	—	BFR370510	Vent	BMC10161	22.2	7/8"
		03-04	D70475780	✓	—	BFR370510	Vent	BMC10161	22.2	7/8"
		01-09	D76876350	✓	✓	BFR370510	Vent	BMC10161	22.2	7/8"
EOS										
		2010	D11078212	✓	✓	BFR371910	Vent	BMC10425	22.2	7/8"
EUROVAN										
		00-04	D85277290	✓	—	BFR371410	Sol	BMC10382 ⁽¹⁾	25.4	1"
			D8527729A ⁽²⁾	✓	—					
TDI		06-09	D11748287	✓	✓	BFR371210	Vent	BMC10349	27.0	1 1/16"
GOL										
		09-13	D6947569A	✓	✓	BFR374510	Vent	BMC10228 ⁽¹⁾	20.6	13/16"
			D15568768	✓	✓			BMC10293 ⁽²⁾	19.1	3/4"
			D16418868	✓	✓					
		13-16	D16418868	✓	✓	BFR374510	Vent	BMC10228 ⁽¹⁾	20.6	13/16"
								BMC10293 ⁽²⁾	19.1	3/4"
		17-18	D76876350	✓	✓	BFR377210	Vent			
GOLF A2 / GTI										
		87-92	D28072090	✓	—	BFR370110	Sol	BMC10484	20.6	13/16"
		89-92	D28071830	✓	—	BFR370410	Vent	BMC10484	20.6	13/16"
GOLF A3										
	1.8L	93-94	D28072090	✓	—	BFR370110	Sol	BMC10161	22.2	7/8"
		1995	D28072090	✓	—	BFR370110	Sol	BMC10134	20.6	13/16"
		1996	D69475690	✓	—	BFR370110	Sol	BMC10134	20.6	13/16"
		97-99	D69475690	✓	—	BFR370110	Sol	BMC10108	22.2	7/8"
	2.0L	93-94	D22771430	✓	—	BFR371110	Sol	BMC10161	22.2	7/8"
		95-96	D22771430	✓	—	BFR371110	Sol	BMC10134	20.6	13/16"
		97-99	D22771430	✓	—	BFR371110	Sol	BMC10108	22.2	7/8"
GTI		93-96	D22771770	✓	—	BFR370510	Vent	BMC10161	22.2	7/8"
								BMC10134	20.6	13/16"
		97-99	D22771770	✓	—	BFR370510	Vent	BMC10108	22.2	7/8"
VR6 2.8L		95-00								







PASTILLA / ZAPATA		EJE TRASERO		ROTOR / TAMBOR		TIPO	CILINDRO DE RUEDA	MEDIDA mm - in		I / D	i
SM	CM										
VOLKSWAGEN											
DERBY cont.											
S66214500			BRD370210		WBC50311		19.1	3/4"	D/I		(1) incluye baleros cónicos
			BRD370220 (1)								
S66214500			BRD370610		WBC50311		19.1	3/4"	D/I		
S66214500			BRD370610		WBC50311		19.1	3/4"	D/I		
EOS											
D11088213	✓	✓	BRR375010	Sol							
EUROVAN											
D80876850	✓	-	BRR370610	Sol							(1) con ESP y ABS (2) con un sensor
D80876810	✓	-									
D8777755B	✓	-									
D10187921	✓	✓	BRR370410	Vent							
GOL											
S66214500			BRD370210		WBC50163		17.4	11/16"	D/I		(1) sin ABS (2) con ABS (3) incluye baleros cónicos
			BRD370220 (3)								
S66214500			BRD370610		WBC50163		17.4	11/16"	D/I		
S10971743			BRD370610		WBC50365		17.4	11/16"	D/I		
GOLF A2 / GTI											
S55913540			BRD370310		WBC50230		17.4	11/16"	D/I		(1) incluye baleros cónicos
			BRD370320 (1)								
D34072340	✓	✓	BRR370110	Sol							
GOLF A3											
S66214500			BRD370210		WBC50163		17.4	11/16"	D/I		(1) incluye baleros cónicos
			BRD370220 (1)								
S66214500			BRD370210		WBC50163		17.4	11/16"	D/I		(1) incluye baleros cónicos
			BRD370220 (1)								
S66214500			BRD370210		WBC50163		17.4	11/16"	D/I		(1) incluye baleros cónicos
			BRD370220 (1)								
S66214500			BRD370210		WBC50163		17.4	11/16"	D/I		(1) incluye baleros cónicos
			BRD370220 (1)								
S66214500			BRD370210		WBC50285		19.1	3/4"	D/I		(1) incluye baleros cónicos
			BRD370220 (1)								
S66214500			BRD370210		WBC50285		19.1	3/4"	D/I		(1) incluye baleros cónicos
			BRD370220 (1)								
S66214500			BRD370210		WBC50285		19.1	3/4"	D/I		(1) incluye baleros cónicos
			BRD370220 (1)								
D34072340	✓	✓	BRR370110	Sol							
D34072340	✓	✓	BRR370110	Sol							
D34072340	✓	✓	BRR370210	Sol							



		 2012... 2013... 2014...		EJE DELANTERO						
				 PASTILLA			 ROTOR	TIPO	CILINDRO MAESTRO	MEDIDA mm - in
VOLKSWAGEN										
GOLF A4										
		00-07	D76876350	✓	✓	BFR370710	Vent	BMC10202	23.8 15/16"	
			D7687635A ⁽¹⁾	✓	✓					
GOLF A6										
	1.4T	2013	D11078212	✓	✓	BFR372210	Vent			
GOLF A7										
Comfortline, Highline		15-16	CMD17608989	—	✓	BFR372210	Vent			
		2017	CMD17608989	—	✓	BFR372210	Vent			
		18->	CMD17608989	—	✓	BFR372210	Vent			
R	2.0T	18-19	CMD16338849	—	✓	BFR376010	Vent			
GOLF SPORTWAGEN A5										
		2010	D11078212	✓	✓	BFR371910	Vent	BMC10426 ⁽¹⁾	22.2 7/8"	
		11-13	D11078212	✓	✓	BFR371910	Vent	BMC10426 ⁽¹⁾	22.2 7/8"	
		2016	CMD17608989	—	✓					
GTI										
A5		07-09	D11078212	✓	✓	BFR371910	Vent	BMC10425	22.2 7/8"	
A6		10-13	D11078212	✓	✓	BFR371910	Vent	BMC10425	22.2 7/8"	
A7		15->	CMD17608989	—	✓	BFR371910	Vent			
JETTA A2										
	1.8L	88-92	D28072090	✓	—	BFR370110	Sol	BMC10484	20.6 13/16"	
			D28071830	✓	—	BFR370410	Vent	BMC10484	20.6 13/16"	
	2.0L	90-92	D22771770	✓	—	BFR370410	Vent	BMC10484	20.6 13/16"	
JETTA A3										
	1.8L	93-95	D28072090	✓	—	BFR370110	Sol	BMC10161	22.2 7/8"	
		96-99	D69475690	✓	—	BFR370110	Sol	BMC10484	20.6 13/16"	
	2.0L	93-95	D22771430	✓	—	BFR371110	Sol	BMC10134	20.6 13/16"	
		93-97	D22771770	✓	—	BFR370510	Vent	BMC10134	20.6 13/16"	
		97-98	D22771770	✓	—	BFR370510	Vent	BMC10108	22.2 7/8"	
VR6 2.8L		97-98	D5557434A	✓	✓					
JETTA A4 / CLÁSICO										
		99-02	D76876350	✓	✓	BFR370710	Vent	BMC10202	23.8 15/16"	
			D7687635A	✓	✓					
	03-07	D76876350	✓	✓	BFR370710	Vent	BMC10367	23.8 15/16"		
		D7687635A	✓	✓						
		08-15	D76876350	✓	✓	BFR370710	Vent	BMC10367	23.8 15/16"	







PASTILLA / ZAPATA		ROTOR / TAMBOR		TIPO	CILINDRO DE RUEDA	MEDIDA mm - in		I / D	i
VOLKSWAGEN									
GOLF A4									
D34072340	✓	✓	BRR370510	Sol					(1) con sensor
GOLF A6									
D14568656	✓	✓							
GOLF A7									
CMD17799008	-	✓	BRR374710	Sol					
CMD17618990	-	✓	BRR374710	Sol					
CMD17799008	-	✓	BRR374710	Sol					
CMD17618990	-	✓							
GOLF SPORTWAGEN A5									
D11088213	✓	✓	BRR370910	Sol					(1) cilindro original FTE
D14568656	✓	✓	BRR374710	Sol					(1) cilindro original FTE
CMD17799008	-	✓							
GTI									
D11088213	✓	✓	BRR370910	Sol					
D14568656	✓	✓	BRR370910	Sol					
CMD17799008	-	✓	BRR374710	Sol					
JETTA A2									
S55913540			BRD370310 BRD370320 (1)		WBC50230	17.4	11/16"	D/I	(1) incluye baleros cónicos
D34072340	✓	✓	BRR370110 BRR370120 (1)	Sol Sol					(1) incluye baleros cónicos
D34072340	✓	✓	BRR370110 BRR370120 (1)	Sol Sol					(1) incluye baleros cónicos
JETTA A3									
S55913540			BRD370310 BRD370320 (1)		WBC50285	19.1	3/4"	D/I	(1) incluye baleros cónicos
S66214500			BRD370210 BRD370220 (1)		WBC50163	17.4	11/16"	D/I	(1) incluye baleros cónicos
S55913540			BRD370310 BRD370320 (1)		WBC50285	19.1	3/4"	D/I	(1) incluye baleros cónicos
D34072340	✓	✓	BRR370110	Sol					
D34072340	✓	✓	BRR370110	Sol					
D34072340	✓	✓	BRR370210	Sol					
JETTA A4 / CLÁSICO									
D34072340	✓	✓	BRR370510	Sol					(1) con sensor
D34072340	✓	✓	BRR370510	Sol					(1) con sensor
D34072340	✓	✓	BRR370510 (1) BRR375010 (2) BRR374710 (3)	Sol Sol Sol					(1) diámetro de 232 mm (2) diámetro de 253 mm (3) diámetro de 272 mm



		 2012... 2013... 2014...		EJE DELANTERO						 PASTILLA		   ROTOR		 CILINDRO MAESTRO		MEDIDA mm - in	
				TIPO													
VOLKSWAGEN																	
JETTA A4 / CLÁSICO cont.																	
Tambor trasero		08-15	D76876350	✓	✓	BFR370710	Vent	BMC10367	23.8	15/16"							
VR6 / Turbo	1.8T,2.8L	99-10	D5557434A	✓	✓	BFR371310	Vent	BMC10367	23.8	15/16"							
TDI		06-12	D76876350	✓	✓	BFR370710	Vent	BMC10367	23.8	15/16"							
Variant		01-03	D76877090	✓	✓	BFR370710	Vent	BMC10202	23.8	15/16"							
JETTA A6																	
		11-12	D11078212	✓	✓	BFR372210	Vent	BMC10426 ⁽¹⁾	22.2	7/8"							
	2.5L	13-18	D11078212	✓	✓	BFR372210	Vent	BMC10426 ⁽¹⁾	22.2	7/8"							
	2.0L	14-18	D7687635A	✓	✓	BFR371810	Vent										
TDI		2011	D11078212	✓	✓	BFR372210	Vent	BMC10426	22.2	7/8"							
		2012															
		13-17															
JETTA A7																	
	1.4T	19->	CMD17608989	—	✓	BFR372210	Vent										
JETTA GLI																	
		09-12	D5557434A	✓	✓	BFR371310	Vent	BMC10367	23.8	15/16"							
		12-17	D11078212	✓	✓	BFR371910	Vent	BMC10426	22.2	7/8"							
		19->	CMD17608989	—	✓	BFR371910	Vent										
LUPO																	
		05-06	D76876350	✓	✓	BFR371610	Vent	BMC10548 ⁽¹⁾	20.6	13/16"							
		07-09	D76876350	✓	✓	BFR371610	Vent	BMC10293 ⁽¹⁾	19.1	3/4"							
PASSAT																	
FWD		90-93	D22771770	✓	—	BFR370510	Vent	BMC10108	22.2	7/8"							
		1996	D5557434A	✓	✓			BMC10161	22.2	7/8"							
		1997	D5557434A	✓	✓			BMC10161	22.2	7/8"							
		99-01	D5557434A	✓	✓	BFR371710	Vent										
		01-05	D84077150	✓	✓	BFR371710	Vent	BMC10263	25.4	1"							
		06-08	D11078212 ⁽¹⁾	✓	✓	BFR371910	Vent	BMC10427	22.2	7/8"							
		09-11	D13758486	✓	✓	BFR371910	Vent	BMC10427	22.2	7/8"							
		12-14	D13758486	✓	✓	BFR371910	Vent										
		2015	D13758486	✓	✓	BFR371910	Vent										
		16-18	D13758486	✓	✓	BFR371910	Vent										
4 Motion	V6	02-05	D84077150	✓	✓	BFR371710	Vent	BMC10263	25.4	1"							
		06-08				BFR372510	Vent										
		09-12	D13758486	✓	✓	BFR371910	Vent	BMC10427	22.2	7/8"							
CC	L4	09-17	D11078212	✓	✓	BFR371910	Vent	BMC10427	22.2	7/8"							
	V6	09-11	D11078212	✓	✓	BFR372510	Vent										
		2012	CMD16338849	—	✓	BFR376010	Vent										
		13-17	CMD16338849	—	✓												







PASTILLA / ZAPATA		ROTOR / TAMBOR		TIPO	CILINDRO DE RUEDA	MEDIDA mm - in		I / D	i
SM	CM								
VOLKSWAGEN									
JETTA A4 / CLÁSICO cont.									
S99916700			BRD371010		WBC50308	20.6	13/16"	D/I	
D34072340	✓	✓	BRR370510	Sol					
D34072340	✓	✓	BRR370510	Sol					
D34072340	✓	✓	BRR370510	Sol					
JETTA A6									
D34073350	✓	✓	BRR374710	Sol					
			BRR375010	Sol					
S99916700			BRD370810		WBC50308	20.6	13/16"	D/I	⁽¹⁾ con cilindro original FTE
D34073350	✓	✓	BRR375010	Sol					⁽¹⁾ con cilindro original FTE
D34073350	✓	✓	BRR375010	Sol					
D34073350	✓	✓	BRR374710	Sol					
			BRR375010	Sol					
JETTA A7									
CMD17618990	-	✓							
JETTA GLI									
D34072340	✓	✓	BRR370510	Sol					
D34073350	✓	✓	BRR374710	Sol					
CMD17618990	-	✓	BRR375410	Sol					
LUPO									
S66214500			BRD370110		WBC50163	17.4	11/16"	D/I	⁽¹⁾ con ABS
S66214500			BRD370110		WBC50163	17.4	11/16"	D/I	⁽¹⁾ con ABS
PASSAT									
D34072340	✓	✓	BRR370110	Sol					
D34072340	✓	✓	BRR370210	Sol					
D34072340	✓	✓	BRR370210	Sol					
D34073350	✓	✓	BRR370310	Sol					
D34073350	✓	✓	BRR370310	Sol					
D11088213	✓	✓	BRR370910	Sol					⁽¹⁾ sólo L4
D14568656	✓	✓	BRR370910	Sol					
D14568656	✓	✓	BRR374710	Sol					
CMD17799008	-	✓	BRR374710	Sol					
CMD17799008	-	✓	BRR374710	Sol					
D34073350	✓	✓							
D11088213	✓	✓							
D14568656	✓	✓	BRR370910	Sol					
D11088213	✓	✓	BRR370910	Sol					
D11088213	✓	✓							
D11088213	✓	✓							
D11088213	✓	✓							



		 2012... 2013... 2014...	EJE DELANTERO							
			 PASTILLA			 ROTOR	TIPO	 CILINDRO MAESTRO	MEDIDA mm - in	
VOLKSWAGEN										
POINTER										
		98-00	D35072420	✓	—	BFR370110	Sol	BMC10107 ⁽¹⁾	20.6	13/16"
			D00013050 ⁽²⁾	✓	✓	BFR370410	Vent			
			D0001305A ⁽³⁾	✓	✓					
		00-09	D11738284	✓	✓	BFR370410	Vent	BMC10107 ⁽¹⁾	20.6	13/16"
GTI		00-03				BFR360110	Vent	BMC10107 ⁽¹⁾	20.6	13/16"
Pick Up		00-09	D11738284	✓	✓	BFR370410	Vent	BMC10107 ⁽¹⁾	20.6	13/16"
POLO										
	1.6L	03-07	D76876350	✓	✓	BFR371610	Vent	BMC10548 ⁽¹⁾	20.6	13/16"
	2.0L		D14378555	✓	✓	BFR371310	Vent	BMC10548 ⁽¹⁾	20.6	13/16"
	1.2T	13-14	D76876350	✓	✓	BFR377010	Vent	BMC10571	22.2	7/8"
	1.6L	15-20	D17769006	✓	✓	BFR377010	Vent	BMC10615	22.2	7/8"
GTI	1.4T	13-14								
ROUTAN										
		09-12	D13278481	✓	✓	BFR114810	Vent	BMC10550	25.4	1"
		12-13	D15898800	✓	✓	BFR114810	Vent	BMC10550	25.4	1"
SAVEIRO										
		10-15	D15568768	✓	✓	BFR374510	Vent	BMC10228 ⁽¹⁾	20.6	13/16"
			D16418868	✓	✓			BMC10293 ⁽²⁾	19.1	3/4"
		2016	D15568768	✓	✓	BFR374510	Vent			
			D16418868	✓	✓					
		17->	D76877090	✓	✓	BFR377210	Vent			
SEDÁN										
		66-72						BMC10128	17.5	11/16"
		73-91	S3150882A			BFD370110	Tam	BMC10128	17.5	11/16"
						BFD370120 ⁽²⁾	Tam	WBC50211 ⁽¹⁾	22.2	7/8"
		92-04	S3150882A			BFD370110	Tam	BMC10129	19.1	3/4"
						BFD370120 ⁽²⁾	Tam	WBC50211 ⁽¹⁾	22.2	7/8"
		94-04	D02107550	✓	—	BFR370910	Sol	BMC10129	19.1	3/4"
SHARAN										
		02-08	D88077570	✓	—	BFR375910	Vent			
SPORT VAN										
		07-10	D76876350	✓	✓	BFR371610	Vent	BMC10609	20.6	13/16"
T-CROSS										
		20->	CMD22499485	—	✓	BFR377510	Vent			
TIGUAN										
		09-17	D13758486	✓	✓	BFR371910	Vent			
	1.4T	18->	CMD16338849	—	✓	BFR377310	Vent			
	2.0T					BFR376010	Vent			







PASTILLA / ZAPATA		ROTOR / TAMBOR		TIPO	CILINDRO DE RUEDA	MEDIDA mm - in		I / D	i
VOLKSWAGEN									
POINTER									
S66214500			BRD370210		WBC50230	17.4	11/16"	D/I	(1) cilindro original Bosch (2) clip de 37 mm (3) clip de 43 mm
S66214500			BRD370210 BRD370220 (2)		WBC50230	17.4	11/16"	D/I	(1) cilindro original Bosch (2) incluye baleros cónicos
D69375680	✓	-							(1) cilindro Bosch
S66214500			BRD370210 BRD370220 (2)		WBC50230	17.4	11/16"	D/I	(1) cilindro original Bosch (2) incluye baleros cónicos
POLO									
S66214500			BRD370110		WBC50285 WBC50163 (2)	19.1	3/4"	D/I	(1) con ABS (2) cilindro original FTE
D34073350	✓	✓	BRR370510	Sol					
D34073350	✓	✓	BRR370510	Sol					
S81015420			BRD371110						
D34073350	✓	✓	BRR370510	Sol					
ROUTAN									
D13268438	✓	✓	BRR112910	Sol					
D15968811	✓	✓	BRR112910	Sol					
SAVEIRO									
S99916700			BRD370910		WBC50311 WBC50308	19.1	3/4"	D/I	(1) sin ABS (2) con ABS
D34073350	✓	✓	BRR375810	Sol					
D34073350	✓	✓	BRR375810	Sol					
SEDÁN									
					WBC50212	19.1	3/4"	D/I	
S3150882A			BRD370410		WBC50213	17.4	11/16"	D/I	(1) cilindro de rueda delantero (2) incluye baleros cónicos
S3150882A			BRD370410		WBC50213	17.4	11/16"	D/I	(1) cilindro de rueda delantero (2) incluye baleros cónicos
S3150882A			BRD370410						
SHARAN									
D8777755B (1)	✓	-							(1) con un sensor
D87777550 (2)	✓	-							(2) con dos sensores
SPORT VAN									
S66214500			BRD370110		WBC50285	19.1	3/4"	D/I	
T-CROSS									
TIGUAN									
D11088213	✓	✓	BRR370910	Sol					
CMD17618990	-	✓	BRR375410	Sol					



		 2012... 2013... 2014...	EJE DELANTERO						 PASTILLA		 ROTOR		 CILINDRO MAESTRO		MEDIDA mm - in	
					TIPO											
VOLKSWAGEN																
TOUAREG																
		04-05								BMC10349	27.0	1 1/16"				
		06-17														
TDI		07-18														
TRANSPORTER																
		10->	D11748287	✓	✓	BFR371210	Vent									
UP																
		16-18	D16418868	✓	✓	BFR374510	Vent									
VAN																
		03-09	D22771770	✓	-	BFR370510	Vent	BMC10161	22.2	7/8"						
			D11738284	✓	✓	BFR370410	Vent	BMC10107	20.6	13/16"						
VENTO																
		14-16	D17769006	✓	✓	BFR377010	Vent	BMC10571	22.2	7/8"						
		14->	D17769006	✓	✓	BFR377010	Vent	BMC10615	22.2	7/8"						
VIRTUS																
		20->	D76876350	✓	✓	BFR377610	Vent									
VOLVO																
C30																
		08-13	D10447947	✓	✓	BFR410410	Vent									
C70																
Coupé	Rin 17"	99-03	D84077150	✓	✓											
Cabrio	Rin 17"	00-05	D84077150	✓	✓											
						BFR410710	Vent									
		07-09	D10447947	✓	✓	BFR410410	Vent									
		10-13	D10447947	✓	✓	BFR410410	Vent									
S40																
		05-11	D10447947	✓	✓	BFR410410	Vent									
T5	2.5T	04-12				BFR410710	Vent									
S60																
		01-08														
S80																
L5	2.5L AWD	05-06														
L6		99-06														
V40																
		14-19	D10447947	✓	✓											
Cross Country		14-18	D10447947	✓	✓											
V50																
		2005	D10447947	✓	✓	BFR410710	Vent									
		06-07	D10447947	✓	✓	BFR410710	Vent									

PASTILLA / ZAPATA		EJE TRASERO		ROTOR / TAMBOR		TIPO	CILINDRO DE RUEDA	MEDIDA mm - in	I / D	i
SM	CM									
VOLKSWAGEN										
TOUAREG										
				BRR373210	Vent					
				BRR373210	Vent					
				BRR373210	Vent					
TRANSPORTER										
D10187921	✓	✓		BRR370410	Vent					
UP										
S10971743							WBC50365	17.4 11/16"	D/I	
VAN										
S99916700				BRD370910			WBC50163	17.4 11/16"	D/I	(1) incluye baleros cónicos
S66214500				BRD370210						
				BRD370220 (1)						
VENTO										
S81015420				BRD371110			WBC50347	19.1 3/4"	D/I	
S81015420				BRD371110			WBC50347	19.1 3/4"	D/I	
VIRTUS										
VOLVO										
C30										
D10957957	✓	✓		BRR410410	Sol					
C70										
D10957957	✓	✓		BRR410410	Sol					
D10957957	✓	✓		BRR410410	Sol					
S40										
D10957957	✓	✓		BRR410410	Sol					
D10957957	✓	✓		BRR410410	Sol					
S60										
D79576650	✓	-								
S80										
D79576650	✓	-								
D79576650	✓	-								
V40										
D10957957	✓	✓								
D10957957	✓	✓								
V50										
				BRR410410	Sol					
D10957957	✓	✓		BRR410410	Sol					



		 2012... 2013... 2014...	EJE DELANTERO						 PASTILLA		 ROTOR		 CILINDRO MAESTRO		MEDIDA mm - in	
					TIPO											
VOLVO																
V70																
T5		01-03														
XC70																
		01-07														
XC90																
	L5 2.5T	05-07	D10037904	✓	—											
AUTOS DE PROCEDENCIA EXTRANJERA																
CHEVROLET																
ASTRO																
		85-86														
		90-95									BMC10102	⁽¹⁾	28.6	& 40.0		
		96-03									BMC10171		31.7	1 1/4"		
BLAZER																
		82-88								BFR130410	Vent					
CAVALIER																
		90-91														
EXPRESS																
"15 Pasajeros Cargo Van 3500"		03-07	D78476520	✓	✓						BMC10345	⁽²⁾	37.0	0.0		
NOVA																
		85-88														
S10																
		82-88	D1547070A	✓	—					BFR130410	Vent					
SILVERADO 1500 4X4																
Crew Cab	6.0L	2007	D10927997	✓	✓					BFR137310	Vent					
SUBURBAN 2500																
		00-02	D78476520	✓	✓					BFR136210	Vent	BMC10216		37.0	0.0	
CHRYSLER																
CIRRUS																
		01-06	D86977440	✓	✓					BFR110410	Vent	BMC10274		23.8	15/16"	
SEBRING																
	L4	05-06	D86977440	✓	✓					BFR110410	Vent	BMC10274		23.8	15/16"	
TOWN & COUNTRY AWD																
		91-95	D5217403A	✓	—					BFR110910	Vent					
			D5227404A	✓	—						BFR112610	Vent				
VOYAGER / GRAND VOYAGER AWD																
		91-95	D5217403A	✓	—					BFR110910	Vent					
			D5227404A	✓	—						BFR112610	Vent				

PASTILLA / ZAPATA		ROTOR / TAMBOR		TIPO	CILINDRO DE RUEDA	MEDIDA mm - in	I / D	i
VOLVO								
V70								
D79576650	✓	—						
XC70								
D79576650	✓	—						
XC90								
AUTOS DE PROCEDENCIA EXTRANJERA								
CHEVROLET								
ASTRO								
					WBC50275	20.6 13/16"	D/I	
								(1) con ABS en ruedas traseras
BLAZER								
					WBC50246	22.2 7/8"	D/I	
CAVALIER								
S55321640			BRD130310		WBC50254	15.8 5/8"	D/I	
EXPRESS								
D97478750	✓	✓	BRR132510 (1)	Vent				(1) altura total de 91 mm (2) con rodada sencilla y StabiliTrak(R)
NOVA								
					WBC50315	17.4 11/16"	Der	
					WBC50316	17.4 11/16"	Izq	
S10								
					WBC50246	22.2 7/8"	D/I	
SILVERADO 1500 4X4								
S85515830			BRD133210		WBC50187 (1)	26.9 1 1/16"	D/I	(1) 7000 lb PBV
SUBURBAN 2500								
D78576530	✓	✓	BRR132510	Vent				
CHRYSLER								
CIRRUS								
					WBC50160	19.1 3/4"	D/I	
SEBRING								
					WBC50160	19.1 3/4"	D/I	
TOWN & COUNTRY AWD								
					WBC50273	19.1 3/4"	D/I	
			BRD111910 (1)					(1) altura total de 108 mm
VOYAGER / GRAND VOYAGER AWD								
S53821680			BRD111910 (1)		WBC50273	19.1 3/4"	D/I	(1) altura total de 108 mm



		 2012... 2013... 2014...	EJE DELANTERO						 CILINDRO MAESTRO		MEDIDA mm - in	
			 PASTILLA			 ROTOR	TIPO					
DODGE												
CARAVAN												
	AWD	91-95	D5217403A	✓	—	BFR110910	Vent					
			D5227404A	✓	—	BFR112610	Vent					
D50												
		83-86										
RAM 50												
		87-93										
STRATUS												
SE / LE	2 discos	04-06				BFR110410	Vent	BMC10274	23.8	15/16"		
FORD												
AEROSTAR												
		86-89				BFR122810	Vent	BMC10477	23.8	15/16"		
						BFR122820	Vent					
BRONCO												
		78-86						BMC10136	25.4	1"		
BRONCO II												
		83-89	D2497125A	✓	—	BFR123310	Vent	BMC10471	23.8	15/16"		
	2WD	1990	D2497125A	✓	—	BFR123310	Vent	BMC10471	23.8	15/16"		
	4WD					BFR123410	Vent					
E-150 / ECONOLINE 150												
		77-86				BFR126410	Vent	BMC10136	25.4	1"		
EXPLORER												
Sport TRACK		01-02	D83377060	✓	✓	BFR128010	Vent					
						BFR121010	Vent					
F-150												
		80-83	D0507013A	✓	—	BFR126410	Vent	BMC10136	25.4	1"		
F-250												
SUPER DUTY		05-06	D10697974	✓	✓			BMC10309	38.1	1 1/2"		
								BMC10310	33.3	1 5/16"		
		07-08	D10697974	✓	✓			BMC10409	33.3	1 5/16"		
F-350												
		82-83	D12070540	✓	—	BFR122510	Vent	BMC10452	27.0	1 1/16"		
		83-86	D12070540	✓	—	BFR122510	Vent	BMC10464	28.5	1 1/8"		
		87-90	D12070540	✓	—	BFR122510	Vent	BMC10479	28.5	1 1/8"		
		91-92	D12070540	✓	—	BFR122510	Vent	BMC10480	28.5	1 1/8"		







PASTILLA / ZAPATA		EJE TRASERO		ROTOR / TAMBOR		TIPO	CILINDRO DE RUEDA	MEDIDA mm - in		I / D	i
SM	CM										
DODGE											
CARAVAN											
							WBC50273	19.1	3/4"	D/I	
						BRD111910					
D50											
							WBC50321	20.6	13/16"	Der	
							WBC50322	20.6	13/16"	Izq	
RAM 50											
							WBC50325	23.8	15/16"	Der	
STRATUS											
							WBC50160	19.1	3/4"	D/I	
FORD											
AEROSTAR											
							WBC50248	20.6	13/16"	D/I	(1) incluye baleros cónicos
BRONCO											
BRONCO II											
											(1) 2WD
E-150 / ECONOLINE 150											
EXPLORER											
							WBC50152	22.2	7/8"	Izq	(1) 2WD
							WBC50153	22.2	7/8"	Der	(2) 4WD
F-150											
F-250											
D10687973	✓	-									(1) Diesel, con booster hidráulico y control de freno integral (2) sin control de freno integral
D10687973	✓	-									
D10677973	✓	✓									(1) sin control de freno integral
F-350											
							WBC50214	25.4	1"	Izq	
							WBC50215	25.4	1"	Der	
							WBC50214	25.4	1"	Izq	
							WBC50215	25.4	1"	Der	
							WBC50214	25.4	1"	Izq	
							WBC50215	25.4	1"	Der	
S58321710							WBC50214	25.4	1"	Izq	
							WBC50215	25.4	1"	Der	



		 2012... 2013... 2014...	EJE DELANTERO							
			 PASTILLA			 ROTOR	TIPO	 CILINDRO MAESTRO	MEDIDA mm - in	
FORD										
FOCUS										
		05-07	D13398450	✓	—					
MONDEO										
		01-07	D91077890	✓	✓	BFR126910	Vent	BMC10316 ⁽¹⁾	23.8	15/16"
RANGER										
		86-90				BFR122810 ⁽¹⁾	Vent	BMC10471	23.8	15/16"
		90-94								
TRANSIT										
Gasolina / Electrica	2.0L	07-14	D15288736N	✓	✓	BFR221810	Vent	BMC10431 ⁽¹⁾	23.8	15/16"
			D15288736 ⁽²⁾	✓	✓	BFR220710	Vent			
WINDSTAR										
		99-03	D80376740	✓	—	BFR126710	Vent			
GMC										
JIMMY										
		82-88	D1547070A	✓	—	BFR130410	Vent			
SAFARI										
		85-86	D0520728A	✓	—					
		90-92	D0520728A	✓	—			BMC10102 ⁽¹⁾	28.6	& 40.0
		93-95	D0520728A	✓	—			BMC10102 ⁽¹⁾	28.6	& 40.0
			D36972590 ⁽²⁾	✓	—					
		96-00	D0520728A	✓	—			BMC10171	31.7	1 1/4"
			D36972590 ⁽¹⁾	✓	—					
SIERRA										
		07-08	D10927997	✓	✓	BFR137310	Vent			
SONOMA										
		81-88								
HONDA										
ACCORD L4										
EX / EX-R		98-02	D46575730	✓	✓	BFR510310	Vent			
		03-07	D91477950	✓	✓	BFR510410	Vent	BMC10537	15.8	5/8"
CIVIC Sedán										
DEL SOL		93-97				BFR510210 ⁽¹⁾	Vent	BMC10487	20.6	13/16"
						BFR511010 ⁽²⁾	Vent			
Sedán	DX, LX	88-95				BFR510210	Vent	BMC10487	20.6	13/16"
	EX					BFR511010	Vent			
CRX										
		88-89						BMC10487	20.6	13/16"
DX 1.5L		90-91				BFR510210	Vent	BMC10487	20.6	13/16"

EJE TRASERO								i
PASTILLA / ZAPATA	SM	CM	ROTOR / TAMBOR	TIPO	CILINDRO DE RUEDA	MEDIDA mm - in	I / D	
FORD								
FOCUS								
MONDEO								
D91177900	✓	✓	BRR121510	Sol				(1) con control de tracción
D10717976 (2)	✓	—						(2) sólo algunos 05-07
RANGER								
					WBC50248	20.6 13/16"	D/I	(1) 2WD
					WBC50248	20.6 13/16"	D/I	
TRANSIT								
D15028701N	✓	✓	BRR125810	Sol				(1) sin depósito
D15028701 (2)	✓	✓	BRR124410	Sol				(2) con cable sensor
WINDSTAR								
S66514520								(1) sin control de tracción
GMC								
JIMMY								
					WBC50246	22.2 7/8"	D/I	
SAFARI								
					WBC50275	20.6 13/16"	D/I	
								(1) ABS en eje trasero
								(1) ABS en eje trasero (2) 4WD
								(1) 4WD
SIERRA								
S85515830			BRD133210		WBC50187 (1)	26.9 1 1/16"	D/I	(1) 7000 lb PBV
SONOMA								
					WBC50246	22.2 7/8"	D/I	
HONDA								
ACCORD L4								
					WBC50271	20.6 13/16"	Izq	
					WBC50272	20.6 13/16"	Der	(1) sin ABS
					WBC50165	20.6 13/16"	Izq	
					WBC50166	20.6 13/16"	Der	
CIVIC Sedán								
								(1) sin ABS (2) con ABS
			BRD510110					
CRX								



		 2012... 2013... 2014...	EJE DELANTERO						 PASTILLA			 ROTOR	TIPO	 CILINDRO MAESTRO	MEDIDA mm - in
HYUNDAI															
ELANTRA															
		01-09													
MAZDA															
B-2000															
		86-87													
B-2200															
		86-93													
B-2300															
	2WD	1994				BFR122810	Vent								
	4WD					BFR123310	Vent								
B-2600															
		86-93													
B-3000 / B-4000															
		1994				BFR122810	Vent								
MITSUBISHI															
MONTERO															
Sport		97-98													
		99-03													
NISSAN															
FRONTIER															
	L4	99-00	D33372280	✓	—	BFR523010	Vent	BMC10121 ⁽¹⁾	25.4	1"					
	V6	99-00	D33372280	✓	—	BFR523210	Vent	BMC10121 ⁽¹⁾	25.4	1"					
PICK UP															
		81-84	D26571700	✓	—			BMC10124	22.2	7/8"					
		85-88	D33372280	✓	—			BMC10124	22.2	7/8"					
PEUGEOT															
306															
		97-02				BFR380210	Vent								
SUZUKI															
SWIFT															
2 puertas		89-96													
TOYOTA															
HILUX															
		06-15	D43672980	✓	✓	BFR532310	Vent	BMC10517 ⁽¹⁾	20.6	13/16"					
			D97678770	✓	✓										
			D15678776	✓	✓										
4 RUNNER															
		87-02													

PASTILLA / ZAPATA		SM CM		ROTOR / TAMBOR		TIPO	CILINDRO DE RUEDA	MEDIDA mm - in		I / D	i
HYUNDAI											
ELANTRA											
							WBC50320	19.1	3/4"	D/I	
MAZDA											
B-2000											
							WBC50256	19.1	3/4"	Der	
							WBC50255	19.1	3/4"	Izq	
B-2200											
							WBC50256	19.1	3/4"	Der	
							WBC50255	19.1	3/4"	Izq	
B-2300											
							WBC50248	20.6	13/16"	D/I	
B-2600											
							WBC50256	19.1	3/4"	Der	
							WBC50255	19.1	3/4"	Izq	
B-3000 / B-4000											
							WBC50248	20.6	13/16"	D/I	
MITSUBISHI											
MONTERO											
							WBC50324 ⁽¹⁾	23.8	15/16"	D/I	
							WBC50323 ⁽¹⁾	22.2	7/8"	D/I	
NISSAN											
FRONTIER											
S57413990											⁽¹⁾ Standard Cab
S57413990				BRD520710							⁽¹⁾ Standard Cab
PICK UP											
PEUGEOT											
306											
							WBC50304	20.6	13/16"	Izq	
							WBC50303	20.6	13/16"	Der	
SUZUKI											
SWIFT											
							WBC50319	15.8	5/8"	D/I	
TOYOTA											
HILUX											
S10121681				BRD530810							⁽¹⁾ T/A
4 RUNNER											
							WBC50262	22.2	7/8"	D/I	



		2012... 2013... 2014...	EJE DELANTERO						MEDIDA mm - in
			PASTILLA	SM	CM	ROTOR	TIPO	CILINDRO MAESTRO	
TOYOTA									
PICK UP									
		79-93							
		95-04							
PREVIA									
		91-97							
TACOMA									
		06-08	D97678770	✓	✓	BFR530410	Vent	BMC10314 ⁽¹⁾ 20.6 13/16"	
DINA									
1000									
		75-76						BMC10130 28.5 1 1/8"	
		80-81						BMC10130 28.5 1 1/8"	
		81-83						BMC10454 28.6 & 40.0	
3000									
		75-80							
		80-83						BMC10454 28.6 & 40.0	
3200									
		80-83						BMC10454 28.6 & 40.0	
FREIGHTLINER									
514			D78676540	✓	-				
		07-18	D12658382	✓	-				
FOTON									
2000									
		10-17	D17008924	✓	-				
HINO									
SERIE 300 EURO IV									
414	4,300	09-11	D15508759	✓	-				
514	4,500	12->	D15508759	✓	-				
614	5,500	10-11	D15508759	✓	-				
616	5,500	12->	D15508759	✓	-				
716	6,500	09-10	D82576970	✓	-				
		11->	D82576970	✓	-				
816	7,250	09-10	D82576970	✓	-				
		11->	D82576970	✓	-				
SERIE 300 EURO V									
514	4,500	19->	D15508759	✓	-				
616	5,500	19->	D15508759	✓	-				

EJE TRASERO								i
PASTILLA / ZAPATA	SM	CM	ROTOR / TAMBOR	TIPO	CILINDRO DE RUEDA	MEDIDA mm - in	I / D	
TOYOTA								
PICK UP								
					WBC50237	23.8 15/16"	D/I	
					WBC50262	(1) 22.2 7/8"	D/I	(1) 4WD
					WBC50139	(2) 23.8 15/16"	D/I	(2) 2WD
PREVIA								
					WBC50318	22.2 7/8"	D/I	
TACOMA								
S87113580			BRD530710					(1) con T/M, sin control de estabilidad
DINA								
1000								
3000								
					WBC50126	23.8 15/16"	Izq	
					WBC50127	23.8 15/16"	Der	
3200								
FREIGHTLINER								
D78676540	✓	-						
D12658382	✓	-						D12658382 Juegos de 8 piezas
FOTON								
2000								
HINO								
SERIE 300 EURO IV								
D82676980	✓	-						
D82676980	✓	-						
SERIE 300 EURO V								





		2012... 2013... 2014...	EJE DELANTERO				TIPO	CILINDRO MAESTRO	MEDIDA mm - in
			PASTILLA	SM	CM	ROTOR			
HINO									
SERIE 300 EURO V cont.									
716	6,500	19->	D82576970	✓	-				
816	7,500	19->	D82576970	✓	-				
INTERNACIONAL									
CF-500 / CF-600									
		06-14	D77776440	✓	-	BFR220410	Vent		
ISUZU									
ELF 200									
4.1 TONELADAS		09->	D17008924	✓	-				
ELF 300									
5.2 TONELADAS		07->	D82676980 D82576970	✓ ✓ -	- - -	BFR590110	Vent		
ELF 400									
6.6 TONELADAS		07->	D82576970	✓	-				
ELF 450									
5.2 TONELADAS		07-08	D82776990	✓	-				
ELF 500									
7.257 TONELADAS		09->	D82776990	✓	-				
ELF 600									
8.865 TONELADAS		09->	D82776990	✓	-				
ELF 600 BUS									
8.0 TONELADAS		10->	D82776990	✓	-				
HIGER									
Plataforma de 9 y 12 metros									
		20->	D00014050	✓	-				
NISSAN COMERCIALES									
CABSTAR									
Corta		08-14	D15818793	✓	-				
Larga		08-18	D16228834	✓	-		BMC10552	27.0	1 1/16"
RENAULT CV									
MASCOT									
		07-09	D16228834	✓	-				
STERLING									
360									
		04-14	D12658382	✓	-				

EJE TRASERO										i
PASTILLA / ZAPATA	SM	CM	ROTOR / TAMBOR	TIPO	CILINDRO DE RUEDA		MEDIDA mm - in	I / D		
HINO										
SERIE 300 EURO V cont.										
D82676980	✓	—								
D82676980	✓	—								
INTERNATIONAL										
CF-500 / CF-600										
D77776440	✓	—								
ISUZU										
ELF 200										
ELF 300										
S72614170					WBC50340	⁽²⁾	25.4	1"	Izq	⁽¹⁾ rueda izq, lado Izq / der
					WBC50341	⁽³⁾	25.4	1"	Der	⁽²⁾ rueda der, lado izquierdo
					WBC50342	⁽⁴⁾	25.4	1"	Der	⁽³⁾ rueda der, lado derecho
ELF 400										
S69914820					WBC50314	⁽²⁾	30.1	1 3/16"	Izq	⁽¹⁾ rueda izq, lado derecho
					WBC50336	⁽³⁾	30.1	1 3/16"	Izq	⁽²⁾ rueda izq, lado izquierdo
					WBC50313	⁽⁴⁾	30.1	1 3/16"	Der	⁽³⁾ rueda der, lado izquierdo
					WBC50337	⁽⁵⁾	30.1	1 3/16"	Der	⁽⁴⁾ rueda der, lado derecho
ELF 450										
S79215340										
ELF 500										
ELF 600										
ELF 600 BUS										
HIGER										
Plataforma de 9 y 12 metros										
D00014050	✓	—								KLQ6935GC / KLQ6129GWC
NISSAN COMERCIALES										
CABSTAR										
D15828794	✓	—								
D14878687	✓	—								
RENAULT CV										
MASCOT										
D14878687	✓	—								
STERLING										
360										

CALIDAD.

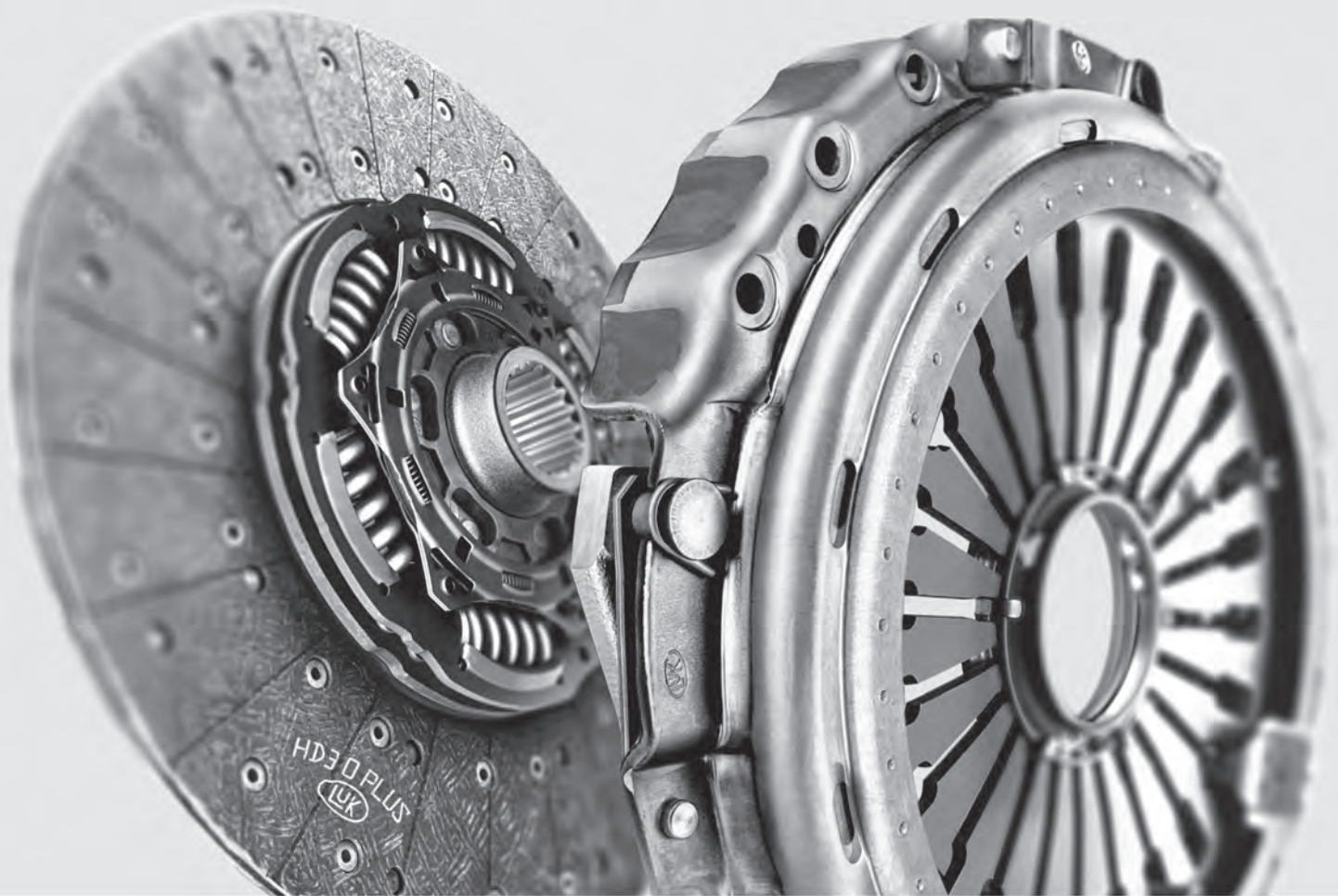

Embragues para Carga y Pasaje
Soluciones Alemanas en calidad de EO.

SCHAEFFLER

D02107550	D04570210	D0507013A
<p>56.0 53.0 15.0 Int./Ext. X 4</p>	<p>76.5 69.8 19.1 Int./Ext. X 4</p>	<p>157.4 58.4 17.1 Int. X 2 63.0 Ext. X 2 14.4</p>
D0520728A	D08670190	D09670310
<p>184.0 65.5 15.9 Int. X 2 61.1 Ext. X 2 13.6</p>	<p>165.2 63.3 17.3 Int. X 2 61.1 Ext. X 2 12.7</p>	<p>61.5 56.9 18.4 Int./Ext. X 4</p>
D12070540	D14970810	D1547070A
<p>194.0 69.5 16.6 Int./Ext. X 2 70.2 Int./Ext. X 2</p>	<p>182.8 65.3 20.1 Int. X 2 70.2 Ext. X 2 15.7</p>	<p>152.5 72.0 15.7 Int. X 1 67.5 Ext. X 2 13.5</p>
D21571360	D2207134A	D22471410
<p>128.4 69.1 16.0 Int. X 2 56.7 Ext. X 2 11.6</p>	<p>151.0 51.7 16.1 Int. X 2 Ext. X 2 16.1</p>	<p>213.4 100.0 18.9 Int./Ext. X 4</p>
D22771430	D22771770	D23371550
<p>119.5 69.6 19.2 Int./Ext. X 4</p>	<p>119.5 69.6 15.2 Int./Ext. X 4</p>	<p>108.3 40.4 15.6 Int./Ext. X 4</p>



<p>D2497125A</p> <p>159.9 62.5 Int. X 2 172.0 62.6 Ext. X 2 15.1 14.4</p>	<p>D2577106A</p> <p>164.0 45.4 Int. X 2 Ext. X 1 17.1 17.1 Ext. X 1</p>	<p>D26571700</p> <p>129.8 48.9 Int./Ext. X 4 17.0</p>
<p>D2697179A</p> <p>165.2 63.3 Int. X 2 17.3 17.3 61.1 Ext. X 2 12.7</p>	<p>D28071830</p> <p>137.8 51.2 Int. X 2 15.3 15.3 49.0 Ext. X 2</p>	<p>D28072090</p> <p>137.8 51.2 Int. X 2 19.7 19.7 49.0 Ext. X 2</p>
<p>D33372280</p> <p>160.5 50.0 Ext. X 4 17.0 17.0 Int. X 1 17.0 Int. X 1</p>	<p>D34072340</p> <p>87.2 53.0 Int./Ext. X 4 14.9 14.9</p>	<p>D34073350</p> <p>87.2 53.0 Int./Ext. X 4 16.8 16.8</p>
<p>D34972410</p> <p>127.8 56.6 Int. X 2 16.3 16.3 16.3 Ext. X 2</p>	<p>D35072420</p> <p>151.3 49.0 Int. X 2 19.3 19.3 19.3 Ext. X 2</p>	<p>D36373470</p> <p>127.0 50.6 Int./Ext. X 4 15.5 15.5 15.5</p>
<p>D36872590</p> <p>125.6 72.3 Int. X 2 16.6 16.6 147.9 58.7 Ext. X 2 15.7</p>	<p>D36972590</p> <p>125.6 76.5 Int. X 2 16.6 16.6 147.9 58.7 Ext. X 2 15.7</p>	<p>D37072600</p> <p>125.0 85.6 Int. X 2 17.0 17.0 147.2 58.9 Ext. X 1 15.7 15.7 Ext. X 1</p>

© Schaeffler Automotive Aftermarket México S. de R.L. de C.V. se reserva todos y cada uno de los derechos sobre las fotografías exclusivas de la marca aquí presentadas; se prohíbe la reproducción parcial y/o total, uso, modificación y distribución de cada una de estas fotografías

<p>D38078150</p> <p>Int. X 2 Ext. X 2</p>	<p>D39672860</p> <p>Int. X 2 Ext. X 2</p>	<p>D40472930</p> <p>Int. X 2 Ext. X 2</p>
<p>D43073180</p> <p>Int. X 1 Ext. X 2</p>	<p>D43672980</p> <p>Int. X 2 Ext. X 1</p>	<p>D45973390</p> <p>Int. X 2 Ext. X 1</p>
<p>D4597339A</p> <p>Int. X 2 Ext. X 1</p>	<p>D46573450</p> <p>Int. X 1 Ext. X 2</p>	<p>D46575730</p> <p>Int. X 1 Ext. X 2</p>
<p>D46672190</p> <p>Int. X 1 Ext. X 2</p>	<p>D47373530</p> <p>Int. X 1 Ext. X 2</p>	<p>D4777507A</p> <p>Int. X 1 Ext. X 1</p>
<p>D48573420</p> <p>Int. X 2 Ext. X 2</p>	<p>D50373820</p> <p>Int. X 1 Ext. X 2</p>	<p>D50673850</p> <p>Int. X 2 Ext. X 1</p>



D51073890	D5217403A	D5227404A
D53074120	D53674180	D53774180
D54074210	D5557434A	D55674350
D55874370	D56474430	D57674560
D5917470A	D60174790	D60674870



<p>D6257502A</p>	<p>D62775040</p>	<p>D63275030</p>
<p>D6417438B</p>	<p>D6427518A</p>	<p>D64975290</p>
<p>D6507530A</p>	<p>D65275320</p>	<p>D65373180</p>
<p>D65575350</p>	<p>D6587438A</p>	<p>D66375140</p>
<p>D66475430</p>	<p>D6667502A</p>	<p>D6677545A</p>



D66875460	D67375540	D67975580
D68073480	D68374270	D68875630
D69175660	D69375680	D69475690
D6947569A	D69975740	D70275760
D70475780	D71075830	D71175840



<p>D72374120</p>	<p>D72575920</p>	<p>D72675930</p>
<p>D72775940</p>	<p>D72975960</p>	<p>D73075970</p>
<p>D74876170</p>	<p>D75676250</p>	<p>D75776260</p>
<p>D75876270</p>	<p>D76076280</p>	<p>D76376310</p>
<p>D76876350</p>	<p>D7687635A</p>	<p>D76877090</p>



D77276390	D77376400	D77776440
<p>119.3 77.9 Int./Ext. X 2 17.3 Int./Ext. X 2 17.0</p>	<p>123.0 45.0 Int./Ext. X 4 17.0</p>	<p>221.7 64.6 Int./Ext. X 4 20.7 17.0</p>
D78178470	D78476520	D78576530
<p>150.2 57.5 Int. X 2 17.5 151.4 Ext. X 2</p>	<p>216.0 67.0 Int. X 1 18.7 17.0 Int. X 1 Ext. X 2</p>	<p>176.8 59.2 Int. X 1 18.8 17.0 Int. X 1 Ext. X 2</p>
D78676540	D78776560	D78976590
<p>244.1 86.1 Int. / Ext. X 4 20.3 17.0</p>	<p>149.1 58.7 Int. X 2 17.3 17.0 Ext. X 2</p>	<p>125.3 76.0 Int. X 2 16.6 147.9 58.7 Ext. X 2 15.7</p>
D79076600	D79176610	D79276620
<p>192.3 55.4 Int. X 2 17.8 194.4 Ext. X 1 Ext. X 1</p>	<p>139.4 55.3 Int. X 2 16.8 141.4 59.2 Ext. X 2</p>	<p>142.5 51.6 Int./Ext. X 4 17.1 17.0</p>
D79376630	D79576650	D80276730
<p>139.1 55.2 Int./Ext. X 4 17.0 17.0</p>	<p>123.8 53.8 Int. X 2 17.0 17.0 Ext. X 2</p>	<p>188.3 54.5 Int./Ext. X 4 16.6 17.0</p>



D80376740	D80476750	D80876810
D80876850	D81585300	D81676900
D82476250	D82576970	D82676980
D82776990	D82877010	D82977020
D83077030	D83177040	D83377060



<p>D83477070</p>	<p>D84077150</p>	<p>D84177160</p>
<p>D84377190</p>	<p>D85277290</p>	<p>D8527729A</p>
<p>D85377300</p>	<p>D85575660</p>	<p>D85677320</p>
<p>D85777330</p>	<p>D85877340</p>	<p>D86277380</p>
<p>D86577400</p>	<p>D86677410</p>	<p>D86683380</p>

© Schaeffler Automotive Aftermarket México S. de R.L. de C.V. se reserva todos y cada uno de los derechos sobre las fotografías exclusivas de la marca aquí presentadas; se prohíbe la reproducción parcial y/o total, uso, modificación y distribución de cada una de estas fotografías

D86777420	D86877430	D86977440
D87777550	D8777755B	D87975840
D88077570	D88177580	D8817758A
D88277590	D88377600	D88877660
D89777740	D89877750	D90077770



D90477820	D90577840	D90678960
D90877870	D90977880	D91077890
D91177900	D91379740	D91477950
D91877990	D92378240	D92878290
D9287829A	D93478370	D93578380

© Schaeffler Automotive Aftermarket México S. de R.L. de C.V. se reserva todos y cada uno de los derechos sobre las fotografías exclusivas de la marca aquí presentadas; se prohíbe la reproducción parcial y/o total, uso, modificación y distribución de cada una de estas fotografías

<p>D93978410</p>	<p>D94078420</p>	<p>D94378440</p>
<p>D94578460</p>	<p>D94675920</p>	<p>D94978480</p>
<p>D9497848A</p>	<p>D95078490</p>	<p>D9507849A</p>
<p>D95178500</p>	<p>D9517850A</p>	<p>D95278510</p>
<p>D95378520</p>	<p>D95678550</p>	<p>D95978570</p>



<p>D96478630</p>	<p>D96578640</p>	<p>D96678680</p>
<p>D96778690</p>	<p>D96978700</p>	<p>D97278730</p>
<p>D97478750</p>	<p>D97478810</p>	<p>D97678770</p>
<p>D98178630</p>	<p>D99578950</p>	<p>D99778980</p>
<p>D99878990</p>	<p>D10037904</p>	<p>D10117915</p>

<p>D10127916</p>	<p>D10157918</p>	<p>D10187921</p>
<p>D10217926</p>	<p>D10227927</p>	<p>D10287932</p>
<p>D10337937</p>	<p>D10357779</p>	<p>D10367939</p>
<p>D10377940</p>	<p>D10397943</p>	<p>D10417945</p>
<p>D10427427</p>	<p>D10447947</p>	<p>D10457948</p>









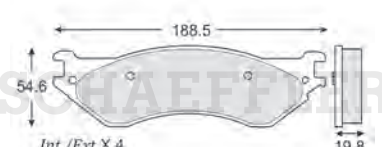
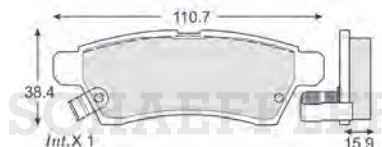
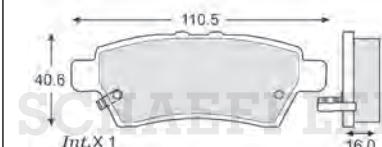

<p>D10467949</p>	<p>D10477950</p>	<p>D10517955</p>
<p>D10537958</p>	<p>D10557961</p>	<p>D10567962</p>
<p>D10577963</p>	<p>D10587965</p>	<p>D10588236</p>
<p>D10667972</p>	<p>D10677973</p>	<p>D10687973</p>
<p>D10697974</p>	<p>D10707975</p>	<p>D10717976</p>

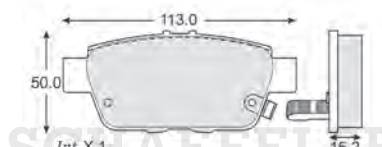
© Schaeffler Automotive Aftermarket México S. de R.L. de C.V. se reserva todos y cada uno de los derechos sobre las fotografías exclusivas de la marca aquí presentadas; se prohíbe la reproducción parcial y/o total, uso, modificación y distribución de cada una de estas fotografías

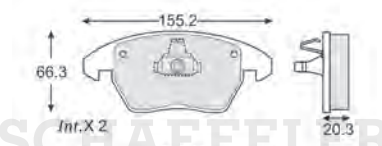
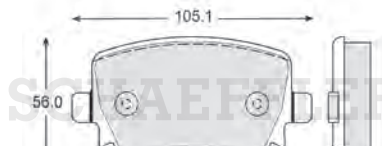
<p>D10757980</p>	<p>D10777982</p>	<p>D10807985</p>
<p>D10817986</p>	<p>D10827987</p>	<p>D10837915</p>
<p>D10847991</p>	<p>D10867418</p>	<p>D10877945</p>
<p>D10887993</p>	<p>D10897994</p>	<p>D10927997</p>
<p>D10937999</p>	<p>D10948200</p>	<p>D10957957</p>

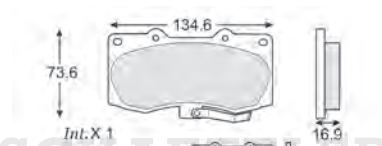
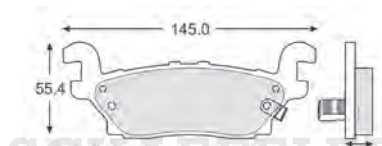

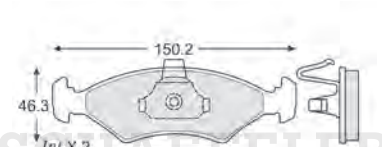
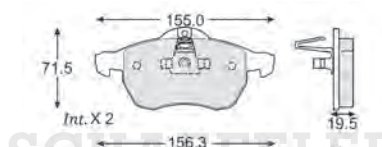
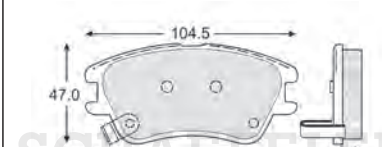
<p>D10967752</p>  <p>188.5 54.6 19.8 Int./Ext. X 4</p>	<p>D11008206</p>  <p>110.7 38.4 15.9 Int. X 1</p> <p>Int./Ext. X 3</p>	<p>D11018204</p>  <p>110.5 40.6 16.0 Int. X 1</p> <p>Ext. X 3</p>
<p>D11028208</p>  <p>157.7 58.7 18.0 Int. X 1</p> <p>Int. X 1 Ext. X 2</p>	<p>D11038209</p>  <p>113.0 50.0 15.2 Int. X 1</p> <p>Int. X 1 Ext. X 2</p>	<p>D11078212</p>  <p>155.2 66.3 20.3 156.4 71.6 Int. X 1 Ext. X 2</p>
<p>D11078212N</p>  <p>155.2 66.3 20.3 156.4 71.6 Int. X 2 Ext. X 2</p>	<p>D11088213</p>  <p>105.1 56.0 17.0 Int./Ext. X 4</p>	<p>D11098214</p>  <p>140.5 51.5 14.0 17.0 Int. X 1 Ext. X 1</p>
<p>D11198225</p>  <p>134.6 73.6 16.9 75.7 Int. X 1 Ext. X 2</p>	<p>D11208226</p>  <p>145.0 55.4 15.3 19.5 Int. X 1 Ext. X 2</p>	<p>D11378247</p>  <p>129.6 72.5 18.0 16.2 Int. X 1 Ext. X 2</p>
<p>D11408251</p>  <p>150.2 46.3 18.0 151.4 Int. X 2 Ext. X 2</p>	<p>D11418252</p>  <p>155.0 71.5 19.5 156.3 Int. X 2 Ext. X 1</p>	<p>D11428253</p>  <p>104.5 47.0 16.2 16.2 Int. X 1 Ext. X 2</p>

© Schaeffler Automotive Aftermarket México S. de R.L. de C.V. se reserva todos y cada uno de los derechos sobre las fotografías exclusivas de la marca aquí presentadas; se prohíbe la reproducción parcial y/o total, uso, modificación y distribución de cada una de estas fotografías

D11438254	D11458255	D11468256
D11478257	D11488258	D11498259
D11568266	D11578267	D11588268
D11608270	D11618272	D11648277
D11698282	D11698410	D11717286



D11738284	D11748287	D11758289
<p>104.2 53.5 Int. X 2 15.9 Ext. X 2</p>	<p>155.2 73.0 Int. X 1 19.8 156.5 74.8 Ext. X 2 18.5</p>	<p>150.2 61.1 Int. X 2 18.6 151.5 58.3 Ext. X 2</p>
D11768290	D11848301	D11848538
<p>131.6 55.5 Int. X 2 17.0 52.5 Ext. X 2</p>	<p>122.7 49.7 Int./Ext. X 4 17.5</p>	<p>122.7 49.7 Int./Ext. X 4 15.6</p>
D11878305	D11888307	D11898308
<p>82.5 57.0 Int./Ext. X 4 15.6</p>	<p>137.9 54.9 Int./Ext. X 4 16.4</p>	<p>156.4 52.8 Int. X 2 17.3 62.0 Ext. X 2</p>
D11908309	D11918310	D11928277
<p>130.0 56.0 Int./Ext. X 4 19.0</p>	<p>168.5 58.5 Int. X 1 16.9 Int. X 1 Ext. X 2 16.9</p>	<p>136.7 58.9 Int. X 1 17.5 Int. X 1 Ext. X 2 17.5</p>
D11938311	D11948312	D11958315
<p>135.1 48.5 Int./Ext. X 3 15.4 Int. X 1</p>	<p>142.7 45.7 Int. X 1 16.9 Int. X 1 Ext. X 2 16.9</p>	<p>136.7 53.6 Int. X 1 16.4 Int. X 1 Ext. X 2 16.4</p>

© Schaeffler Automotive Aftermarket México S. de R.L. de C.V. se reserva todos y cada uno de los derechos sobre las fotografías exclusivas de la marca aquí presentadas; se prohíbe la reproducción parcial y/o total, uso, modificación y distribución de cada una de estas fotografías

<p>D11968316</p>	<p>D12008320</p>	<p>D12048324</p>
<p>D12108330</p>	<p>D12118331</p>	<p>D12128332</p>
<p>D12148334</p>	<p>D12158335</p>	<p>D12168336</p>
<p>D12228331</p>	<p>D12508368</p>	<p>D12528370</p>
<p>D12588377</p>	<p>D12598378</p>	<p>D12648381</p>



<p>D12658382</p>	<p>D12688383</p>	<p>D12688383S</p>
<p>D12688383A</p>	<p>D12698385</p>	<p>D12738389</p>
<p>D12748390</p>	<p>D12758391</p>	<p>D12788394</p>
<p>D12798395</p>	<p>D12808396</p>	<p>D12818397</p>
<p>D12868403</p>	<p>D12938331</p>	<p>D13038419</p>



© Schaeffler Automotive Aftermarket México S. de R.L. de C.V. se reserva todos y cada uno de los derechos sobre las fotografías exclusivas de la marca aquí presentadas; se prohíbe la reproducción parcial y/o total, uso, modificación y distribución de cada una de estas fotografías

D13048420	D13088423	D13098424
D13157939	D13168430	D13168430S
D13168430A	D13178431	D13178431S
D13178431A	D13188432	D13188432S
D13188432A	D13218433	D13228434



D13248436	D13258437	D13268438
D13278439	D13278481	D13288440
D13298441	D13338782	D13348652
D13368447	D13388449	D13398450
D13458456	D13548463	D13618470

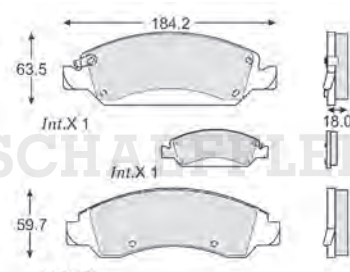
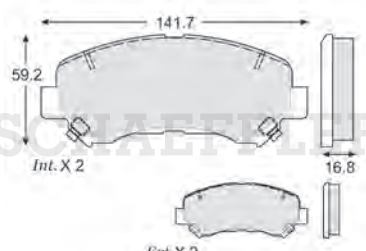
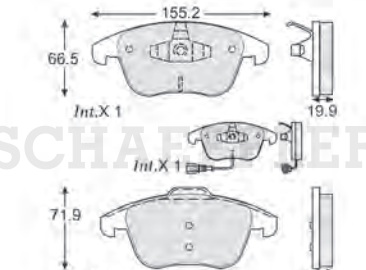
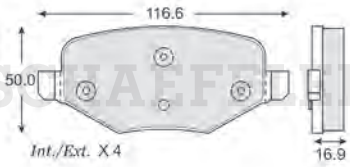
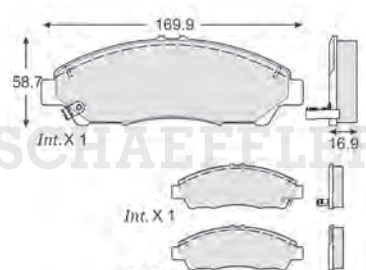
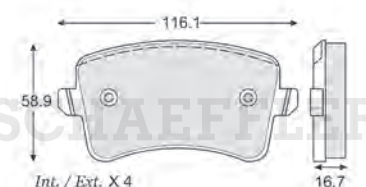
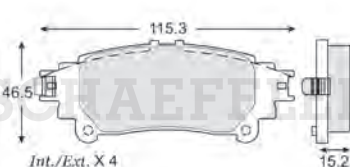

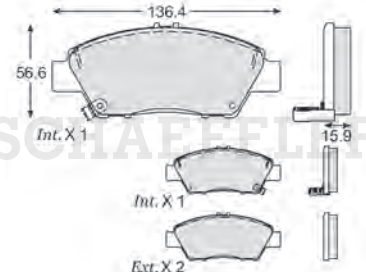
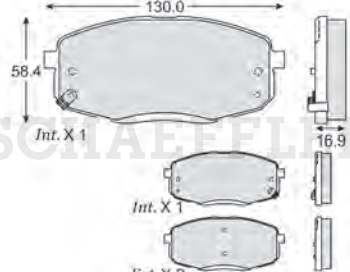
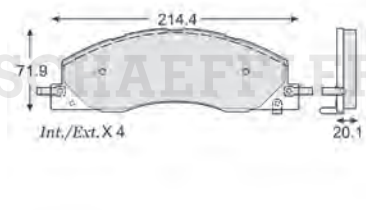
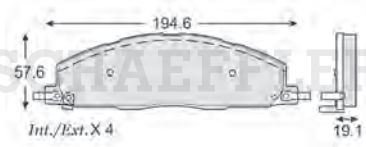
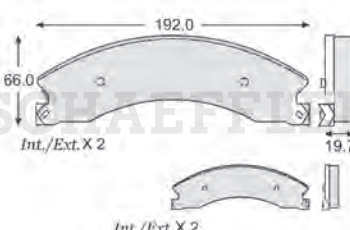
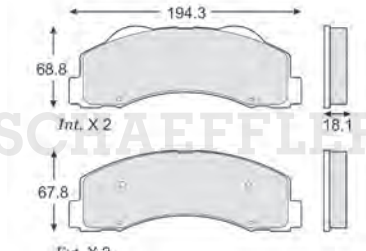
<p>D13628471</p> 	<p>D13638472</p> 	<p>D13748449</p> 
<p>D13758486</p> 	<p>D13778488</p> 	<p>D13788396</p> 
<p>D13868494</p> 	<p>D13918500</p> 	<p>D13927915</p> 
<p>D13948502</p> 	<p>D13978505</p> 	<p>D13998507</p> 
<p>D14008508</p> 	<p>D14118523</p> 	<p>D14148528</p> 



<p>D14158405</p>	<p>D14218536</p>	<p>D14238463</p>
<p>D14308547</p>	<p>D14348552</p>	<p>D14378555</p>
<p>D14478615</p>	<p>D14518447</p>	<p>D14548653</p>
<p>D14548738</p>	<p>D14558655</p>	<p>D14568656</p>
<p>D14608660</p>	<p>D14618661</p>	<p>D14678667</p>

© Schaeffler Automotive Aftermarket México S. de R.L. de C.V. se reserva todos y cada uno de los derechos sobre las fotografías exclusivas de la marca aquí presentadas; se prohíbe la reproducción parcial y/o total, uso, modificación y distribución de cada una de estas fotografías

D14688668	D14718671	D14808679
<p>116.6 42.7 Int. X 1 16.2 Ext. X 2</p>	<p>126.8 49.5 Int./Ext. X 4 13.9</p>	<p>63.8 57.5 Int./Ext. X 4 16.5</p>
D14828658	D14878687	D14958695
<p>105.0 54.3 Int./Ext. X 4 11.0</p>	<p>164.7 66.5 Int. X 2 20.2 Ext. X 2</p>	<p>136.8 59.5 Int./Ext. X 4 18.1</p>
D14978697	D14988698	D14998254
<p>148.1 60.9 Int. X 1 17.9 Ext. X 2</p>	<p>140.2 50.8 Int. X 2 141.5 59.5 Ext. X 2</p>	<p>130.8 47.4 Int. X 2 18.0 Ext. X 2</p>
D15008699	D15018700	D15028701
<p>144.9 61.6 Int./Ext. X 4 18.5</p>	<p>155.4 71.0 Int. X 2 156.4 68.5 Ext. X 2</p>	<p>122.8 54.0 Int./Ext. X 4 17.3 X 2</p>
D15028701N	D15067656	D15077760
<p>122.8 54.0 Int./Ext. X 4 17.3</p>	<p>148.8 47.0 Int./Ext. X 4 17.3</p>	<p>137.7 47.0 Int. X 1 17.4 Ext. X 2</p>



D15088715	D15098403	D15198728
<p>195.3 54.6 Int./Ext. X 4 17.9</p>	<p>169.9 63.0 Int. X 1 17.9 Int. X 1 Ext. X 2</p>	<p>155.5 51.3 Int./Ext. X 4 15.7</p>
D15208729	D15217994	D15228730
<p>153.8 58.7 Int./Ext. X 4 17.5</p>	<p>154.9 58.1 Int./Ext. X 2 17.9 Int./Ext. X 2</p>	<p>148.1 60.9 Int. X 1 18.1 Int. X 1 Ext. X 2</p>
D15238731	D15288736	D15288736N
<p>140.2 55.6 Int. / Ext. X 4 15.6</p>	<p>164.8 65.4 Int./Ext. X 4 18.9 X 2</p>	<p>164.8 65.4 Int./Ext. X 4 18.9</p>
D15328741	D15388747	D15408748
<p>160.0 63.0 Int. X 1 17.0 177.7 62.0 Ext. X 1 17.0 Ext. X 1</p>	<p>151.4 52.5 Int. X 2 18.0 Ext. X 2</p>	<p>169.2 69.6 Int. / Ext. X 3 18.3 Int. X 1</p>
D15418872	D15448428	D15508759
<p>137.0 57.4 Int./Ext. X 4 19.0</p>	<p>99.8 41.7 Int. X 1 14.8 Int. X 1 Ext. X 2</p>	<p>166.4 63.3 Int. / Ext. X 4 21.0</p>

© Schaeffler Automotive Aftermarket México S. de R.L. de C.V. se reserva todos y cada uno de los derechos sobre las fotografías exclusivas de la marca aquí presentadas; se prohíbe la reproducción parcial y/o total, uso, modificación y distribución de cada una de estas fotografías

D15538763	D15548764	D15558767
D15568768	D15658774	D15668775
D15678776	D15688777	D15698778
D15708779	D15718780	D15728781
D15788791	D15818793	D15828794



<p>D15848208</p>	<p>D15858397</p>	<p>D15898800</p>
<p>D15908801</p>	<p>D15928804</p>	<p>D15938806</p>
<p>D15948428</p>	<p>D15958810</p>	<p>D15968811</p>
<p>D16018815</p>	<p>D16028816</p>	<p>D16118824</p>
<p>D16128825</p>	<p>D16148827</p>	<p>D16228834</p>

© Schaeffler Automotive Aftermarket México S. de R.L. de C.V. se reserva todos y cada uno de los derechos sobre las fotografías exclusivas de la marca aquí presentadas; se prohíbe la reproducción parcial y/o total, uso, modificación y distribución de cada una de estas fotografías

<p>D16238836</p>	<p>D16248837</p>	<p>D16278844</p>
<p>D16298856</p>	<p>D16338849</p>	<p>D16388865</p>
<p>D16408867</p>	<p>D16418868</p>	<p>D16458873</p>
<p>D16478875</p>	<p>D16498877</p>	<p>D16508878</p>
<p>D16538882</p>	<p>D16548883</p>	<p>D16638891</p>



<p>D16768905</p> <p>194.1 68.6 15.5 Int. X 1 Int. X 1 Ext. X 2</p>	<p>D16778906</p> <p>151.9 60.7 15.8 Int. X 1 Int. X 1 Ext. X 2</p>	<p>D16788907</p> <p>149.1 62.0 16.4 Int. X 1 Int. X 1 Ext. X 2</p>
<p>D16798908</p> <p>101.3 44.5 14.3 Int. X 1 Int. X 1 Ext. X 2</p>	<p>D16808909</p> <p>213.1 71.6 18.2 Int./Ext. X 4</p>	<p>D16918918</p> <p>193.3 62.0 18.1 Int./Ext. X 4</p>
<p>D169384305</p> <p>163.3 67.3 20.1 Int./Ext. X 4 X 2</p>	<p>D16978840</p> <p>148.8 62.2 16.9 Int. X 1 Int. X 1 Ext. X 2</p>	<p>D169983835</p> <p>169.2 73.0 20.1 Int./Ext. X 4 X 2</p>
<p>D17008924</p> <p>178.3 68.1 21.0 Int./Ext. X 4 X 2</p>	<p>D17028926</p> <p>142.0 52.0 17.0 Int. X 2 Ext. X 2</p>	<p>D17118936</p> <p>140.2 59.7 15.5 Int./Ext. X 4</p>
<p>D17178942</p> <p>155.4 58.7 17.4 Int. X 2 155.2 65.0 18.0 Ext. X 2</p>	<p>D17218945</p> <p>155.2 69.3 19.3 Int. X 1 71.9 18.0 Ext. X 2</p>	<p>D17238396</p> <p>169.9 58.7 16.9 Int. X 1 Int. X 1 Ext. X 2</p>

© Schaeffler Automotive Aftermarket México S. de R.L. de C.V. se reserva todos y cada uno de los derechos sobre las fotografías exclusivas de la marca aquí presentadas; se prohíbe la reproducción parcial y/o total, uso, modificación y distribución de cada una de estas fotografías

<p>D17248397</p>	<p>D17288952</p>	<p>D17298953</p>
<p>D17308954</p>	<p>D17318956</p>	<p>D17348958</p>
<p>D17358960</p>	<p>D17368906</p>	<p>D17378449</p>
<p>D17458971</p>	<p>D17548970</p>	<p>D17598987</p>
<p>D17608989</p>	<p>D17618990</p>	<p>D17668997</p>



D17678998	D17708528	D17718896
<p>181.4 72.1 20.4 Int./Ext. X 4</p>	<p>194.3 69.1 18.1 Int. X 2 68.3 Ext. X 2</p>	<p>180.1 65.5 17.3 Int. X 2 Ext. X 2</p>
D17749004	D17759005	D17769006
<p>172.0 66.3 16.4 Int. / Ext. X 2</p>	<p>136.9 58.9 17.5 Int. X 2 56.4 Ext. X 2</p>	<p>131.3 52.6 17.0 Int. X 2 Ext. X 2</p>
D17799008	D17869013	D17879014
<p>104.1 53.1 16.5 Int. / Ext. X 4</p>	<p>136.9 61.7 17.3 Int. X 2 59.2 Ext. X 2</p>	<p>172.0 69.3 16.4 Int. / Ext. X 4</p>
D18029034	D18069041	D18099044
<p>146.1 79.8 16.0 Int. X 2 89.4 Ext. X 1</p>	<p>113.3 49.3 15.5 Int. X 1 Int. X 1 Ext. X 2</p>	<p>115.6 49.5 16.5 Int. X 1 Int. X 1 Ext. X 2</p>
D18119046	D18128428	D18159049
<p>141.0 64.3 19.4 Int. X 1 Int. X 1 Ext. X 2</p>	<p>99.8 41.7 14.8 Int. X 1 Int. X 1 Ext. X 2</p>	<p>132.8 59.9 16.4 Int. X 1 Int. X 1 Ext. X 2</p>

© Schaeffler Automotive Aftermarket México S. de R.L. de C.V. se reserva todos y cada uno de los derechos sobre las fotografías exclusivas de la marca aquí presentadas; se prohíbe la reproducción parcial y/o total, uso, modificación y distribución de cada una de estas fotografías

<p>D18169051</p> <p>116.8 48.3 Int. X 1 14.8 Int. X 1 Ext. X 2</p>	<p>D18189053</p> <p>193.3 65.0 Int. X 2 18.5 Ext. X 2 17.8</p>	<p>D18209056</p> <p>106.2 45.7 Int. / Ext. X 4 15.2</p>
<p>D18309061</p> <p>140.2 42.2 Int. X 2 17.2 Ext. X 2</p>	<p>D18338893</p> <p>123.2 53.3 Int. X 2 15.0 48.5 Ext. X 2</p>	<p>D18409068</p> <p>141.5 58.9 Int. X 2 19.9 Ext. X 2</p>
<p>D18419069</p> <p>116.6 45.5 Int. X 2 16.0 Ext. X 2</p>	<p>D18429070</p> <p>169.2 69.6 Int. X 2 19.8 Ext. X 2</p>	<p>D18438932</p> <p>167.1 62.0 Int. / Ext. X 4 17.5</p>
<p>D18469073</p> <p>112.3 42.7 Int. / Ext. X 2 14.4 Int. / Ext. X 2</p>	<p>D18479075</p> <p>140.7 61.0 Int. X 1 16.8 Int. X 1 Ext. X 2 14.8</p>	<p>D18488428</p> <p>99.6 41.7 Int. X 1 14.8 Int. X 1 Ext. X 2</p>
<p>D18529081</p> <p>125.7 51.6 Int. X 2 15.4 Ext. X 2</p>	<p>D18558614</p> <p>138.2 62.0 Int. X 1 16.8 Int. X 1 Ext. X 2</p>	<p>D18569036</p> <p>93.0 41.4 Int. X 1 14.9 Int. X 1 Ext. X 2</p>



<p>D18649093</p>	<p>D18749103</p>	<p>D18789106</p>
<p>D18799107</p>	<p>D18969124</p>	<p>D18989126</p>
<p>D19019128</p>	<p>D19069135</p>	<p>D19109139</p>
<p>D19119141</p>	<p>D19129143</p>	<p>D19139144</p>
<p>D19269151</p>	<p>D19299072</p>	<p>D19349157</p>

© Schaeffler Automotive Aftermarket México S. de R.L. de C.V. se reserva todos y cada uno de los derechos sobre las fotografías exclusivas de la marca aquí presentadas; se prohíbe la reproducción parcial y/o total, uso, modificación y distribución de cada una de estas fotografías

<p>D19399164</p>	<p>D19409165</p>	<p>D19429167</p>
<p>D19509175</p>	<p>D19539180</p>	<p>D19689193</p>
<p>D19709195</p>	<p>D19749201</p>	<p>D20059304</p>
<p>D20079237</p>	<p>D20189249</p>	<p>D20199144</p>
<p>D20249254</p>	<p>D20368840</p>	<p>D20379268</p>

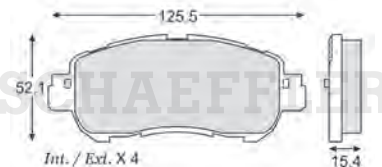
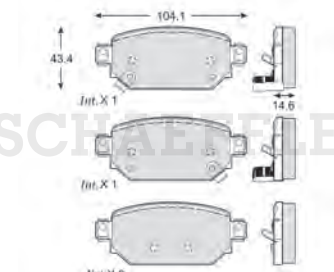
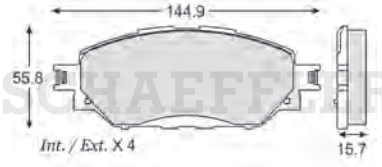
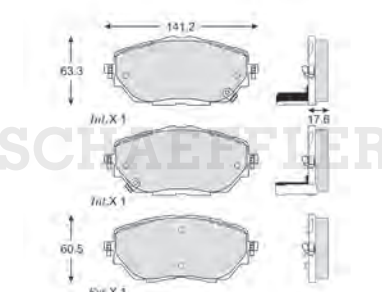
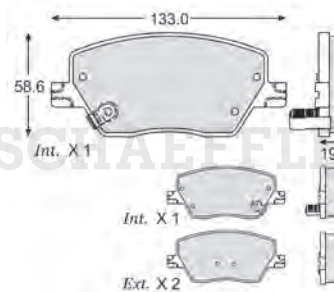
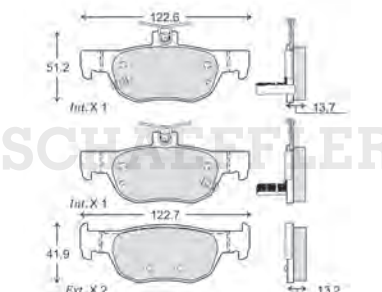
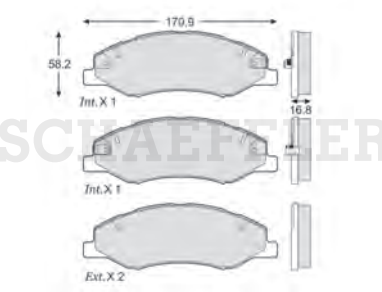
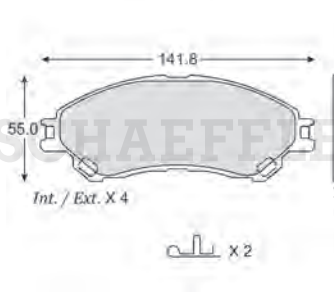
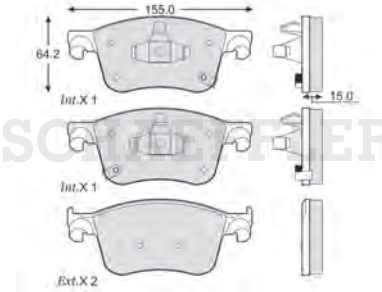
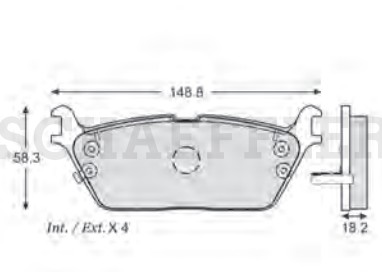
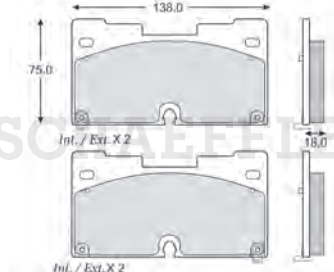
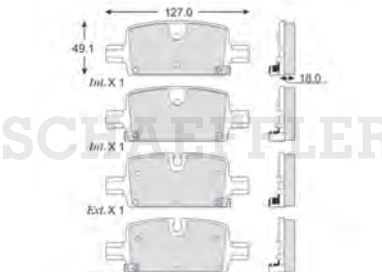
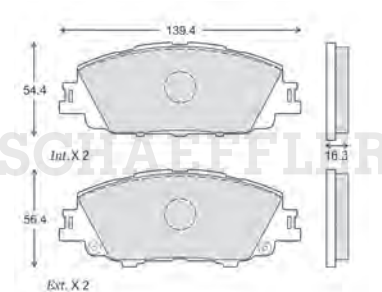
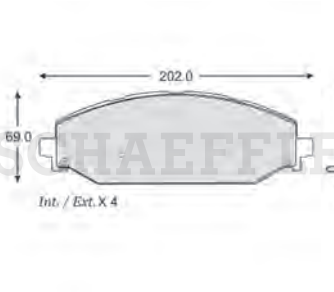
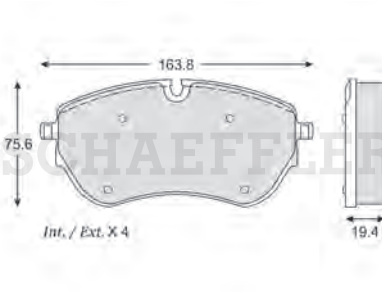

<p>D20389269</p>  <p>125.5 52.1 15.4 Int. / Ext. X 4</p>	<p>D20429271</p>  <p>104.1 43.4 14.6 Int. X 1 Ext. X 2</p>	<p>D20589236</p>  <p>144.9 55.8 15.7 Int. / Ext. X 4</p>
<p>D20659297</p>  <p>141.2 63.3 17.6 Int. X 1 Ext. X 1</p>	<p>D20669298</p>  <p>133.0 58.6 19.3 Int. X 1 Ext. X 2</p>	<p>D20769311</p>  <p>122.6 51.2 13.7 Int. X 1 Ext. X 2</p>
<p>D20899324</p>  <p>170.9 58.2 16.8 Int. X 1 Ext. X 2</p>	<p>D20969331</p>  <p>141.8 55.0 16.0 Int. / Ext. X 4 X 2</p>	<p>D21159349</p>  <p>155.0 64.2 15.0 Int. X 1 Ext. X 2</p>
<p>D21699414</p>  <p>148.8 58.3 18.2 Int. / Ext. X 4</p>	<p>D21739418</p>  <p>138.0 75.0 18.0 Int. / Ext. X 2</p>	<p>D21749419</p>  <p>127.0 49.1 18.0 Int. X 1 Ext. X 1</p>
<p>D21769421</p>  <p>139.4 54.4 16.3 56.4 Int. X 2 Ext. X 2</p>	<p>D21799424</p>  <p>202.0 69.0 19.7 Int. / Ext. X 4</p>	<p>D21969437</p>  <p>163.8 75.6 19.4 Int. / Ext. X 4</p>

D21979438	D22189458	D22199459
D22239462	D22259464	D22369475
D22479483	D22489484	D22499485
D22689508	D22729512	D23009536
D23069541	D23109545	D23859611



D00010030	D00012160	D00012200
D00013050	D0001305A	D00013100
D00013470	D00013490	D00013800
D00014050		





Embragues de Tractor LuK: ¡El número uno en el campo!

Los embragues LuK hacen más que garantizar la operabilidad del tractor. Muchas veces, también tienen que hacer funcionar máquinas secundarias a través de la toma de fuerza.

Todos los fabricantes líderes de tractores confían en la durabilidad, rentabilidad y las excelentes cualidades de amortiguación de los sistemas de embrague de tractor LuK. Nuestra amplia gama de productos proporciona el embrague adecuado para cada propósito.

No es casualidad que LuK sea el líder mundial en embragues agrícolas.

SCHAEFFLER

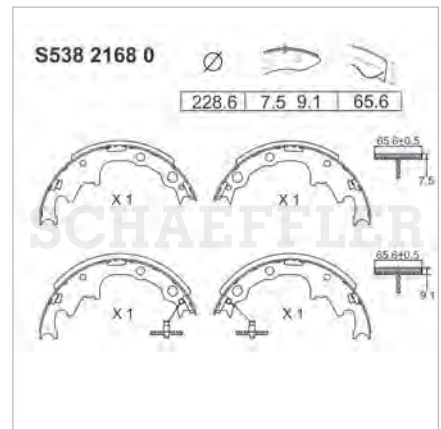
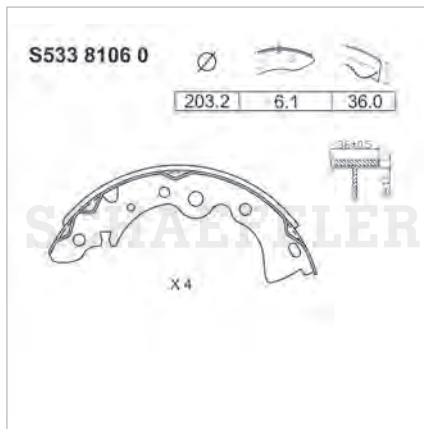
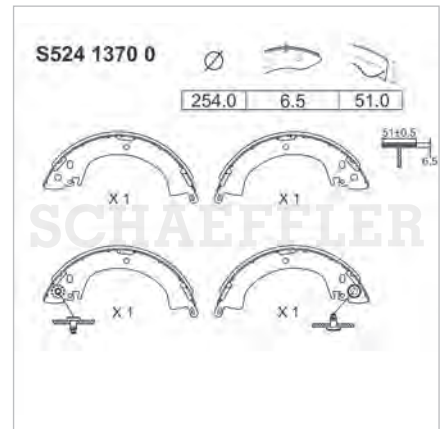
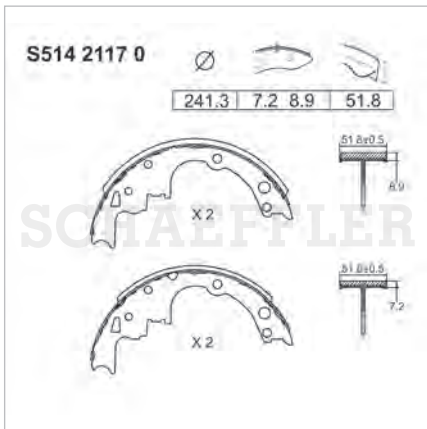
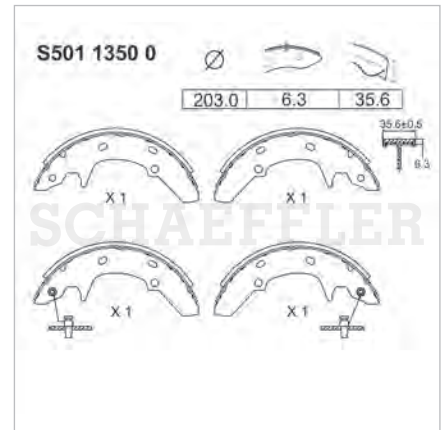
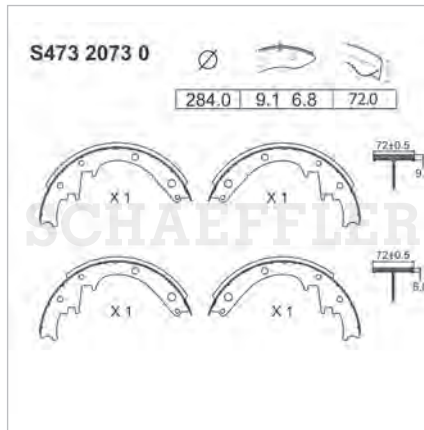
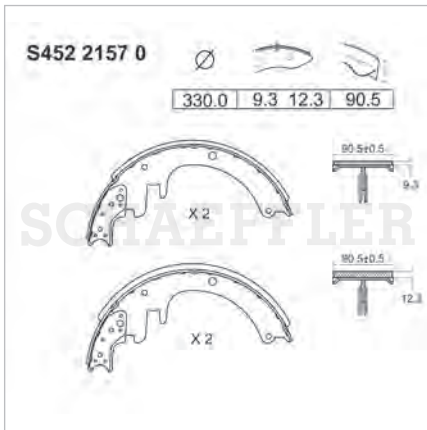
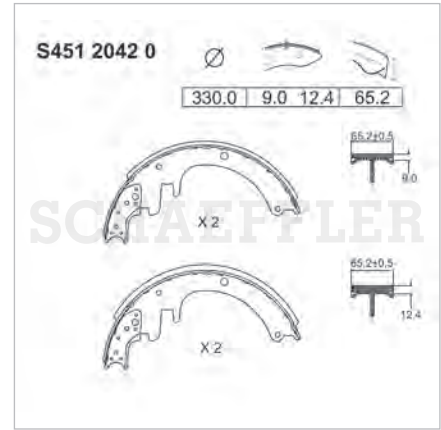
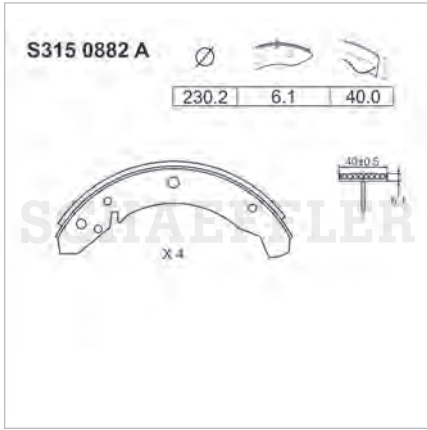

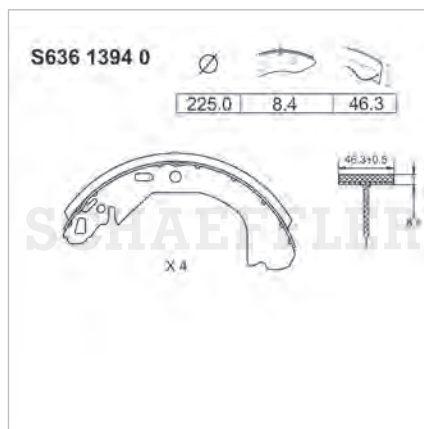
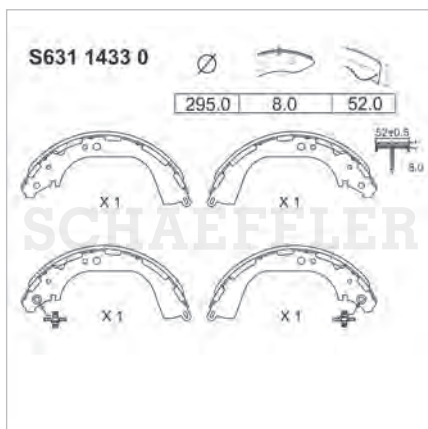
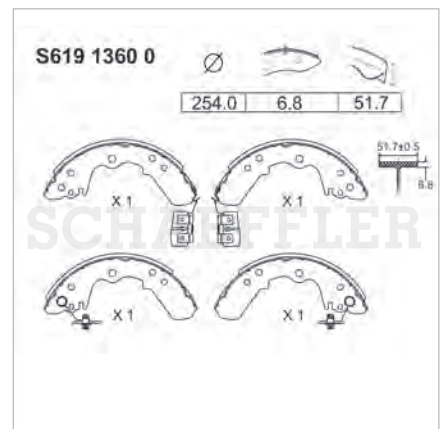
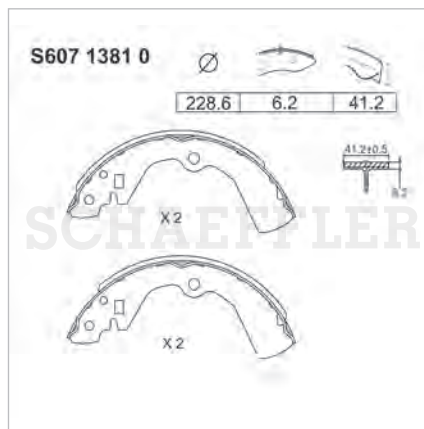
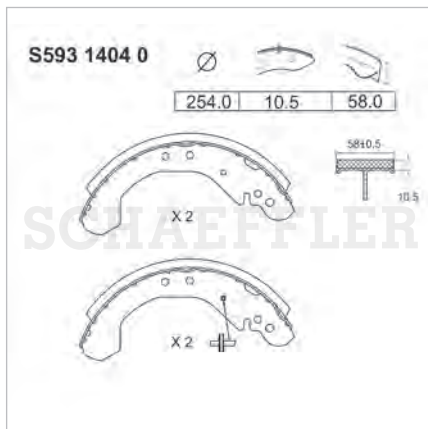
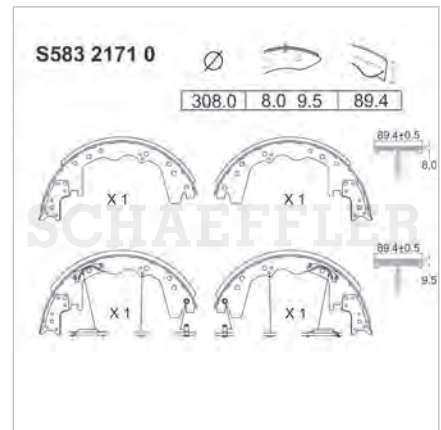
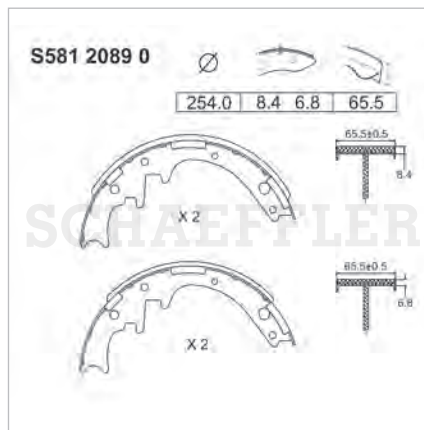
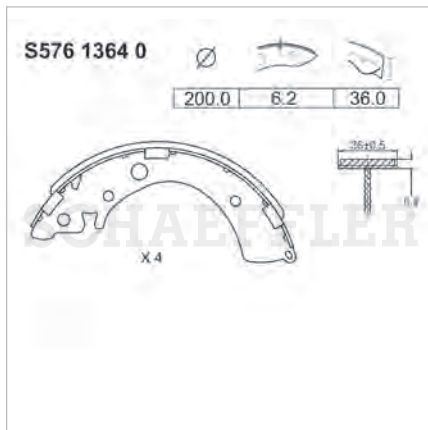
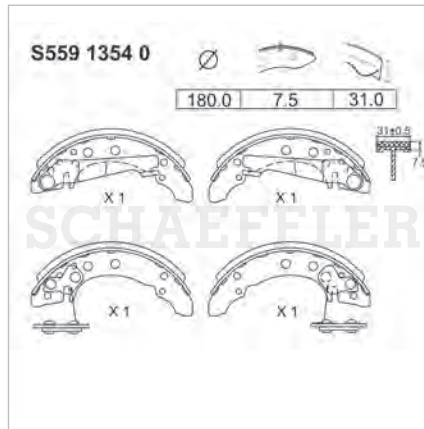
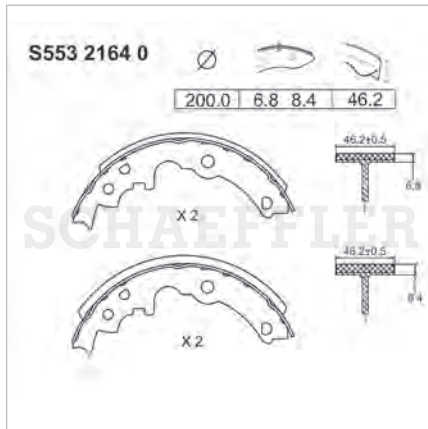

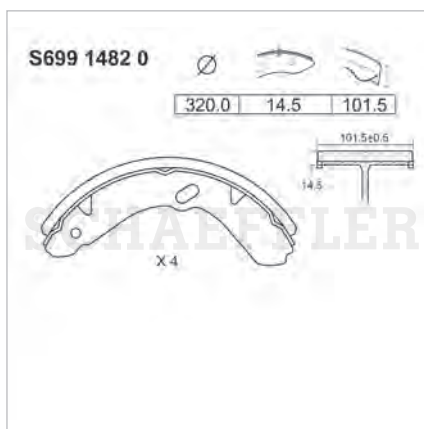
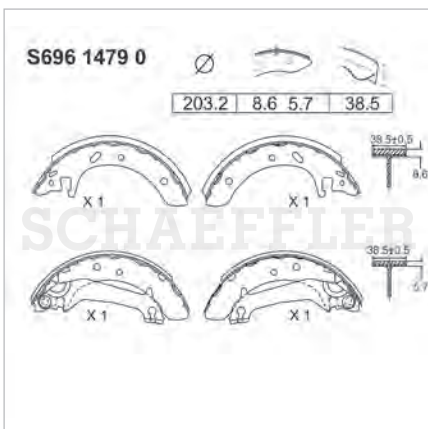
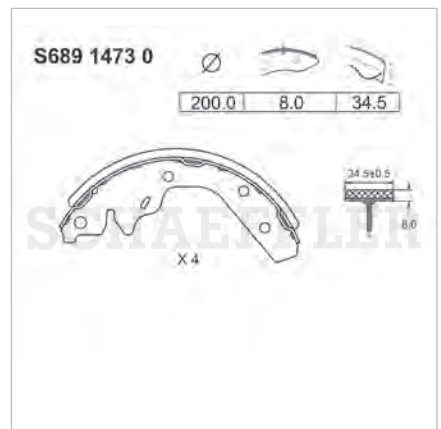
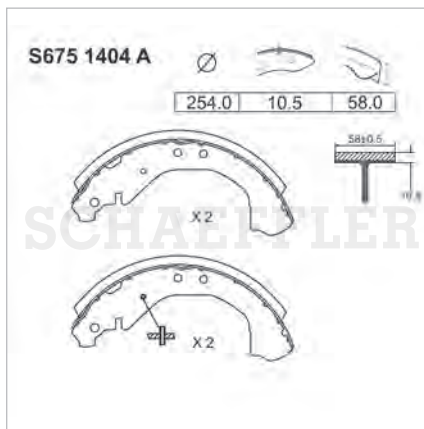
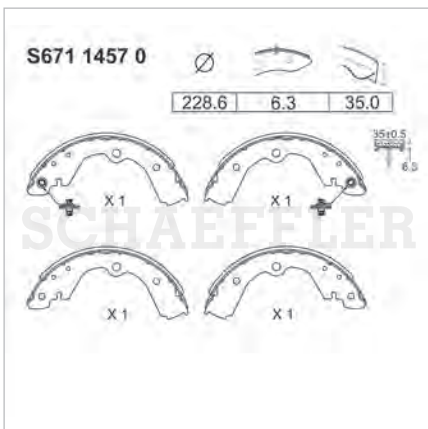
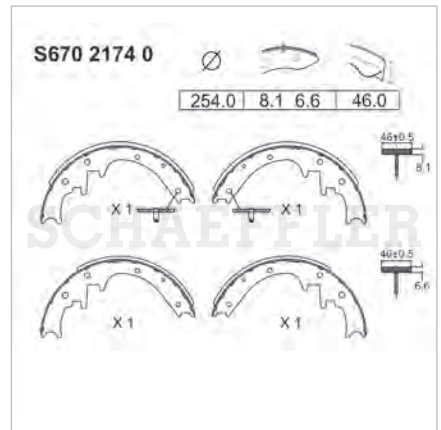
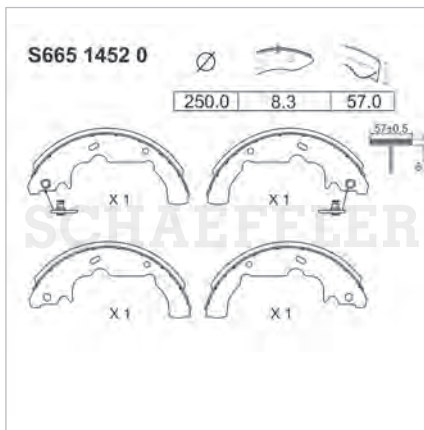
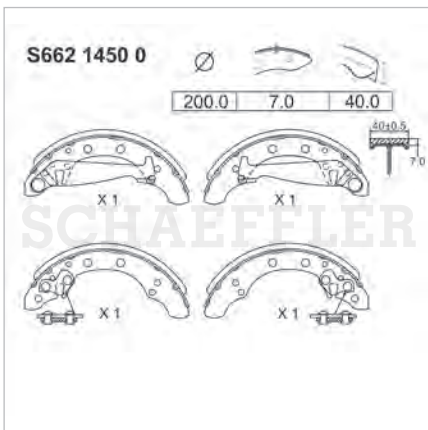
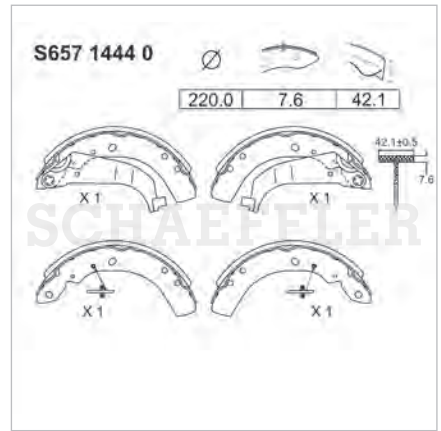
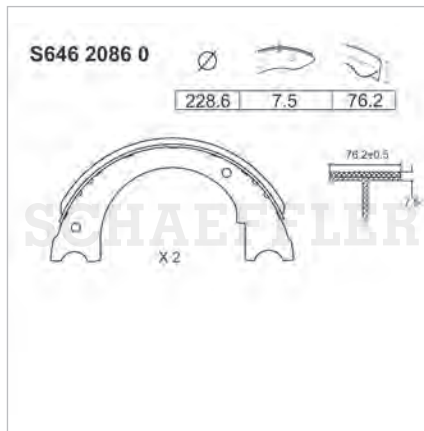

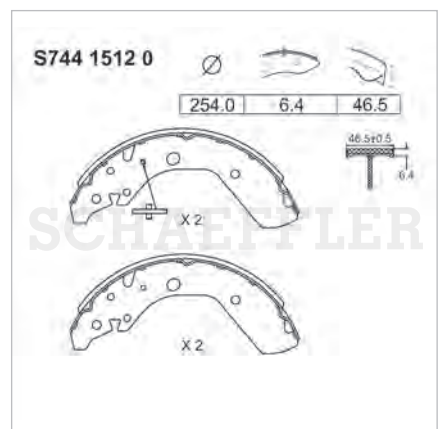
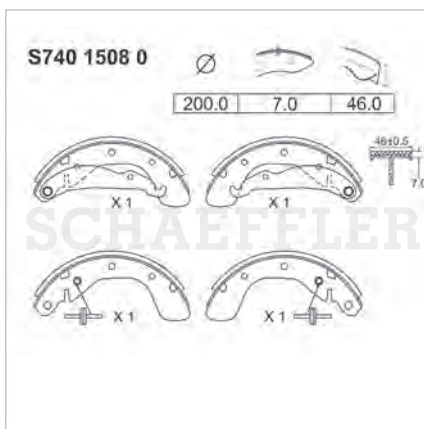
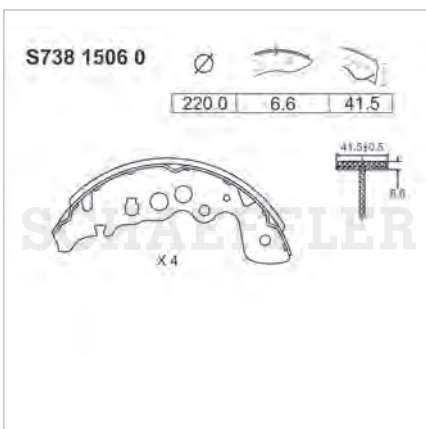
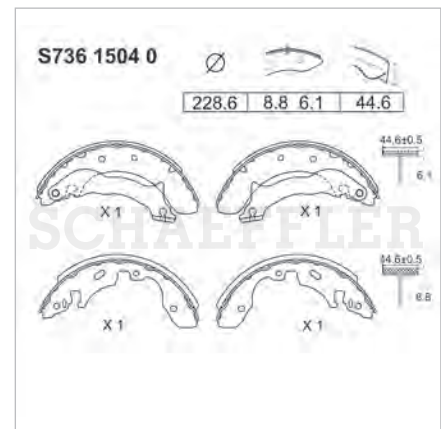
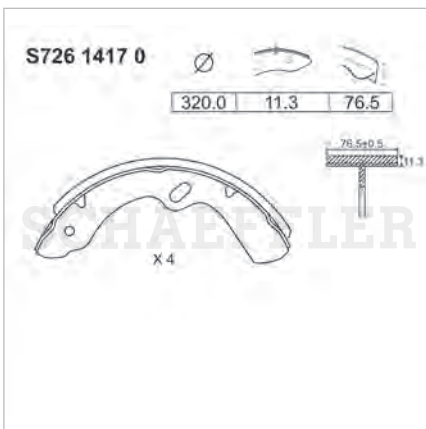
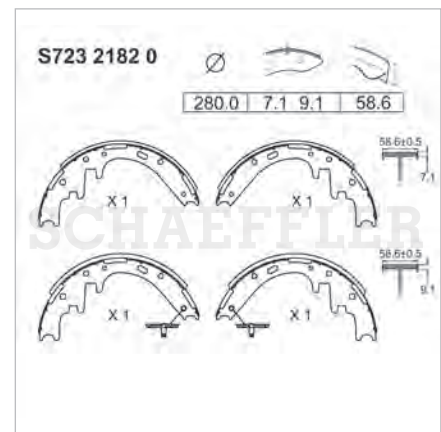
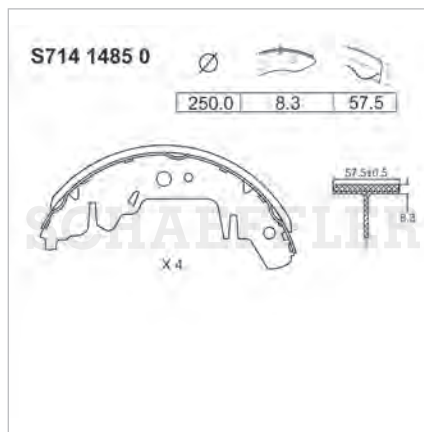
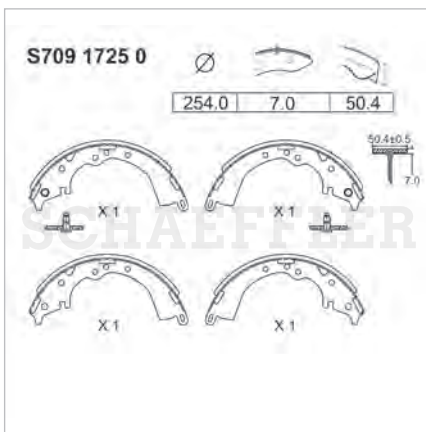
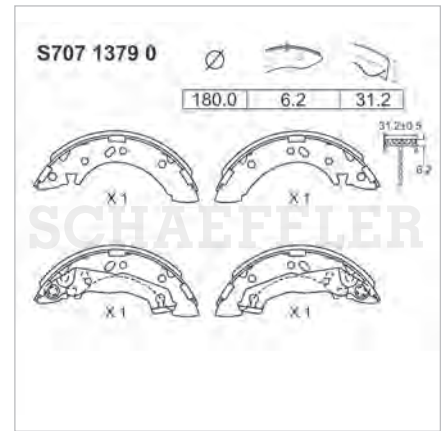

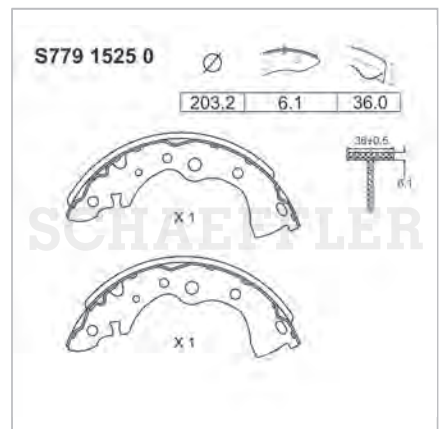
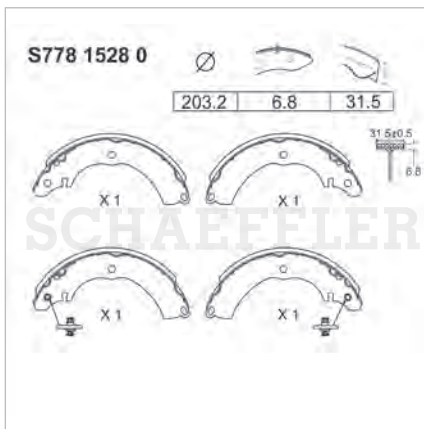
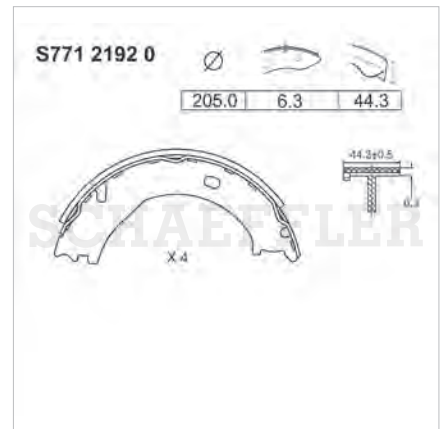
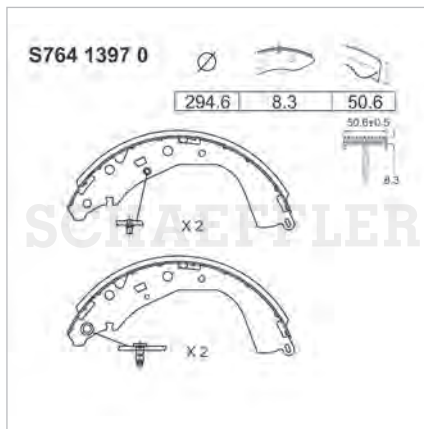
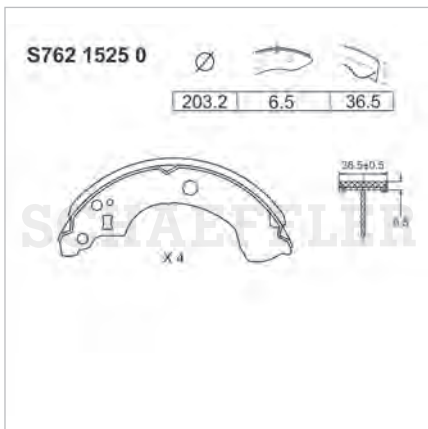
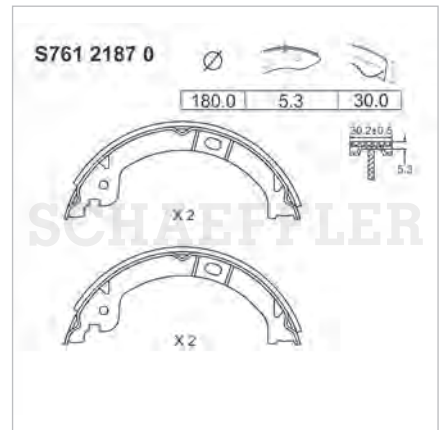
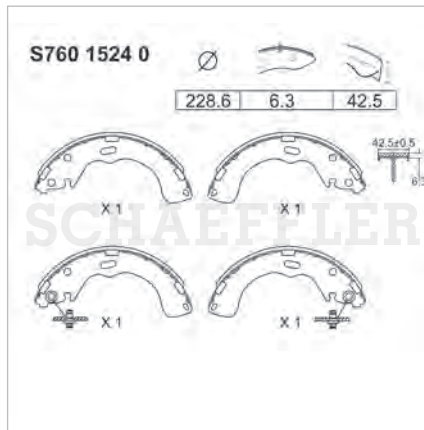
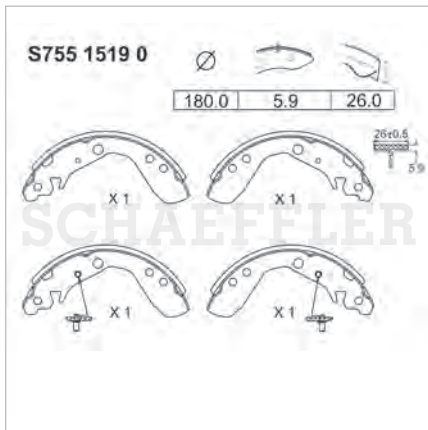
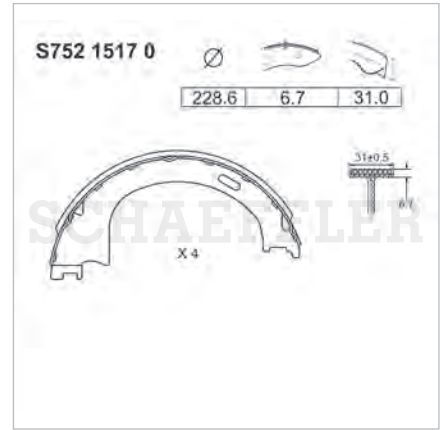
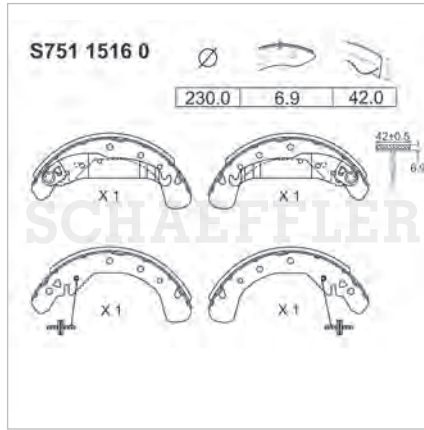

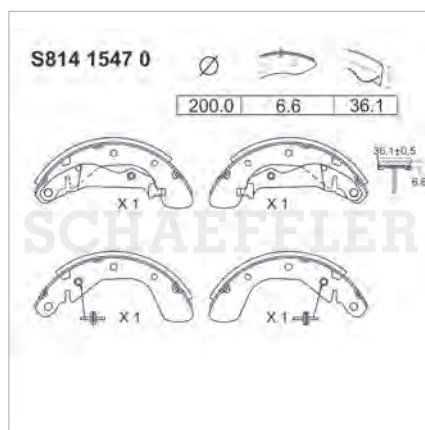
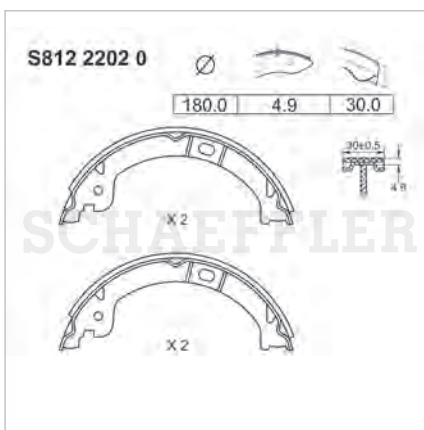
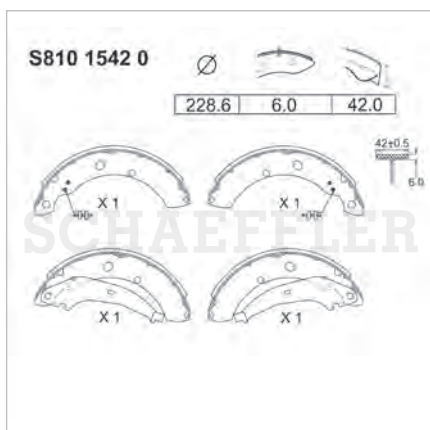
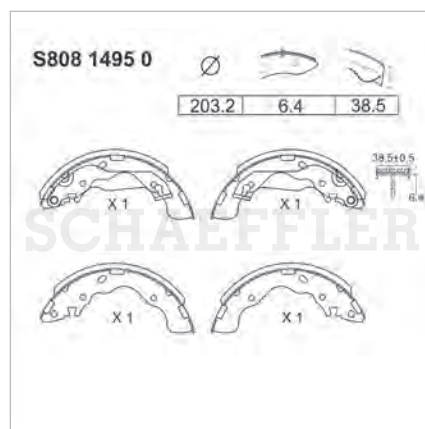
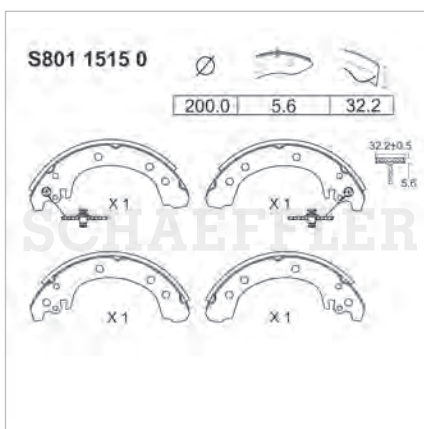
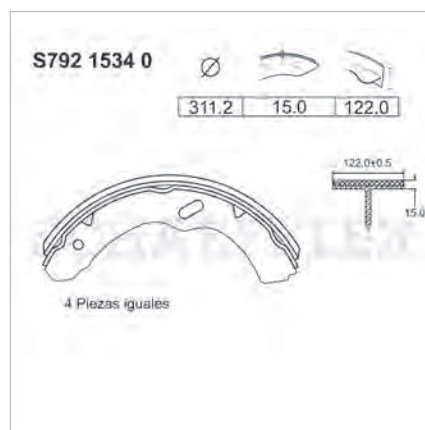
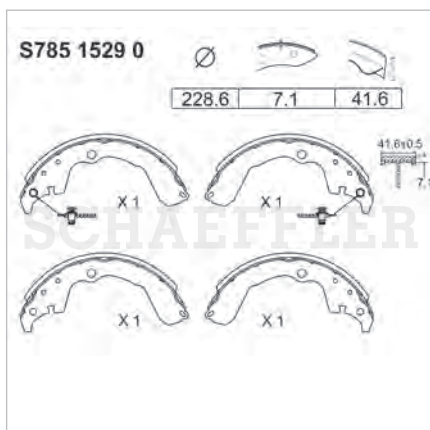
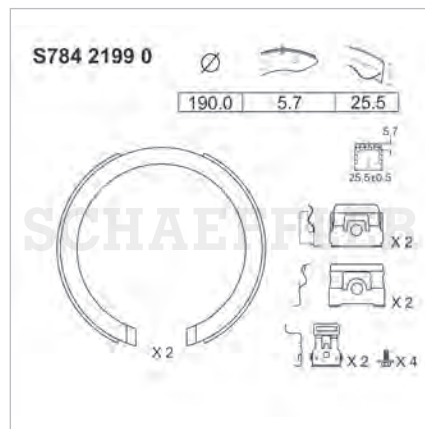
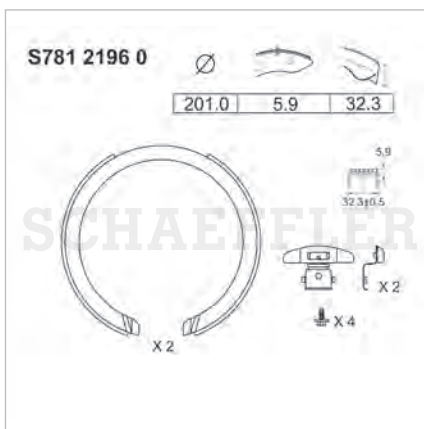
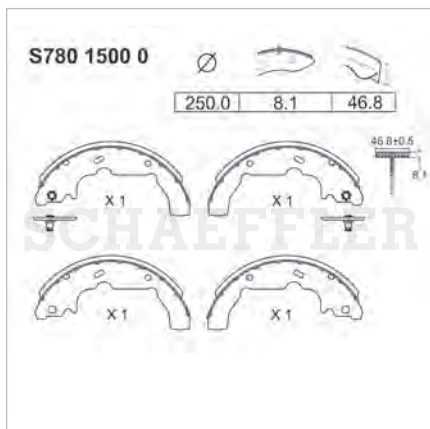

© Schaeffler Automotive Aftermarket Mexico S. de R.L. de C.V. se reserva todos y cada uno de los derechos sobre las fotografías exclusivas de la marca aquí presentadas; se prohíbe la reproducción parcial y/o total, uso, modificación y distribución de cada una de estas fotografías

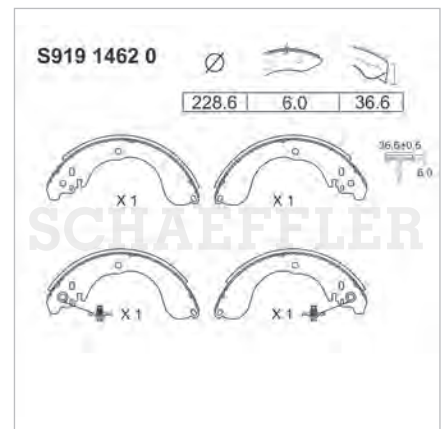
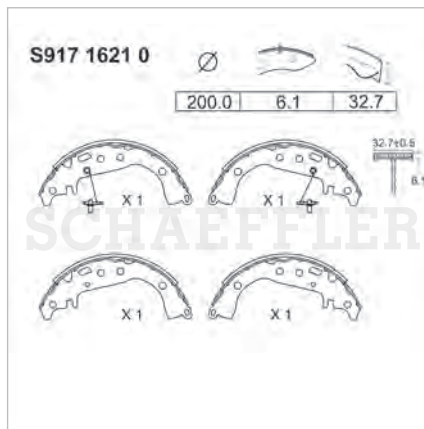
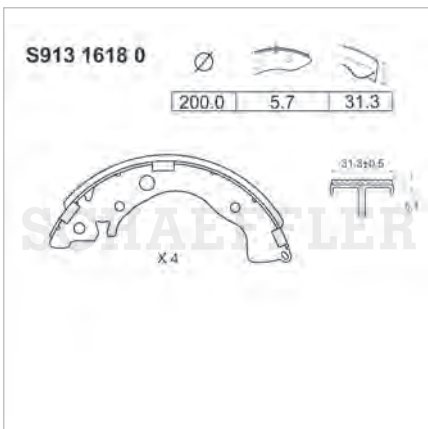
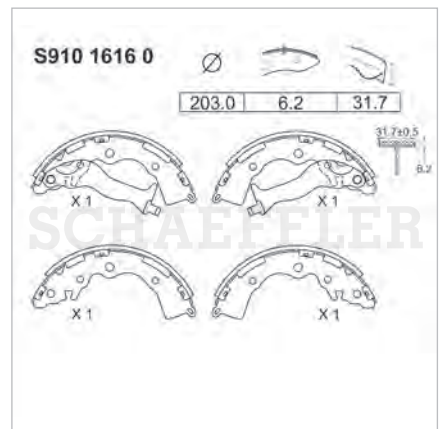
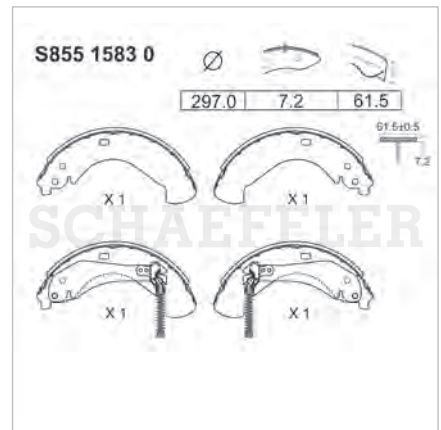
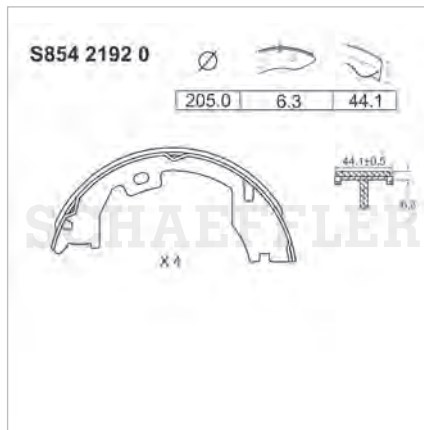
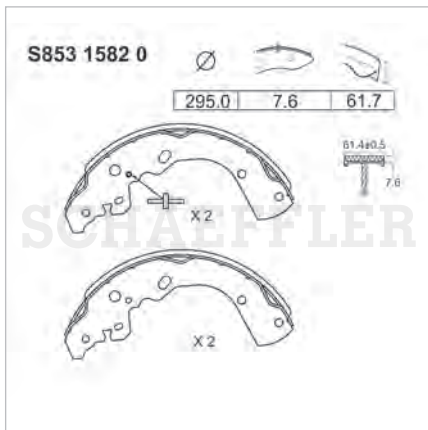
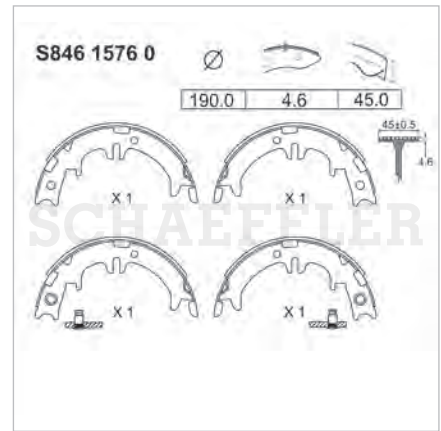
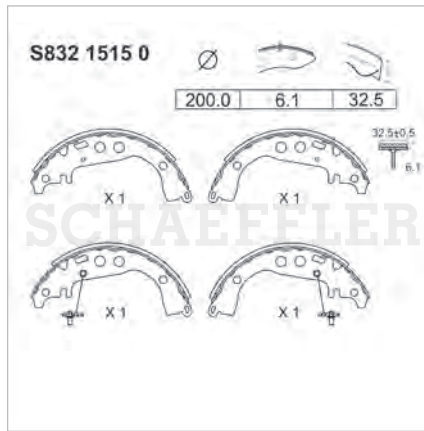
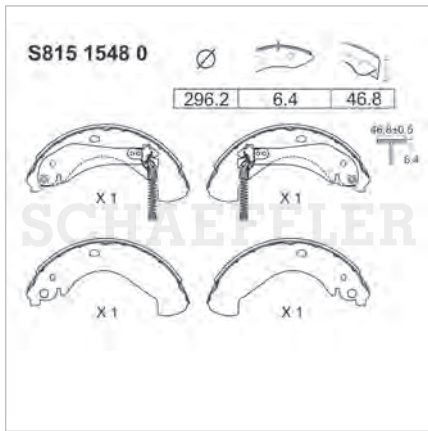

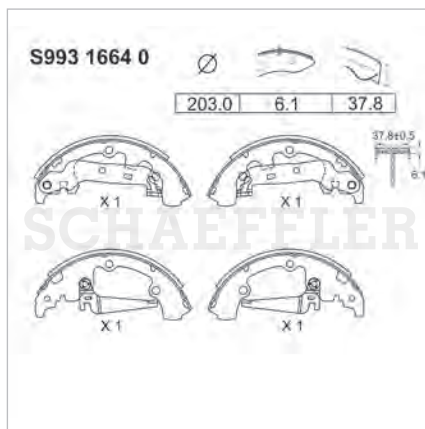
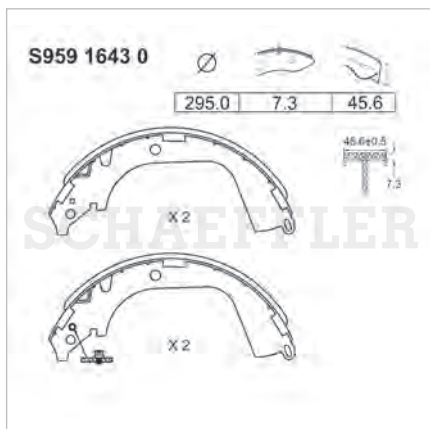
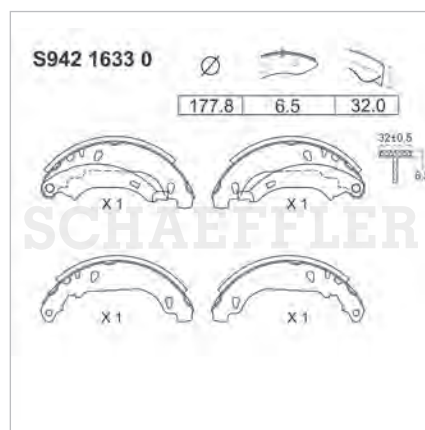
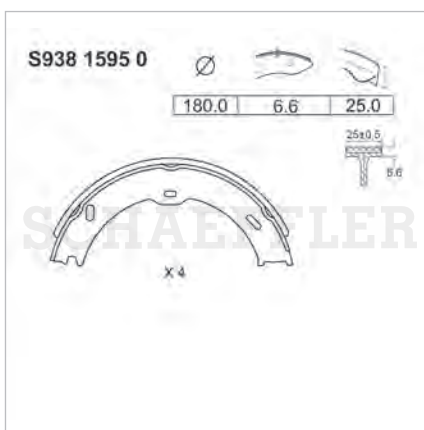
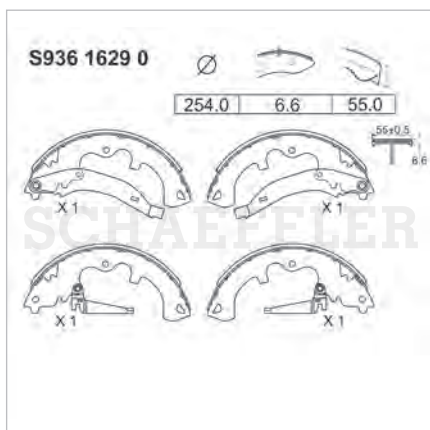
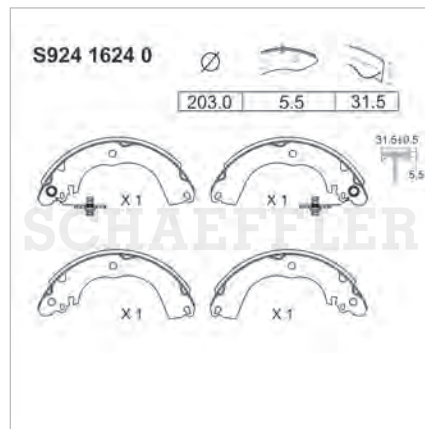
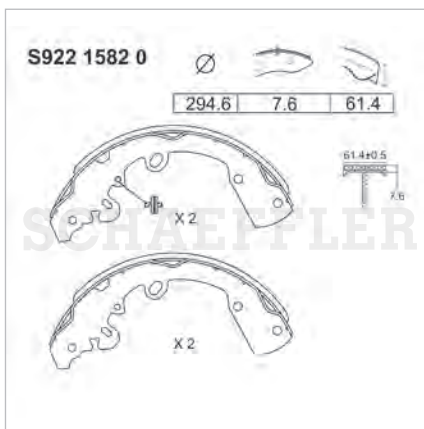
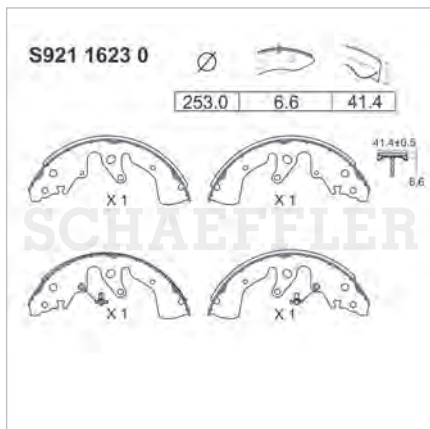

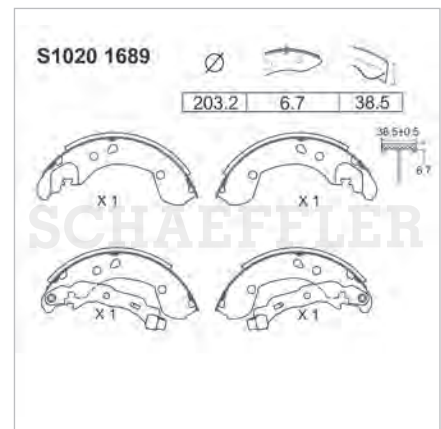
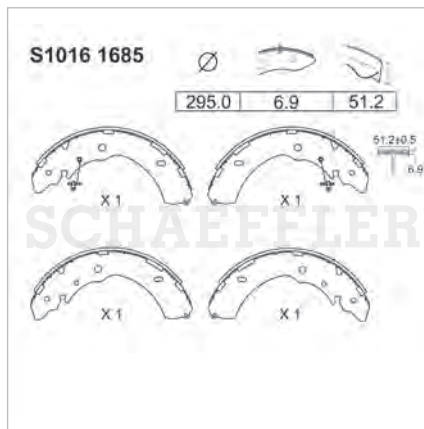
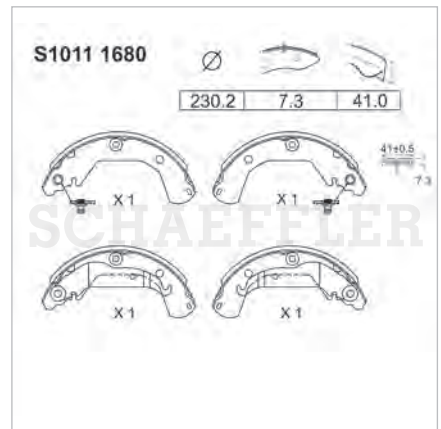
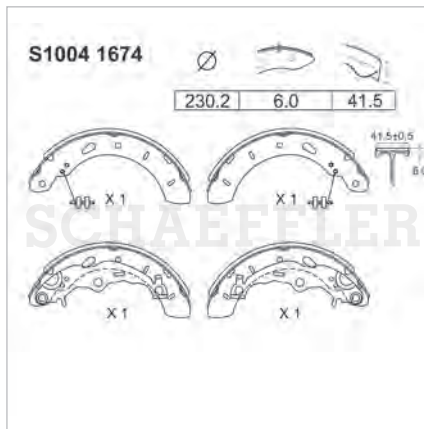
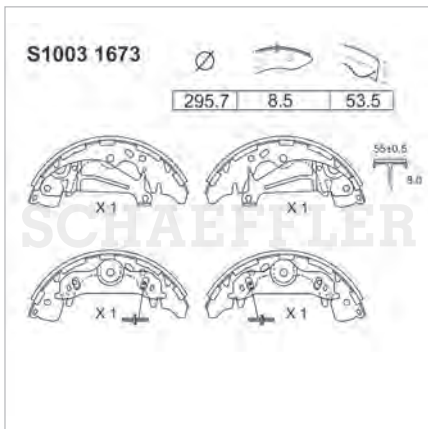
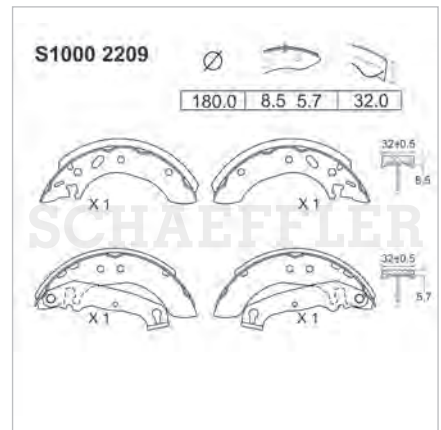
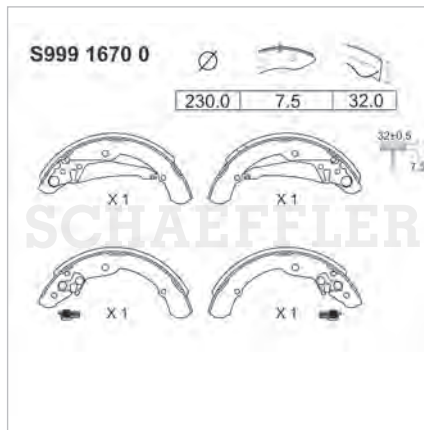
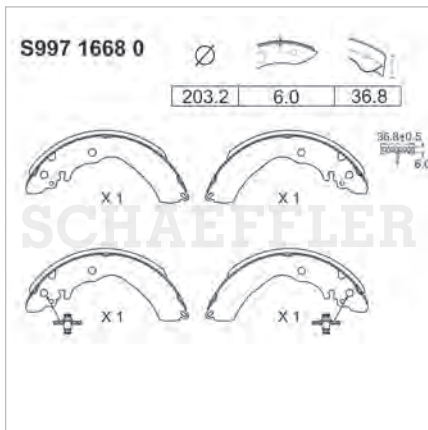
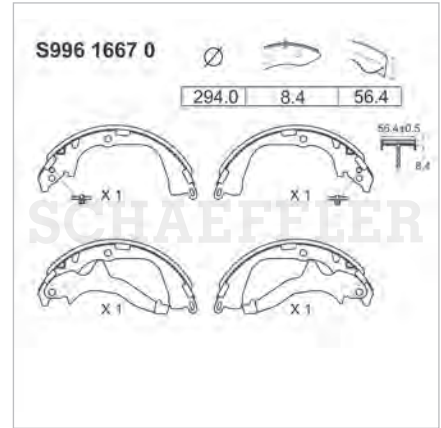
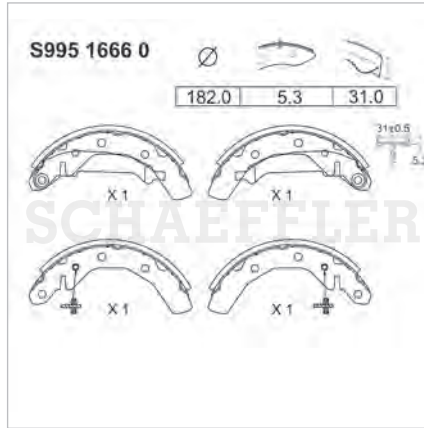
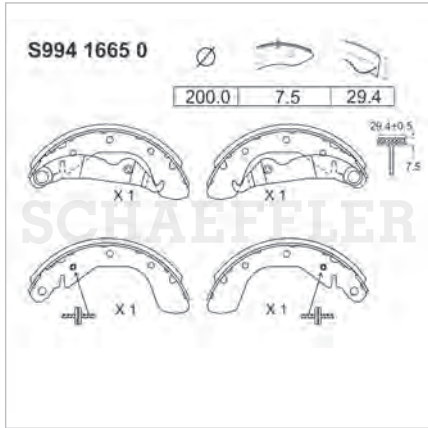

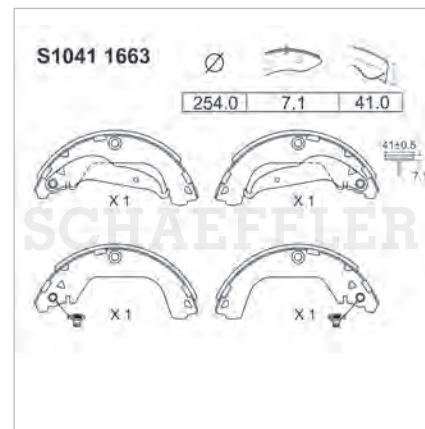
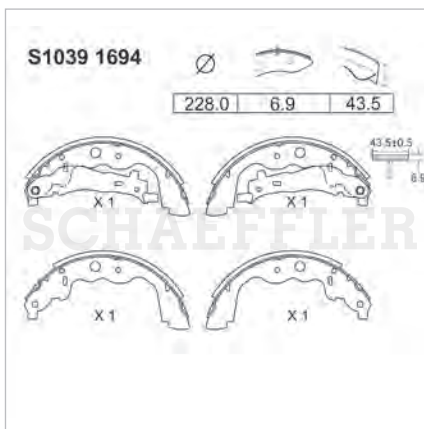
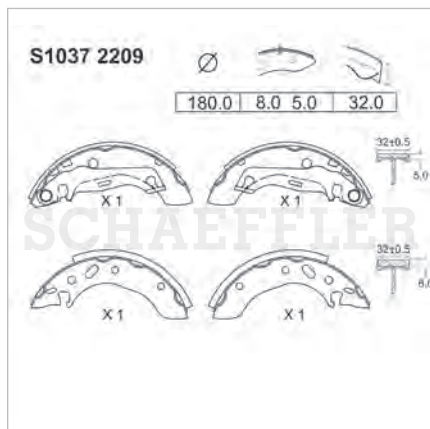
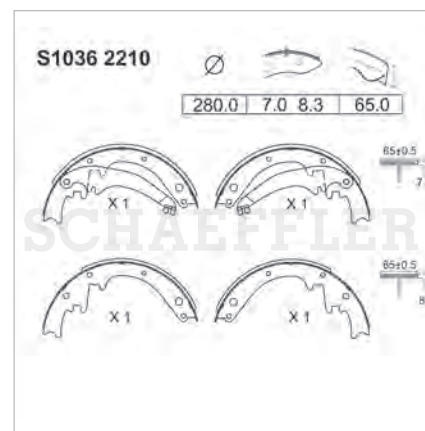
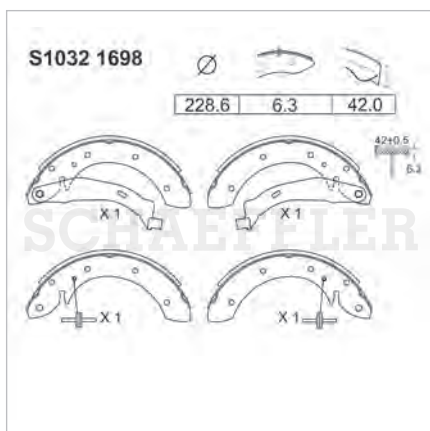
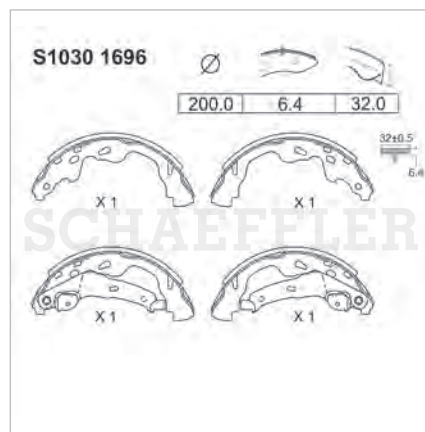
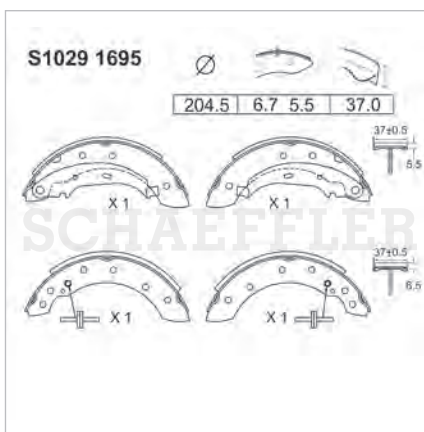
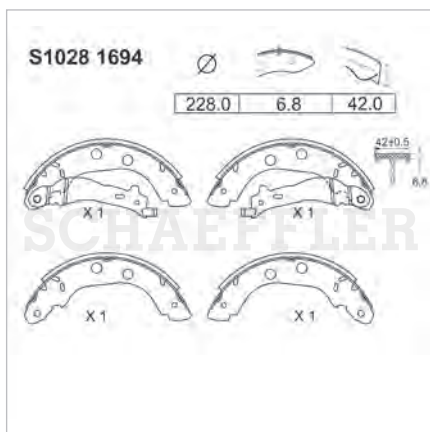
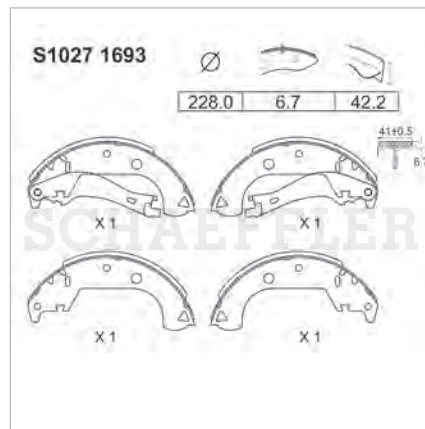
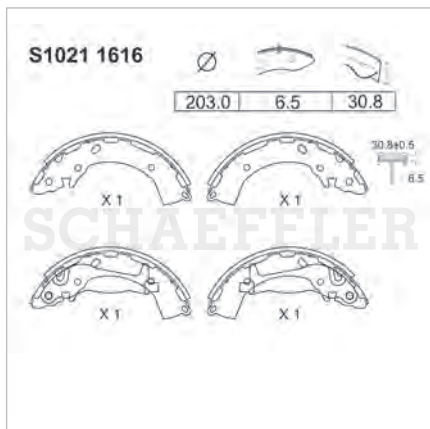

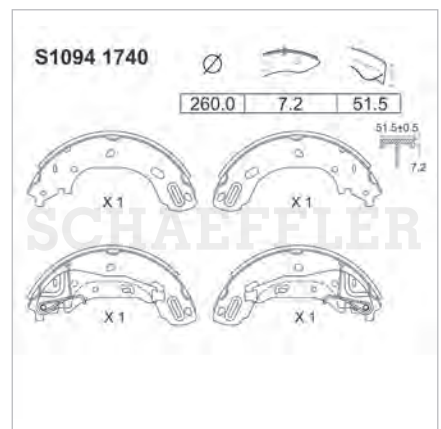
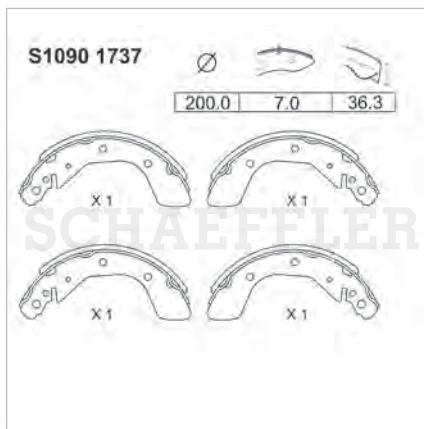
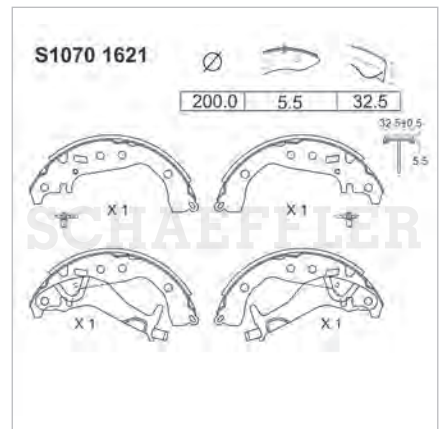
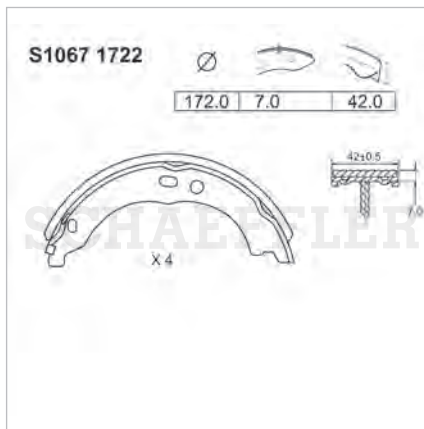
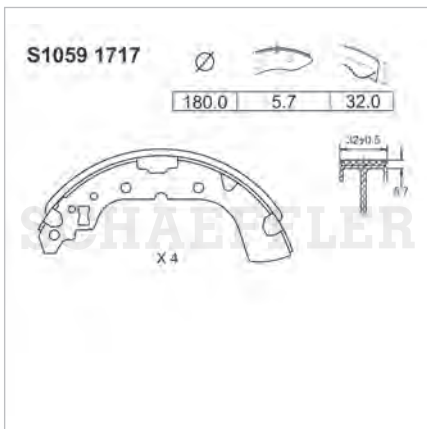
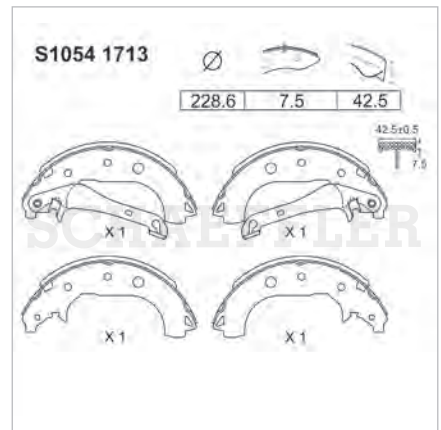
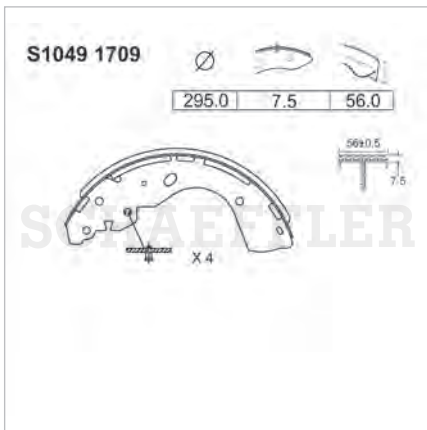
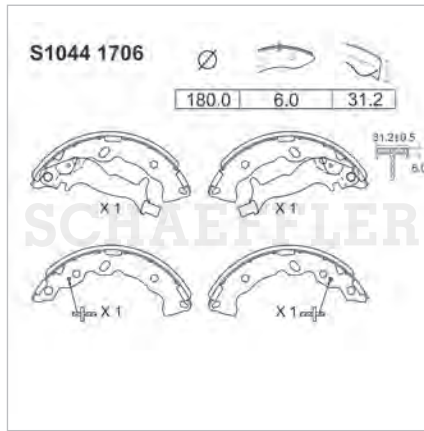
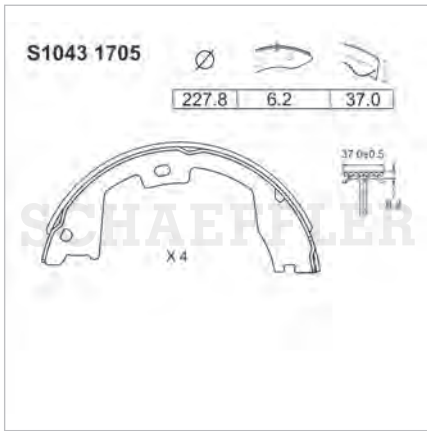

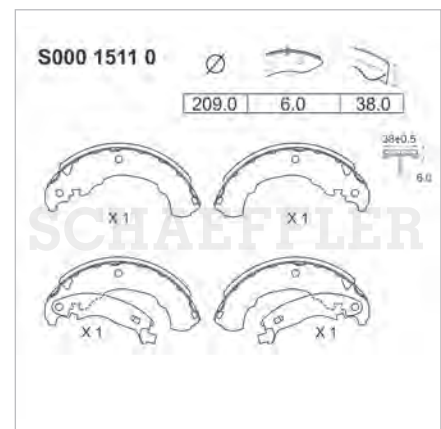
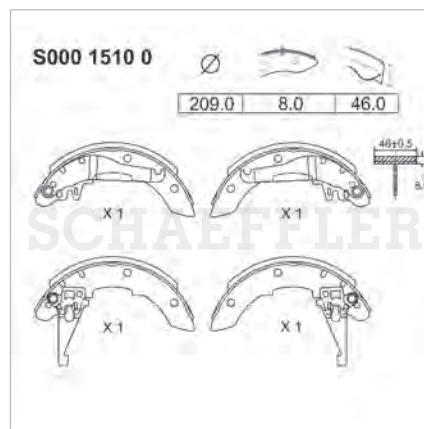
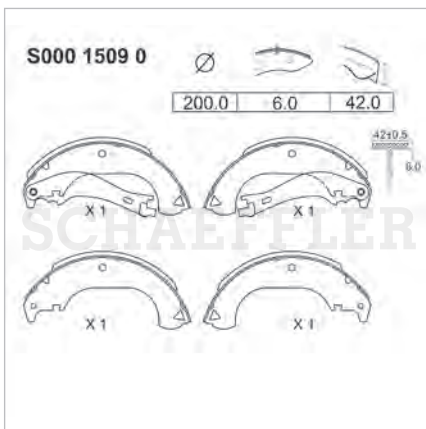
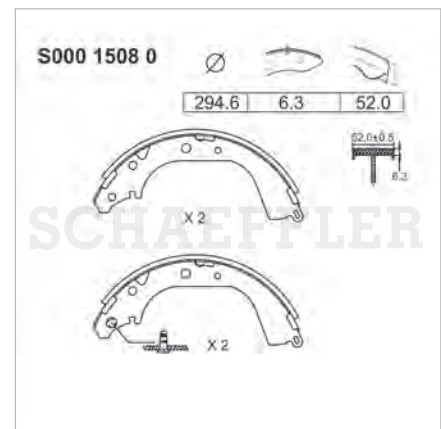
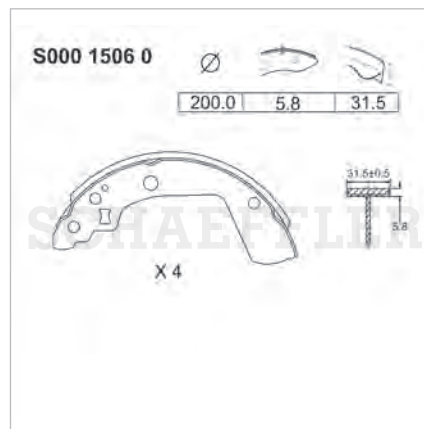
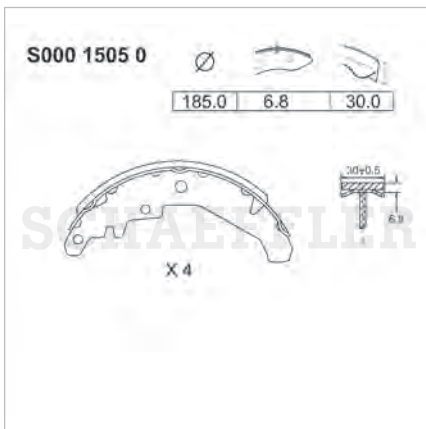
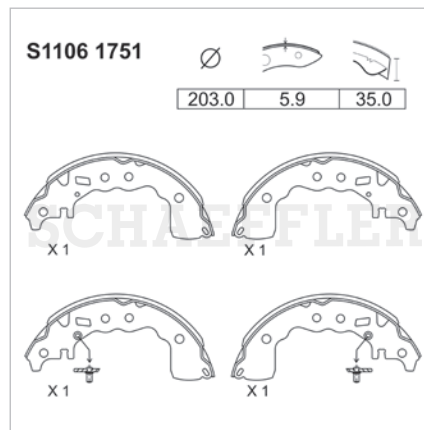
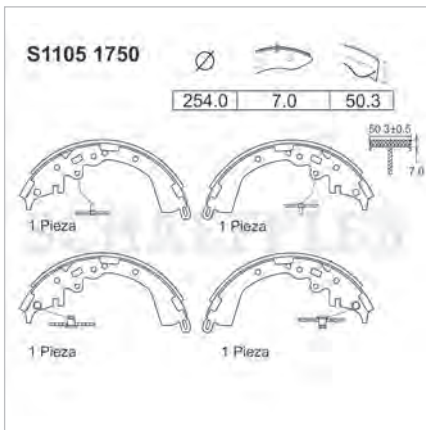
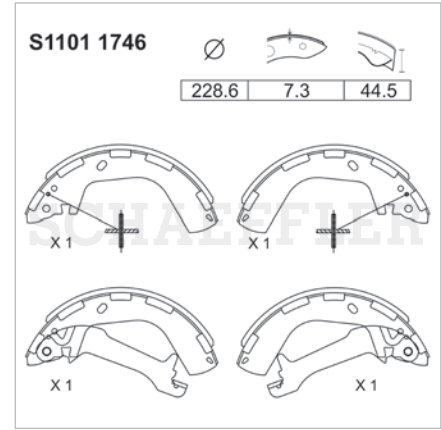
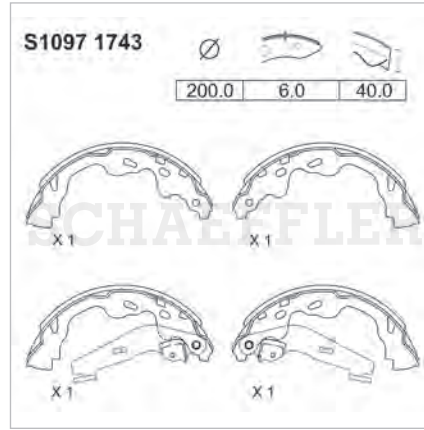
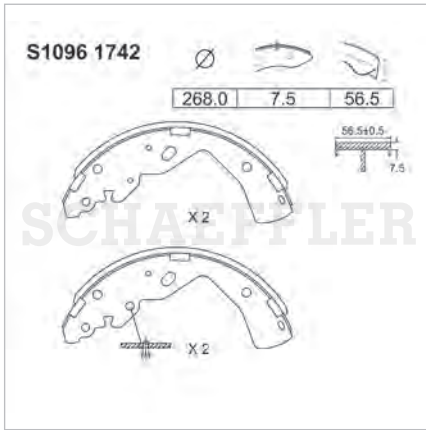

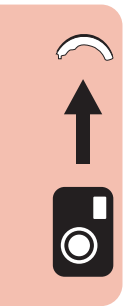
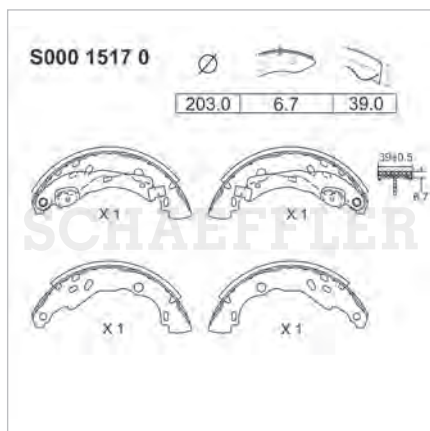

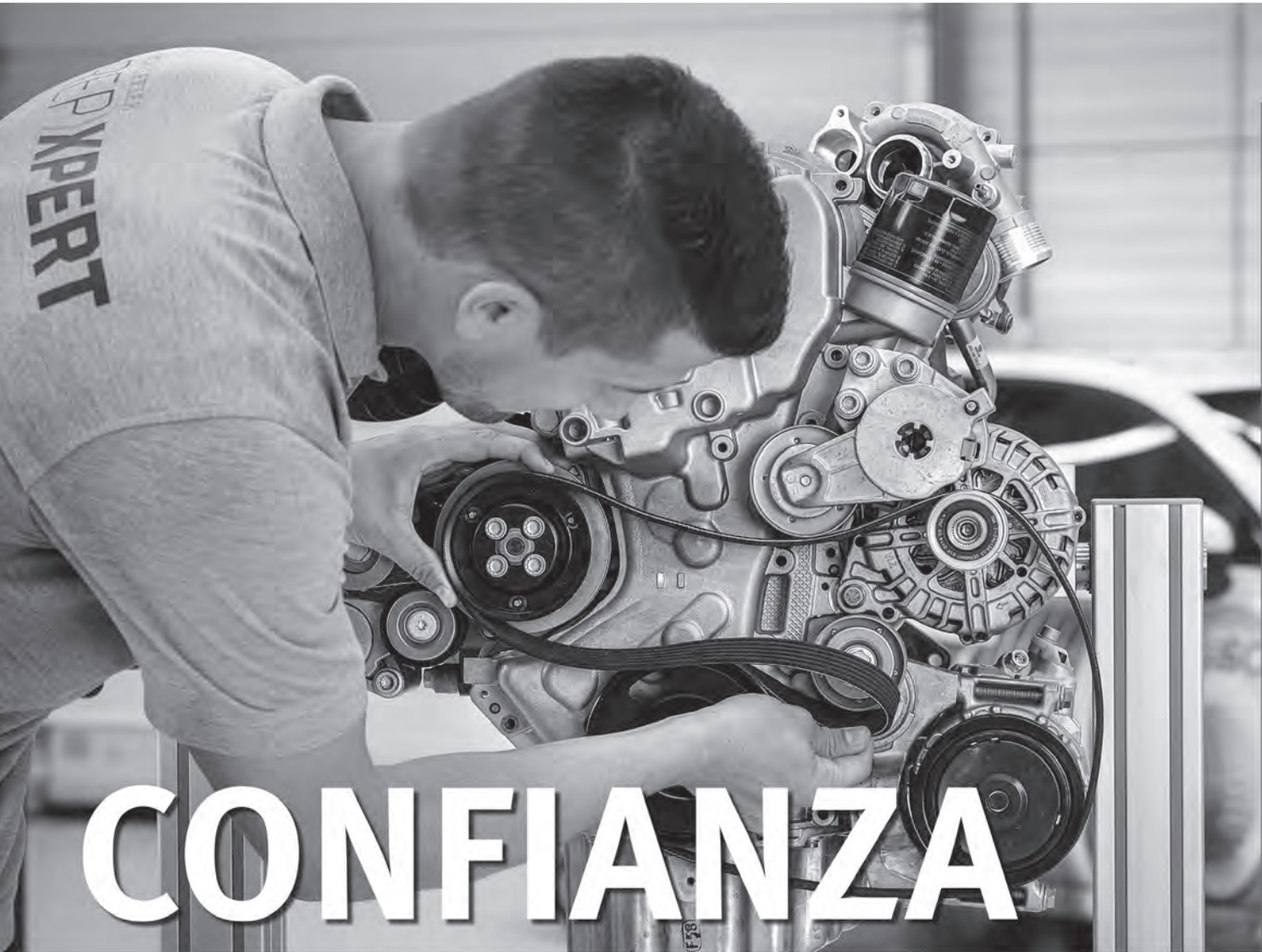

Calidad Schaeffler en LuK, INA, y FAG

Los componentes de LuK, INA y FAG brindan una de las gamas de producto para vehículos comerciales más completas. Las soluciones integrales de reparación le ahorran costos y tiempo.





¡Confíe en nosotros, LuK, INA y FAG le ofrecen más!











Lada 800 8000 585





Lu - Vi 9:00 - 18:00

www.repxpert.mx

BFR110110				BFR110410				BFR110610				BFR110910			
A	B	C	D	A	B	C	D	A	B	C	D	A	B	C	D
Ventilado	281,0	28,0	25,3	Ventilado	282,0	23,0	21,4	Ventilado	300,0	30,0	28,4	Ventilado	260,0	24,0	22,4
															
E	F	G	H	E	F	G	H	E	F	G	H	E	F	G	H
38,0	73,5	14,0	5	32,5	61,0	14,0	5	52,3	96,4	12,5	6	38,0	61,0	13,7	5





BFR111010				BFR111110				BFR111410				BFR111510			
A	B	C	D	A	B	C	D	A	B	C	D	A	B	C	D
Ventilado	256,0	22,0	20,0	Ventilado	328,3	30,0	28,5	Ventilado	294,0	26,0	24,4	Ventilado	257,0	20,2	18,4
															
E	F	G	H	E	F	G	H	E	F	G	H	E	F	G	H
46,7,0	62,0	12,5	4	53,0	72,0	16,4	5	45,7	69,0	14,0	5	38,3	61,0	14,0	5





BFR111610				BFR111710				BFR111910				BFR112310			
A	B	C	D	A	B	C	D	A	B	C	D	A	B	C	D
Ventilado	260,0	23,0	21,4	Ventilado	302,0	28,0	26,4	Ventilado	276,0	26,4	24,4	Ventilado	299,0	31,6	30,0
															
E	F	G	H	E	F	G	H	E	F	G	H	E	F	G	H
32,2	61,0	13,7	5	55,0	72,0	16,6	5	45,5	69,0	13,0	5	126,0		1/2"X20	5





BFR112510				BFR112610				BFR112710				BFR112910			
A	B	C	D	A	B	C	D	A	B	C	D	A	B	C	D
Ventilado	287,0	24,0	22,6	Ventilado	282,0	24,0	22,4	Ventilado	280,0	24,2	22,4	Ventilado	327,0	35,5	33,5
															
E	F	G	H	E	F	G	H	E	F	G	H	E	F	G	H
110,0		1/2"X20	6	38,0	73,5	13,9	5	81,3	71,8	15,6	5	102,0	122,2	17,0	8





A: Tipo
 B: Diámetro
 C: Espesor Nominal
 D: Espesor Mínimo
 E: Altura
 F: Diámetro Piloto
 G: Diámetro de Birlo o Barreno
 H: Número de Birlos o Barrenos



BFR113010				BFR113210				BFR113310				BFR113410			
A	B	C	D	A	B	C	D	A	B	C	D	A	B	C	D
Ventilado	295,0	32,5	30,8	Ventilado	344,8	28,2	26,5	Ventilado	287,0	24,1	22,6	Ventilado	282,0	24,0	22,4
															
E	F	G	H	E	F	G	H	E	F	G	H	E	F	G	H
113,5		1/2"X20	5	55,0	72,6	17,0	5	64,3	73,5	13,8	6	38,0	73,5	13,8	5





BFR113510				BFR113610				BFR113710				BFR113810			
A	B	C	D	A	B	C	D	A	B	C	D	A	B	C	D
Ventilado	320,0	28,2	26,5	Ventilado	360,0	32,0	30,0	Sólido	230,0	11,0	9,4	Ventilado	280,0	23,3	21,4
															
E	F	G	H	E	F	G	H	E	F	G	H	E	F	G	H
54,6	72,4	16,8	5	58,0	72,6	16,5	5	43,7	67,4	12,2	4	39,0	61,0	14,0	5





BFR114010				BFR114210				BFR114410				BFR114610			
A	B	C	D	A	B	C	D	A	B	C	D	A	B	C	D
Ventilado	305,4	25,9	24,5	Ventilado	257,0	22,0	20,4	Ventilado	281,0	28,0	25,3	Ventilado	256,0	22,0	20,0
															
E	F	G	H	E	F	G	H	E	F	G	H	E	F	G	H
64,0	71,8	15,3	5	38,0	61,0	14,0	5	38,0	73,5	14,0	5	44,0	62,2	12,5	4





BFR114710				BFR114810				BFR114910				BFR115010			
A	B	C	D	A	B	C	D	A	B	C	D	A	B	C	D
Ventilado	303,5	30,0	28,4	Ventilado	302,0	28,0	26,4	Ventilado	288,0	28,2	26,0	Ventilado	234,0	18,2	16,0
															
E	F	G	H	E	F	G	H	E	F	G	H	E	F	G	H
70,0	80,0	15,8	5	38,0	72,5	14,0	5	64,6	71,8	15,5	5	51,0	62,2	12,4	4





© Schaeffler Automotive Aftermarket México S. de R.L. de C.V. se reserva todos y cada uno de los derechos sobre las fotografías exclusivas de la marca aquí presentadas; se prohíbe la reproducción parcial y/o total, uso, modificación y distribución de cada una de estas fotografías

BFR115110				BFR115310				BFR115410				BFR115610			
A	B	C	D	A	B	C	D	A	B	C	D	A	B	C	D
Ventilado	253.0	20.0	18.4	Ventilado	336.2	28.0	26.4	Ventilado	305.0	28.0	26.0	Ventilado	241.0	19.0	17.0
															
E	F	G	H	E	F	G	H	E	F	G	H	E	F	G	H
28.0	83.9	10.5	5	68.0	78.5	17.0	5	39.7	70.0	16.6	5	52.0	62.2	12.5	4



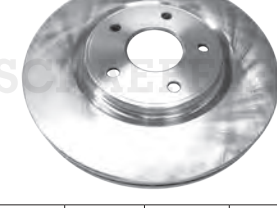

BFR115710				BFR115810				BFR115910				BFR116010			
A	B	C	D	A	B	C	D	A	B	C	D	A	B	C	D
Ventilado	241.0	18.0	16.0	Ventilado	251.0	17.0	15.4	Ventilado	353.0	35.6	33.5	Ventilado	280.0	24.0	22.7
															
E	F	G	H	E	F	G	H	E	F	G	H	E	F	G	H
49.0	62.2	12.8	4	41.8	64.0	12.5	4	101.8	122.2	16.8	8	78.0	72.0	16.0	5





BFR116210				BFR116410				BFR116510				BFR116610			
A	B	C	D	A	B	C	D	A	B	C	D	A	B	C	D
Ventilado	274.0	26.0	24.4	Ventilado	312.0	28.0	26.0	Ventilado	330.0	28.0	26.4	Ventilado	330.0	32.0	30.5
															
E	F	G	H	E	F	G	H	E	F	G	H	E	F	G	H
44.0	87.0	10.5	5	66.0	78.5	16.5	5	39.8	70.0	15.4	5	55.0	72.0	17.0	5





BFR116710				BFR116810				BFR117010				BFR117110			
A	B	C	D	A	B	C	D	A	B	C	D	A	B	C	D
Ventilado	302.0	28.0	26.4	Ventilado	360.0	39.0	37.4	Ventilado	350.0	32.0	30.5	Ventilado	330.0	28.0	26.4
															
E	F	G	H	E	F	G	H	E	F	G	H	E	F	G	H
64.0	72.0	16.6	5	102.0	123.0	16.7	8	54.8	72.2	17.0	5	39.0	72.5	14.5	5





A: Tipo
 B: Diámetro
 C: Espesor Nominal
 D: Espesor Mínimo
 E: Altura
 F: Diámetro Piloto
 G: Diámetro de Birlo o Barreno
 H: Número de Birlos o Barrenos



BFR117310				BFR120110				BFR120210				BFR120310			
A	B	C	D	A	B	C	D	A	B	C	D	A	B	C	D
Ventilado	300.0	32.0	30.0	Ventilado	235.0	24.5	22.4	Ventilado	302.8	26.0	24.0	Ventilado	293.0	30.0	28.4
															
E	F	G	H	E	F	G	H	E	F	G	H	E	F	G	H
73.7	80.0	17.6	5	57.0	63.5	14.0	4	46.7	71.8	14.2	5	49.0	71.0	14.7	5





BFR120510				BFR120910				BFR121010				BFR122010			
A	B	C	D	A	B	C	D	A	B	C	D	A	B	C	D
Ventilado	305.0	26.0	24.5	Ventilado	330.0	30.0	28.5	Ventilado	305.0	26.2	24.5	Ventilado	260.0	24.0	22.2
															
E	F	G	H	E	F	G	H	E	F	G	H	E	F	G	H
56.3	82.0	14.0	5	92.2		M14X2	6	65.5	72.0	15.8	5	47.0	63.6	13.9	4



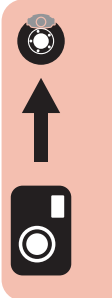

BFR122210				BFR122510				BFR122810				BFR123110			
A	B	C	D	A	B	C	D	A	B	C	D	A	B	C	D
Ventilado	275.5	26.02	24.7	Ventilado	320.0	32.0	30.0	Ventilado	261.5	22.2	20.1	Ventilado	320.0	28.0	26.0
															
E	F	G	H	E	F	G	H	E	F	G	H	E	F	G	H
47.0	70.90	14.0	5	93.0	91.0	13.4	8	105.0		1/2"X20	5	48.5	72.0	14.0	5





BFR123310				BFR123410				BFR123710				BFR123810			
A	B	C	D	A	B	C	D	A	B	C	D	A	B	C	D
Ventilado	276.0	22.6	20.4	Ventilado	261.0	22.2	20.6	Ventilado	261.5	22.2	20.6	Ventilado	298.0	26.0	24.5
															
E	F	G	H	E	F	G	H	E	F	G	H	E	F	G	H
63.5	77.7	1/2"X20	5	105.5		1/2"X20	5	105.5		1/2"X20	5	133.5		1/2"X20	5





© Schaeffler Automotive Aftermarket México S. de R.L. de C.V. se reserva todos y cada uno de los derechos sobre las fotografías exclusivas de la marca aquí presentadas; se prohíbe la reproducción parcial y/o total, uso, modificación y distribución de cada una de estas fotografías



BFR123910				BFR124010				BFR124110				BFR124210			
A	B	C	D	A	B	C	D	A	B	C	D	A	B	C	D
Ventilado	298.0	26.0	24.4	Ventilado	331.0	30.0	28.0	Ventilado	331.0	30.0	28.0	Ventilado	331.0	30.0	28.0
															
E	F	G	H	E	F	G	H	E	F	G	H	E	F	G	H
133.4	86.4	1/2"X20	5	206.0		14.1X18	8	143.0		14.1X18	8	143.0		M14X1.5	8



BFR124310				BFR124410				BFR124610				BFR124710			
A	B	C	D	A	B	C	D	A	B	C	D	A	B	C	D
Ventilado	350.0	34.0	32.0	Ventilado	261.0	26.4	24.5	Ventilado	287.0	26.3	24.5	Ventilado	308.0	26.3	24.7
															
E	F	G	H	E	F	G	H	E	F	G	H	E	F	G	H
49.5	90.0	16.0	6	109.4	63.5	1/2"X20	5	108.0		1/2"X20	5	104.5	86.7	M14X2	5





BFR124810				BFR124910				BFR125010				BFR125110			
A	B	C	D	A	B	C	D	A	B	C	D	A	B	C	D
Ventilado	308.0	26.0	24.7	Ventilado	308.0	30.0	27.7	Ventilado	308.0	26.2	24.7	Ventilado	308.0	30.0	27.7
															
E	F	G	H	E	F	G	H	E	F	G	H	E	F	G	H
105.7		M12X1.75	5	47.0	92.2	15.0	5	104.3		M12X1.75	5	103.0	86.7	M12X1.75	5





BFR125410				BFR125610				BFR125710				BFR126010			
A	B	C	D	A	B	C	D	A	B	C	D	A	B	C	D
Ventilado	331.0	37.6	36.0	Ventilado	346.0	37.8	36.3	Ventilado	278.0	25.0	23.0	Ventilado	257.0	22.0	20.0
															
E	F	G	H	E	F	G	H	E	F	G	H	E	F	G	H
227.0		M14X2	8	100.0	129.0	16.0	8	45.4	63.5	14.2	4	45.0	55.0	12.9	4





A: Tipo
 B: Diámetro
 C: Espesor Nominal
 D: Espesor Mínimo
 E: Altura
 F: Diámetro Piloto
 G: Diámetro de Birlo o Barreno
 H: Número de Birlos o Barrenos







BFR126110				BFR126210				BFR126310				BFR126410			
A	B	C	D	A	B	C	D	A	B	C	D	A	B	C	D
Ventilado	239.5	20.0	18.0	Sólido	240.0	12.0	10.0	Ventilado	258.0	22.0	20.0	Ventilado	298.0	30.0	28.5
															
E	F	G	H	E	F	G	H	E	F	G	H	E	F	G	H
43.0	63.5	14.0	4	43.0	63.5	13.7	4	43.3	63.5	13.6	4	138.0		1/2"X20	5





BFR126610				BFR126710				BFR126810				BFR126910			
A	B	C	D	A	B	C	D	A	B	C	D	A	B	C	D
Ventilado	286.0	26.0	24.5	Ventilado	281.4	26.2	24.7	Ventilado	347.0	38.0	36.0	Ventilado	300.0	24.0	22.0
															
E	F	G	H	E	F	G	H	E	F	G	H	E	F	G	H
66.0	72.0	15.8	5	46.3	71.0	14.0	5	214.0		M14X1.5	8	47.2	63.5	13.5	5





BFR127110				BFR127310				BFR127410				BFR127810			
A	B	C	D	A	B	C	D	A	B	C	D	A	B	C	D
Ventilado	347.0	38.3	36.4	Vent	308.0	31.0	28.0	Ventilado	278.0	24.0	22.0	Ventilado	258.0	22.0	20.0
															
E	F	G	H	E	F	G	H	E	F	G	H	E	F	G	H
213.1	142.0	M14X1.5	8	61.0	93.0	M12X1.5	5	213.1	142.0	M14X1.5	8	43.4	63.6	14.0	4





BFR128010				BFR128110				BFR128210				BFR128810			
A	B	C	D	A	B	C	D	A	B	C	D	A	B	C	D
Ventilado	300.5	26.2	24.5	Ventilado	308.0	33.0	30.0	Ventilado	330.5	30.0	27.0	Ventilado	298.0	25.0	23.0
															
E	F	G	H	E	F	G	H	E	F	G	H	E	F	G	H
108.4		1/2"X20	5	55.5	93.0	M10X1.5	5	49.0	90.0	16.6	6	48.5	72.0	13.0	5



BFR129010				BFR129510				BFR129710				BFR129910			
A	B	C	D	A	B	C	D	A	B	C	D	A	B	C	D
Ventilado	288.0	33.0	30.0	Ventilado	278.0	25.0	23.0	Ventilado	316.0	30.0	28.4	Ventilado	304.6	30.0	28.5
															
E	F	G	H	E	F	G	H	E	F	G	H	E	F	G	H
55.5	93.0	M10-6H	5	40.0	63.5	13.7	0	48.0	71.0	15.3	5	54.0	82.0	14.0	5





BFR130410				BFR131110				BFR131710				BFR131810			
A	B	C	D	A	B	C	D	A	B	C	D	A	B	C	D
Ventilado	267.0	26.5	24.5	Ventilado	259.0	20.3	18.7	Ventilado	278.0	26.0	24.7	Ventilado	278.0	32.0	30.7
															
E	F	G	H	E	F	G	H	E	F	G	H	E	F	G	H
106.5	70.6	M12X1.5	5	48.0	58.4	13.9	5	49.3	70.5	16.3	5	52.0	70.7	16.1	5





BFR132110				BFR132410				BFR132510				BFR132610			
A	B	C	D	A	B	C	D	A	B	C	D	A	B	C	D
Ventilado	301.5	32.6	30.8	Ventilado	296.5	26.0	23.0	Ventilado	296.5	26.2	24.2	Ventilado	295.0	32.8	30.0
															
E	F	G	H	E	F	G	H	E	F	G	H	E	F	G	H
125.0	77.9	1/2"X20	5	43.9	65.7	14.0	5	106.4		9/16"X18	5	114.6		M14x1.5	5





BFR132710				BFR132910				BFR133010				BFR133110			
A	B	C	D	A	B	C	D	A	B	C	D	A	B	C	D
Ventilado	266.7	26.3	24.5	Ventilado	295.5	32.8	30.9	Ventilado	317.0	32.7	30.8	Ventilado	351.0	37.0	34.7
															
E	F	G	H	E	F	G	H	E	F	G	H	E	F	G	H
109.6		M12X1.5	5	114.5	77.7	M14x1.5	5	125.9	116.5	M14x1.5	8	74.6	127.2	16.5	5





A: Tipo
 B: Diámetro
 C: Espesor Nominal
 D: Tipo
 E: Altura
 F: Diámetro Piloto
 G: Diámetro de Birlo o Barreno
 H: Número de Birlos o Barrenos



BFR133310				BFR133410				BFR133610				BFR133710			
A	B	C	D	A	B	C	D	A	B	C	D	A	B	C	D
Ventilado	275.0	29.0	27.5	Ventilado	236.0	20.0	18.5	Ventilado	257.4	22.2	20.6	Sólido	290.0	10.0	8.0
															
E	F	G	H	E	F	G	H	E	F	G	H	E	F	G	H
54.8	70.6	12.7	5	41.0	60.0	14.5	4	36.2	87.9	M12X1.25	6	46.0	107.0	12.5	5





BFR133910				BFR134010				BFR134310				BFR134410			
A	B	C	D	A	B	C	D	A	B	C	D	A	B	C	D
Ventilado	256.0	24.0	21.0	Ventilado	280.0	25.0	22.0	Ventilado	260.0	24.0	21.0	Ventilado	304.5	29.0	27.2
															
E	F	G	H	E	F	G	H	E	F	G	H	E	F	G	H
41.0	60.0	14.3	4	42.0	70.0	14.0	5	41.0	60.0	14.6	4	58.0	78.5	16.0	6



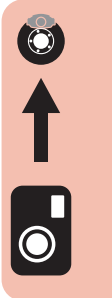

BFR134510				BFR134610				BFR134810				BFR135110			
A	B	C	D	A	B	C	D	A	B	C	D	A	B	C	D
Ventilado	374.6	34.3	31.1	Ventilado	275.0	30.0	27.0	Sólido	236.0	12.5	9.7	Ventilado	286.0	17.0	15.0
															
E	F	G	H	E	F	G	H	E	F	G	H	E	F	G	H
97.2	137.1	17.0	5	52.5	71.0	14.3	5	35.5	86.0	M10X1.25	4	29.0	108.5	12.5	5





BFR135210				BFR135310				BFR135510				BFR135610			
A	B	C	D	A	B	C	D	A	B	C	D	A	B	C	D
Ventilado	305.0	29.0	27.5	Ventilado	325.5	29.3	27.5	Ventilado	296.0	26.2	24.5	Ventilado	280.0	27.5	25.6
															
E	F	G	H	E	F	G	H	E	F	G	H	E	F	G	H
55.0	79.0	13.0	6	54.0	79.0	16.2	6	51.7	70.6	13.4	5	40.0	92.0	12.2	6



© Schaeffler Automotive Aftermarket México S. de R.L. de C.V. se reserva todos y cada uno de los derechos sobre las fotografías exclusivas de la marca aquí presentadas; se prohíbe la reproducción parcial y/o total, uso, modificación y distribución de cada una de estas fotografías



BFR136010				BFR136210				BFR136410				BFR136510			
A	B	C	D	A	B	C	D	A	B	C	D	A	B	C	D
Ventilado	296.0	30.0	27.0	Ventilado	324.8	38.0	36.6	Ventilado	276.0	26.0	23.0	Ventilado	255.5	24.0	22.0
															
E	F	G	H	E	F	G	H	E	F	G	H	E	F	G	H
51.0	67.5	16.2	5	89.2	118.1	16.5	8	43.4	65.8	14.2	5	47.0	60.2	12.6	4





BFR136710				BFR136910				BFR137110				BFR137210			
A	B	C	D	A	B	C	D	A	B	C	D	A	B	C	D
Ventilado	256.0	24.0	22.0	Ventilado	297.0	32.0	30.7	Ventilado	296.0	29.0	27.4	Ventilado	325.3	29.0	27.5
															
E	F	G	H	E	F	G	H	E	F	G	H	E	F	G	H
47.0	60.0	14.0	4	52.6	70.0	14.6	6	51.6	70.7	12.7	5	54.5	75.5	15.7	6





BFR137310				BFR137410				BFR137510				BFR137910			
A	B	C	D	A	B	C	D	A	B	C	D	A	B	C	D
Ventilado	330.0	30.0	28.0	Ventilado	256.0	24.0	22.0	Ventilado	276.0	26.0	23.0	Ventilado	280.0	24.0	22.0
															
E	F	G	H	E	F	G	H	E	F	G	H	E	F	G	H
55.5	78.7	16.3	6	40.0	60.0	12.6	4	43.0	65.7	14.0	5	41.6	60.0	15.0	4





BFR138210				BFR138510				BFR139010				BFR139110			
A	B	C	D	A	B	C	D	A	B	C	D	A	B	C	D
Ventilado	298.0	29.0	27.5	Ventilado	321.3	30.0	27.0	Ventilado	275.8	26.0	23.0	Vent	300.0	26.0	23.0
												Imagen no disponible			
E	F	G	H	E	F	G	H	E	F	G	H	E	F	G	H
40.0	92.2	M12X1.5	6	51.0	67.5	16.2	5	45.6	60.0	14.3	5	45.5	70.8	14.3	5





A: Tipo
 B: Diámetro
 C: Espesor Nominal
 D: Tipo
 E: Espesor Mínimo
 F: Diámetro Piloto
 G: Diámetro de Birlo o Barreno
 H: Número de Birlos o Barrenos



BFR139410				BFR139610				BFR139910				BFR220110			
A	B	C	D	A	B	C	D	A	B	C	D	A	B	C	D
Ventilado	354.0	40.0	38.5	Ventilado	279.6	25.0	22.0	Ventilado	256.0	24.0	21.0	Ventilado	325.7	31.5	29.2
															
E	F	G	H	E	F	G	H	E	F	G	H	E	F	G	H
102.3	127.1	16.4	8	42.0	60.0	15.0	4	45.5	60.0	12.5	4	125.0		15.2	5



BFR220210				BFR220410				BFR220610				BFR220710			
A	B	C	D	A	B	C	D	A	B	C	D	A	B	C	D
Ventilado	302.0	32.0	30.0	Ventilado	369.0	38.0	36.0	Ventilado	370.0	39.0	37.4	Ventilado	300.0	28.0	24.0
															
E	F	G	H	E	F	G	H	E	F	G	H	E	F	G	H
60.0	98.0	15.0	6	97.8	129.2	16.5	8	98.5	129.0	16.0	10	54.4	93.0	M10X1.5	5



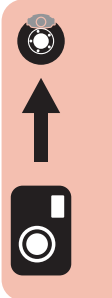

BFR220910				BFR221110				BFR221410				BFR221510			
A	B	C	D	A	B	C	D	A	B	C	D	A	B	C	D
Ventilado	345.0	40.0	38.4	Ventilado	258.0	23.0	21.0	Ventilado	307.8	30.0	27.7	Ventilado	330.0	30.0	28.5
															
E	F	G	H	E	F	G	H	E	F	G	H	E	F	G	H
144.0	0.0	14.0	8	44.0	63.5	13.0	4	102.8		M14X2	5	54.6	90.0	15.8	6





BFR221610				BFR221710				BFR221810				BFR221910			
A	B	C	D	A	B	C	D	A	B	C	D	A	B	C	D
Ventilado	278.0	25.0	23.0	Ventilado	325.7	30.0	28.5	Ventilado	280.0	28.0	24.0	Ventilado	300.0	28.0	26.5
															
E	F	G	H	E	F	G	H	E	F	G	H	E	F	G	H
48.5	63.5	13.6	5	47.0	68.0	14.5	5	54.5	93.0	M10X1.5	5	51.0	63.6	13.8	5





© Schaeffler Automotive Aftermarket México S. de R.L. de C.V. se reserva todos y cada uno de los derechos sobre las fotografías exclusivas de la marca aquí presentadas; se prohíbe la reproducción parcial y/o total, uso, modificación y distribución de cada una de estas fotografías



BFR222610				BFR230010				BFR230110				BFR230410			
A	B	C	D	A	B	C	D	A	B	C	D	A	B	C	D
Ventilado	363.0	38.0	36.4	Ventilado	236.0	20.0	18.0	Ventilado	300.0	27.0	25.0	Ventilado	256.0	22.0	20.0
				use BFR133410											
E	F	G	H	E	F	G	H	E	F	G	H	E	F	G	H
213.6		14X1.5	8	41.0	59.0	12.8	4	40.0	88.0	M12X1.25	6	40.5	59.0	12.9	4





BFR231310				BFR231410				BFR231510				BFR232210			
A	B	C	D	A	B	C	D	A	B	C	D	A	B	C	D
Ventilado	310.0	27.0	25.0	Ventilado	236.0	20.0	18.0	Ventilado	300.0	26.0	23.0	Ventilado	276.0	26.0	23.0
															
E	F	G	H	E	F	G	H	E	F	G	H	E	F	G	H
61.0	71.0	15.9	6	41.0	60.0	12.7	4	46.2	60.0	14.5	5	45.5	60.0	14.0	5





BFR232310				BFR232410				BFR320110				BFR320310			
A	B	C	D	A	B	C	D	A	B	C	D	A	B	C	D
Ventilado	276.0	22.0	20.0	Ventilado	343.0	30.0	28.0	Ventilado	332.0	30.0	28.4	Ventilado	300.0	22.0	20.4
															
E	F	G	H	E	F	G	H	E	F	G	H	E	F	G	H
43.7	60.0	14.0	5	58.5	78.6	16.0	6	62.0	75.0	16.7	5	51.5	79.0	14.4	5



BFR320510				BFR320610				BFR320810				BFR321810			
A	B	C	D	A	B	C	D	A	B	C	D	A	B	C	D
Ventilado	280.0	22.0	20.4	Ventilado	294.0	22.0	20.4	Ventilado	276.0	22.0	20.4	Ventilado	325.0	25.0	23.4
															
E	F	G	H	E	F	G	H	E	F	G	H	E	F	G	H
44.0	64.0	16.2	4	44.0	64.0	16.2	4	44.0	64.2	15.0	4	62.7	75.0	16.6	5





A: Tipo
 B: Diámetro
 C: Espesor Nominal
 D: Espesor Mínimo
 E: Altura
 F: Diámetro Piloto
 G: Diámetro de Birlo o Barreno
 H: Número de Birlos o Barrenos



BFR323110				BFR323710				BFR340110				BFR340210			
A	B	C	D	A	B	C	D	A	B	C	D	A	B	C	D
Ventilado	300.0	24.0	22.4	Ventilado	292.0	21.0	20.4	Ventilado	276.0	22.0	19.0	Ventilado	284.7	22.0	19.0
															
E	F	G	H	E	F	G	H	E	F	G	H	E	F	G	H
73.8	79.0	14.8	5	72.6	79.0	15.0	5	77.0	85.0	15.0	5	72.0	85.0	15.0	5





BFR343910				BFR345710				BFR350210				BFR350510			
A	B	C	D	A	B	C	D	A	B	C	D	A	B	C	D
Ventilado	300.0	28.0	25.0	Ventilado	290.0	26.0	23.0	Ventilado	280.0	24.0	22.0	Ventilado	280.0	24.0	21.8
															
E	F	G	H	E	F	G	H	E	F	G	H	E	F	G	H
68.5	85.0	15.5	6	70.0	70.0	14.5	8	44.0	68.0	15.7	5	44.0	61.0	13.4	4



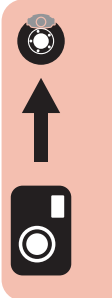

BFR350610				BFR350910				BFR351010				BFR360110			
A	B	C	D	A	B	C	D	A	B	C	D	A	B	C	D
Ventilado	259.0	21.0	17.7	Ventilado	258.0	22.0	19.8	Ventilado	238.0	17.0	15.0	Ventilado	256.0	20.0	18.0
				Imagen no disponible				Imagen no disponible							
E	F	G	H	E	F	G	H	E	F	G	H	E	F	G	H
41.0	61.0	13.5	4	44.0	61.0	13.5	4	41.0	61.0	13.6	3	38.7	65.0	13.5	4





BFR370110				BFR370310				BFR370410				BFR370510			
A	B	C	D	A	B	C	D	A	B	C	D	A	B	C	D
Sólido	239.5	12.0	10.0	Sólido	278.0	13.0	11.0	Ventilado	239.0	20.0	18.0	Ventilado	256.0	20.0	18.0
															
E	F	G	H	E	F	G	H	E	F	G	H	E	F	G	H
35.1	65.0	13.7	4	86.5	66.1	16.0	5	39.0	65.0	13.8	4	38.6	65.0	13.8	4





© Schaeffler Automotive Aftermarket México S. de R.L. de C.V. se reserva todos y cada uno de los derechos sobre las fotografías exclusivas de la marca aquí presentadas; se prohíbe la reproducción parcial y/o total, uso, modificación y distribución de cada una de estas fotografías



BFR370710				BFR370810				BFR370910				BFR371110			
A	B	C	D	A	B	C	D	A	B	C	D	A	B	C	D
Ventilado	280.0	22.0	19.0	Ventilado	320.0	30.0	28.0	Sólido	278.0	10.0	8.0	Sólido	256.5	13.0	11.0
															
E	F	G	H	E	F	G	H	E	F	G	H	E	F	G	H
36.5	65.0	15.6	5	52.3	68.0	15.2	5	56.5	80.0	15.8	4	40.0	65.0	13.4	4





BFR371210				BFR371310				BFR371410				BFR371610			
A	B	C	D	A	B	C	D	A	B	C	D	A	B	C	D
Ventilado	308.0	29.6	25.5	Ventilado	288.0	25.0	23.0	Sólido	282.0	18.0	15.0	Ventilado	256.0	22.0	20.0
															
E	F	G	H	E	F	G	H	E	F	G	H	E	F	G	H
56.0	76.0	16.5	5	34.0	65.0	15.0	5	55.5	68.0	16.5	5	36.8	65.0	16.0	5



BFR371710				BFR371810				BFR371910				BFR372210			
A	B	C	D	A	B	C	D	A	B	C	D	A	B	C	D
Ventilado	288.0	25.0	23.0	Ventilado	280.0	22.0	19.0	Ventilado	312.0	25.0	22.0	Ventilado	288.0	25.2	22.0
															
E	F	G	H	E	F	G	H	E	F	G	H	E	F	G	H
46.5	68.0	15.5	5	49.7	65.0	15.7	5	50.0	65.0	15.0	5	50.0	65.0	15.5	5





BFR372510				BFR374510				BFR375910				BFR376010			
A	B	C	D	A	B	C	D	A	B	C	D	A	B	C	D
Ventilado	344.5	30.0	27.0	Ventilado	256.0	18.0	16.0	Ventilado	313.0	26.0	24.0	Ventilado	340.0	30.0	27.0
															
E	F	G	H	E	F	G	H	E	F	G	H	E	F	G	H
50.0	65.0	15.5	5	34.0	65.0	14.2	4	56.0	68.2	16.5	5	49.7	65.0	15.3	5t



A: Tipo
 B: Diámetro
 C: Espesor Nominal
 D: Tipo
 E: Espesor Mínimo
 F: Diámetro Piloto
 G: Diámetro de Birlo o Barreno
 H: Número de Birlos o Barrenos



BFR376110				BFR377010				BFR377110				BFR377210			
A	B	C	D	A	B	C	D	A	B	C	D	A	B	C	D
Ventilado	302.0	28.0	26.0	Ventilado	256.0	22.0	20.0	Ventilado	332.0	30.0	27.0	Ventilado	256.0	22.0	19.0
															
E	F	G	H	E	F	G	H	E	F	G	H	E	F	G	H
57.0	76.0	16.5	5	36.8	65.0	16.0	5	57.0	76.0	16.6	5	36.6	65.0	13.8	4





BFR377310				BFR377510				BFR377610				BFR380110			
A	B	C	D	A	B	C	D	A	B	C	D	A	B	C	D
Ventilado	314.0	30.0	27.0	Ventilado	276.0	24.0	22.0	Ventilado	256.0	22.0	19.0	Ventilado	247.0	20.4	18.5
				Imagen no disponible				Imagen no disponible							
E	F	G	H	E	F	G	H	E	F	G	H	E	F	G	H
49.6	65.0	15.3	5	44.3	65.0	15.0	5	44.0	65.0	15.0	5	34.2	66.0	13.0	4





BFR380210				BFR380310				BFR380410				BFR381010			
A	B	C	D	A	B	C	D	A	B	C	D	A	B	C	D
Ventilado	266.0	20.5	18.6	Ventilado	283.0	26.0	24.0	Sólido	247.5	13.0	11.0	Ventilado	266.0	22.0	20.0
															
E	F	G	H	E	F	G	H	E	F	G	H	E	F	G	H
27.4	66.0	13.4	4	34.5	66.0	13.0	4	34.2	66.0	13.0	4	34.2	66.0	14.0	4





BFR390110				BFR390310				BFR390410				BFR390610			
A	B	C	D	A	B	C	D	A	B	C	D	A	B	C	D
Ventilado	257.0	20.0	18.0	Ventilado	257.5	22.0	20.2	Ventilado	284.0	22.0	20.2	Ventilado	240.0	20.0	18.2
								Imagen no disponible							
E	F	G	H	E	F	G	H	E	F	G	H	E	F	G	H
40.5	59.0	12.7	4	40.6	59.0	13.0	4	43.5	59.0	13.3	4	40.6	59.0	13.0	4







© Schaeffler Automotive Aftermarket México S. de R.L. de C.V. se reserva todos y cada uno de los derechos sobre las fotografías exclusivas de la marca aquí presentadas; se prohíbe la reproducción parcial y/o total, uso, modificación y distribución de cada una de estas fotografías

BFR390710				BFR410410				BFR410710				BFR420510			
A	B	C	D	A	B	C	D	A	B	C	D	A	B	C	D
Sol	257.4	12.0	10.2	Ventilado	300.0	25.0	23.0	Ventilado	320.0	25.0	23.0	Ventilado	308.0	25.0	22.0
															
E	F	G	H	E	F	G	H	E	F	G	H	E	F	G	H
40.5	59.0	13.0	4	48.7	63.6	14.2	5	48.7	63.5	13.8	5	42.0	70.0	14.0	5





BFR500110				BFR500310				BFR500510				BFR500710			
A	B	C	D	A	B	C	D	A	B	C	D	A	B	C	D
Ventilado	252.0	18.0	16.0	Ventilado	280.0	23.0	21.4	Ventilado	305.0	25.0	23.4	Ventilado	320.0	29.0	26.0
															
E	F	G	H	E	F	G	H	E	F	G	H	E	F	G	H
49.0	62.0	12.8	4	44.5	69.0	12.6	5	46.5	69.0	12.6	5	49.6	69.0	12.5	5





BFR500910				BFR501110				BFR501510				BFR501610			
A	B	C	D	A	B	C	D	A	B	C	D	A	B	C	D
Ventilado	154.5	22.0	19.4	Ventilado	154.5	22.0	19.4	Ventilado	280.0	26.0	24.4	Ventilado	300.0	28.0	26.4
															
E	F	G	H	E	F	G	H	E	F	G	H	E	F	G	H
44.0	62.0	12.4	4	44.0	62.0	12.4	4	47.2	69.0	12.6	5	47.4	69.0	12.5	5





BFR501710				BFR510110				BFR510210				BFR510310			
A	B	C	D	A	B	C	D	A	B	C	D	A	B	C	D
Ventilado	256.0	145.9Int. 153.0pistas	144.0	Ventilado	260.0	23.0	21.0	Ventilado	240.5	21.0	19.0	Ventilado	259.0	23.0	21.0
															
E	F	G	H	E	F	G	H	E	F	G	H	E	F	G	H
22.0	43.8	62.2	4	34.0	92.0	M10X1.25	4	45.0	61.0	12.7	4	47.0	64.0	12.4	4





A: Tipo
 B: Diámetro
 C: Espesor Nominal
 D: Espesor Mínimo
 E: Altura
 F: Diámetro Piloto
 G: Diámetro de Birlo o Barreno
 H: Número de Birlos o Barrenos



BFR510410				BFR510510				BFR510610				BFR510710			
A	B	C	D	A	B	C	D	A	B	C	D	A	B	C	D
Ventilado	281.5	23.0	21.0	Ventilado	300.0	25.0	23.0	Ventilado	282.0	23.0	21.0	Ventilado	300.0	28.1	26.4
															
E	F	G	H	E	F	G	H	E	F	G	H	E	F	G	H
47.4	64.0	12.8	5	46.5	64.0	12.5	5	47.5	64.3	12.5	5	47.4	64.0	13.0	5





BFR510810				BFR510910				BFR511010				BFR511110			
A	B	C	D	A	B	C	D	A	B	C	D	A	B	C	D
Ventilado	240.0	21.0	19.0	Ventilado	261.8	21.0	19.0	Ventilado	262.0	21.0	19.0	Ventilado	296.0	28.0	26.0
															
E	F	G	H	E	F	G	H	E	F	G	H	E	F	G	H
39.0	61.0	13.0	4	47.0	64.2	12.8	5	44.6	64.2	12.8	4	47.5	64.0	12.6	5



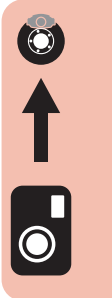

BFR511210				BFR511310				BFR511410				BFR511910			
A	B	C	D	A	B	C	D	A	B	C	D	A	B	C	D
Ventilado	296.0	28.0	26.0	Ventilado	320.0	28.0	26.0	Ventilado	330.0	28.0	26.0	Ventilado	300.0	25.0	23.0
															
E	F	G	H	E	F	G	H	E	F	G	H	E	F	G	H
47.5	70.2	15.5	5	47.4	70.1	14.5	5	47.3	70.0	14.5	5	47.0	64.0	12.8	5





BFR512010				BFR512310				BFR512410				BFR512510			
A	B	C	D	A	B	C	D	A	B	C	D	A	B	C	D
Ventilado	320.0	28.0	26.0	Ventilado	292.7	25.0	23.0	Ventilado	262.0	21.0	19.0	Ventilado	261.7	21.0	19.0
															
E	F	G	H	E	F	G	H	E	F	G	H	E	F	G	H
47.5	70.3	14.6	5	47.2	64.2	12.7	5	47.5	64.3	12.7	5	44.8	61.0	12.8	4





© Schaeffler Automotive Aftermarket México S. de R.L. de C.V. se reserva todos y cada uno de los derechos sobre las fotografías exclusivas de la marca aquí presentadas; se prohíbe la reproducción parcial y/o total, uso, modificación y distribución de cada una de estas fotografías



BFR512610				BFR512710				BFR512910				BFR520110			
A	B	C	D	A	B	C	D	A	B	C	D	A	B	C	D
Ventilado	320.0	28.0	26.0	Ventilado	261.7	21.0	19.0	Ventilado	277.0	26.0	24.0	Ventilado	277.0	26.0	24.0
															
E	F	G	H	E	F	G	H	E	F	G	H	E	F	G	H
47.0	70.2	14.7	5	45.0	61.0	12.5	4	52.3	74.0	12.7	5	52.3	74.0	12.7	5





BFR520310				BFR520410				BFR520510				BFR520610			
A	B	C	D	A	B	C	D	A	B	C	D	A	B	C	D
Sólido	240.0	12.0	11.0	Ventilado	260.0	26.0	24.0	Ventilado	278.8	30.0	28.0	Ventilado	250.0	22.0	20.0
															
E	F	G	H	E	F	G	H	E	F	G	H	E	F	G	H
35.0	76.0	8.1	4	37.1	81.0	10.6	6	46.5	100.0	M10X1.25	6	37.1	81.0	10.8	6





BFR520710				BFR520810				BFR521310				BFR521510			
A	B	C	D	A	B	C	D	A	B	C	D	A	B	C	D
Sólido	240.0	12.0	10.0	Ventilado	296.0	26.0	24.0	Ventilado	280.0	22.0	20.0	Ventilado	232.5	18.0	16.0
															
E	F	G	H	E	F	G	H	E	F	G	H	E	F	G	H
45.0	61.0	12.7	4	44.0	68.0	12.8	5	50.0	68.0	12.7	4	45.2	61.0	12.7	4





BFR521610				BFR521710				BFR522110				BFR522210			
A	B	C	D	A	B	C	D	A	B	C	D	A	B	C	D
Ventilado	246.0	18.0	16.0	Ventilado	283.0	28.0	26.0	Ventilado	296.0	24.1	22.0	Ventilado	240.0	18.0	16.0
															
E	F	G	H	E	F	G	H	E	F	G	H	E	F	G	H
45.3	61.0	12.7	4	38.3	100.0	8.7	6	49.5	68.0	12.6	5	45.5	61.0	12.7	4





A: Tipo
 B: Diámetro
 C: Espesor Nominal
 D: Espesor Mínimo
 E: Altura
 F: Diámetro Piloto
 G: Diámetro de Birlo o Barreno
 H: Número de Birlos o Barrenos



BFR522310				BFR522410				BFR523010				BFR523110			
A	B	C	D	A	B	C	D	A	B	C	D	A	B	C	D
Ventilado	300.0	28.0	26.0	Ventilado	320.0	28.0	26.0	Ventilado	260.0	25.9	24.1	Ventilado	256.7	22.2	20.0
															
E	F	G	H	E	F	G	H	E	F	G	H	E	F	G	H
38.2	100.0	M10X1.25	6	49.2	68.0	13.0	5	40.0	92.0	10.4	6	49.0	68.0	12.8	4





BFR523210				BFR523310				BFR523410				BFR523510			
A	B	C	D	A	B	C	D	A	B	C	D	A	B	C	D
Ventilado	276.7	26.0	24.0	Ventilado	320.0	26.2	24.5	Ventilado	280.0	28.3	26.0	Ventilado	319.5	28.0	26.0
															
E	F	G	H	E	F	G	H	E	F	G	H	E	F	G	H
39.2	100.0	M10X1.25	6	43.0	82.0	13.7	6	49.5	68.0	12.7	5	44.2	68.0	12.8	5





BFR523610				BFR523710				BFR523910				BFR524010			
A	B	C	D	A	B	C	D	A	B	C	D	A	B	C	D
Ventilado	296.0	26.4	24.0	Ventilado	260.0	22.0	20.0	Ventilado	283.0	28.0	26.0	Ventilado	295.8	28.0	26.0
															
E	F	G	H	E	F	G	H	E	F	G	H	E	F	G	H
49.0	68.0	13.0	5	44.0	68.0	12.7	4	38.3	68.0	12.8	6	38.2	68.0	12.8	6



BFR524110				BFR524410				BFR524710				BFR525110			
A	B	C	D	A	B	C	D	A	B	C	D	A	B	C	D
Ventilado	290.0	28.0	26.0	Ventilado	280.0	24.0	22.0	Ventilado	350.0	30.0	28.5	Ventilado	260.0	22.0	20.0
															
E	F	G	H	E	F	G	H	E	F	G	H	E	F	G	H
49.2	68.0	13.0	5	44.0	68.0	13.0	4	43.0	90.0	13.5	6	43.9	61.0	14.0	4







© Schaeffler Automotive Aftermarket México S. de R.L. de C.V. se reserva todos y cada uno de los derechos sobre las fotografías exclusivas de la marca aquí presentadas; se prohíbe la reproducción parcial y/o total, uso, modificación y distribución de cada una de estas fotografías

BFR525410				BFR525510				BFR525810				BFR526110			
A	B	C	D	A	B	C	D	A	B	C	D	A	B	C	D
Ventilado	296.0	26.0	24.0	Ventilado	319.0	28.0	26.0	Ventilado	279.6	24.0	22.0	Ventilado	258.0	22.0	20.0
															
E	F	G	H	E	F	G	H	E	F	G	H	E	F	G	H
44.2	68.0	13.0	5	50.0	68.0	12.5	5	44.0	68.0	12.8	5	44.0	61.0	0.0	4





BFR526310				BFR526410				BFR526510				BFR530110			
A	B	C	D	A	B	C	D	A	B	C	D	A	B	C	D
Ventilado	295.5	26.0	24.0	Ventilado	319.7	28.0	26.0	Ventilado	274.7	28.0	26.0	Ventilado	275.0	25.0	23.0
															
E	F	G	H	E	F	G	H	E	F	G	H	E	F	G	H
44.0	68.0	12.8	5	44.0	68.0	12.8	5	53.0	68.0	12.8	6	49.5	55.0	14.8	5





BFR530210				BFR530310				BFR530410				BFR530510			
A	B	C	D	A	B	C	D	A	B	C	D	A	B	C	D
Ventilado	275.0	28.0	26.0	Ventilado	295.9	28.1	26.4	Ventilado	319.0	28.0	26.0	Ventilado	338.0	28.2	26.0
															
E	F	G	H	E	F	G	H	E	F	G	H	E	F	G	H
49.3	62.0	14.4	5	49.0	62.0	14.6	5	67.5	108.0	14.5	6	68.0	108.0	14.5	6





BFR530610				BFR530710				BFR530810				BFR530910			
A	B	C	D	A	B	C	D	A	B	C	D	A	B	C	D
Sólido	233.0	18.0	16.0	Ventilado	312.0	32.0	30.0	Ventilado	275.0	25.0	23.0	Ventilado	235.0	18.0	16.0
															
E	F	G	H	E	F	G	H	E	F	G	H	E	F	G	H
30.0	91.0	M10X1.25	4	69.8	115.0	12.5	5	49.2	62.0	14.6	5	43.0	55.0	14.7	4





A: Tipo
 B: Diámetro
 C: Espesor Nominal
 D: Espesor Mínimo
 E: Altura
 F: Diámetro Piloto
 G: Diámetro de Birlo o Barreno
 H: Número de Birlos o Barrenos



BFR531010				BFR531110				BFR531210				BFR531310			
A	B	C	D	A	B	C	D	A	B	C	D	A	B	C	D
Ventilado	285.0	28.0	26.0	Ventilado	296.0	28.0	25.0	Ventilado				Ventilado	255.0	22.0	19.0
															
E	F	G	H	E	F	G	H	E	F	G	H	E	F	G	H
48.5	105.0	10.5	6	49.5	62.0	14.5	5					46.0	55.0	14.5	4





BFR531510				BFR531710				BFR531810				BFR531910			
A	B	C	D	A	B	C	D	A	B	C	D	A	B	C	D
Ventilado	275.0	25.0	22.0	Ventilado	352.6	32.2	29.0	Ventilado	275.0	28.0	26.0	Ventilado	275.0	22.0	19.0
															
E	F	G	H	E	F	G	H	E	F	G	H	E	F	G	H
46.5	62.0	14.5	5	83.3	112.0	16.5	5	58.7	62.0	14.5	5	46.5	55.0	14.6	5





BFR532210				BFR532310				BFR532710				BFR532810			
A	B	C	D	A	B	C	D	A	B	C	D	A	B	C	D
Ventilado	328.0	28.0	25.0	Ventilado	297.0	25.0	23.0	Ventilado	255.0	25.0	22.0	Ventilado	318.5	28.0	26.0
															
E	F	G	H	E	F	G	H	E	F	G	H	E	F	G	H
49.0	62.0	14.5	5	67.5	108.0	14.5	6	49.4	55.0	14.5	5	67.5	108.0	14.5	6





BFR532910				BFR538350				BFR540310				BFR540410			
A	B	C	D	A	B	C	D	A	B	C	D	A	B	C	D
Ventilado	296.0	38.0	35.0	Ventilado	254.6	19.8	18.7	Ventilado	276.1	26.0	24.4	Ventilado	290.0	26.0	24.0
															
E	F	G	H	E	F	G	H	E	F	G	H	E	F	G	H
61.0	77.0	16.5	6	43.1	55.0	14.8	4	45.5	69.0	12.6	5	46.0	94.0	12.5	6







© Schaeffler Automotive Aftermarket México S. de R.L. de C.V. se reserva todos y cada uno de los derechos sobre las fotografías exclusivas de la marca aquí presentadas; se prohíbe la reproducción parcial y/o total, uso, modificación y distribución de cada una de estas fotografías

BFR540510				BFR540610				BFR540810				BFR540910			
A	B	C	D	A	B	C	D	A	B	C	D	A	B	C	D
Ventilado	315.0	24.0	22.4	Ventilado	290.0	26.0	24.4	Ventilado	294.0	24.0	22.4	Ventilado	294.0	28.0	26.4
															
E	F	G	H	E	F	G	H	E	F	G	H	E	F	G	H
45.5	87.0	10.5	6	46.0	69.0	13.0	5	45.9	69.0	12.6	5	46.5	93.9	12.5	6





BFR541010				BFR541210				BFR541410				BFR560110			
A	B	C	D	A	B	C	D	A	B	C	D	A	B	C	D
Ventilado	256.0	24.0	22.4	Ventilado	320.0	28.0	26.0	Ventilado	229.0	17.0	15.4	Ventilado	246.0	20.0	18.0
															
E	F	G	H	E	F	G	H	E	F	G	H	E	F	G	H
45.0	69.0	13.0	4	45.9	94.0	12.6	6	41.7	64.0	12.6	4	50.0	60.0	12.7	4





BFR560210				BFR560310				BFR560410				BFR580110			
A	B	C	D	A	B	C	D	A	B	C	D	A	B	C	D
Ventilado	280.0	22.0	20.0	Ventilado	252.0	20.0	18.0	Ventilado	294.6	25.0	23.0	Ventilado	296.0	28.0	26.0
															
E	F	G	H	E	F	G	H	E	F	G	H	E	F	G	H
47.0	62.0	12.6	5	40.0	60.0	12.5	4	49.2	62.0	12.7	5	48.5	72.0	13.0	5





BFR580210				BFR580410				BFR580510				BFR580710			
A	B	C	D	A	B	C	D	A	B	C	D	A	B	C	D
Ventilado	320.0	28.0	26.0	Ventilado	278.0	25.0	23.0	Ventilado	300.0	24.9	23.0	Ventilado	257.7	23.0	21.0
															
E	F	G	H	E	F	G	H	E	F	G	H	E	F	G	H
48.4	72.0	13.0	5	48.6	72.0	14.0	5	48.4	72.0	14.0	5	44.0	55.0	12.8	4

A: Tipo
 B: Diámetro
 C: Espesor Nominal
 D: Espesor Mínimo
 E: Altura
 F: Diámetro Piloto
 G: Diámetro de Birlo o Barreno
 H: Número de Birlos o Barrenos



BFR580810				BFR580910				BFR581010				BFR581210			
A	B	C	D	A	B	C	D	A	B	C	D	A	B	C	D
Ventilado	296.8	28.0	26.0	Ventilado	295.0	25.0	23.0	Ventilado	296.7	28.0	26.0	Ventilado	280.0	25.0	23.0
															
E	F	G	H	E	F	G	H	E	F	G	H	E	F	G	H
51.3	68.0	13.3	5	51.6	68.0	13.3	5	51.6	68.0	13.4	5	51.6	68.0	13.4	5





BFR590110				BFR626050				BRR110410				BRR110610			
A	B	C	D	A	B	C	D	A	B	C	D	A	B	C	D
Ventilado	293.3.8	40.0	37.0	Ventilado	296.0	28.0	26.0	Ventilado	352.5	22.0	20.4	Sólido	270.0	9.3	7.2
															
E	F	G	H	E	F	G	H	E	F	G	H	E	F	G	H
57.4	110.0	12.5	12	53.1	68.0	12.8	6	72.0	78.5	17.3	5	53.6	57.4	14.0	5





BRR110710				BRR110810				BRR110910				BRR111110			
A	B	C	D	A	B	C	D	A	B	C	D	A	B	C	D
Sólido	285.0	12.2	11.0	Sólido	285.0	11.2	9.5	Sólido	290.0	12.5	11.2	Ventilado	320.0	22.0	20.5
															
E	F	G	H	E	F	G	H	E	F	G	H	E	F	G	H
59.5	72.0	16.7	5	59.5	71.9	15.5	5	57.0	72.0	14.0	5	67.0	72.5	16.7	5





BRR111210				BRR111510				BRR111810				BRR112010			
A	B	C	D	A	B	C	D	A	B	C	D	A	B	C	D
Sólido	305.0	10.0	8.5	Sólido	320.0	10.0	8.5	Ventilado	352.5	30.0	28.5	Sólido	320.0	14.1	12.5
															
E	F	G	H	E	F	G	H	E	F	G	H	E	F	G	H
75.4	72.2	15.2	5	67.0	72.5	16.8	5	131.0	123.0	17.0	8	66.0	71.9	16.2	5





© Schaeffler Automotive Aftermarket México S. de R.L. de C.V. se reserva todos y cada uno de los derechos sobre las fotografías exclusivas de la marca aquí presentadas; se prohíbe la reproducción parcial y/o total, uso, modificación y distribución de cada una de estas fotografías

BRR112210				BRR112310				BRR112410				BRR112810			
A	B	C	D	A	B	C	D	A	B	C	D	A	B	C	D
Sólido	262.0	10.0	8.4	Sólido	316.0	12.0	10.4	Sólido	302.0	10.0	8.4	Sólido	330.0	14.0	12.5
															
E	F	G	H	E	F	G	H	E	F	G	H	E	F	G	H
60.2	80.0	12.7	5	76.7	72.2	16.8	5	60.0	80.0	12.8	5	63.5	72.0	17.0	5

BRR112910				BRR113010				BRR113110				BRR113210			
A	B	C	D	A	B	C	D	A	B	C	D	A	B	C	D
Sólido	305.0	12.0	10.4	Sólido	316.0	12.0	10.4	Ventilado	357.5	34.0	32.4	Ventilado	330.0	22.0	20.5
															
E	F	G	H	E	F	G	H	E	F	G	H	E	F	G	H
33.8	72.7	14.3	5	77.0	72.1	16.6	5	125.0	123.0	17.0	8	63.5	72.0	17.0	5





BRR113410				BRR113510				BRR113810				BRR114010			
A	B	C	D	A	B	C	D	A	B	C	D	A	B	C	D
Sólido	328.0	12.0	10.0	Sólido	362.0	10.0	8.4	Sólido	278.0	12.0	10.4	Sólido	279.3	16.0	14.2
															
E	F	G	H	E	F	G	H	E	F	G	H	E	F	G	H
36.0	72.5	14.6	5	44.0	62.5	12.5	4	33.2	70.0	11.1	5	82.0	79.0	18.0	5



BRR114110				BRR114310				BRR120510				BRR120910			
A	B	C	D	A	B	C	D	A	B	C	D	A	B	C	D
Ventilado	300.0	22.0	20.0	Sólido	278.0	12.0	10.0	Ventilado	267.0	14.0	12.8	Sólido	284.0	12.2	10.4
				Imagen no disponible											
E	F	G	H	E	F	G	H	E	F	G	H	E	F	G	H
80.2	79.0	17.6	5	43.3	70.0	16.7	5	50.0	70.6	14.4	5	61.7	64.5	15.9	5

A: Tipo
 B: Diámetro
 C: Espesor Nominal
 D: Espesor Mínimo
 E: Altura
 F: Diámetro Piloto
 G: Diámetro de Birlo o Barreno
 H: Número de Birlos o Barrenos



BRR121010				BRR121110				BRR121210				BRR121410			
A	B	C	D	A	B	C	D	A	B	C	D	A	B	C	D
Sólido	285.0	12.3	11.0	Sólido	334.2	14.0	12.0	Ventilado	395.0	38.0	36.0	Sólido	250.0	9.0	8.0
															
E	F	G	H	E	F	G	H	E	F	G	H	E	F	G	H
58.4	71.0	14.4	5	57.3	87.4	14.2	5	124.0	139.3	12.8	10	35.0	55.0	12.9	4





BRR121510				BRR121710				BRR121810				BRR122010			
A	B	C	D	A	B	C	D	A	B	C	D	A	B	C	D
Sólido	280.0	12.0	10.0	Ventilado	326.0	30.0	28.0	Ventilado	326.0	30.0	28.0	Ventilado	343.0	22.0	19.0
															
E	F	G	H	E	F	G	H	E	F	G	H	E	F	G	H
34.2	63.5	13.5	5	98.0	127.0	16.5	8	98.5	127.0	16.0	8	52.2	90.0	16.0	6



BRR122210				BRR122310				BRR122510				BRR123010			
A	B	C	D	A	B	C	D	A	B	C	D	A	B	C	D
Ventilado	348.0	20.0	18.5	Ventilado	316.0	20.3	18.4	Sólido	301.0	12.0	11.0	Sólido	334.0	14.0	12.0
															
E	F	G	H	E	F	G	H	E	F	G	H	E	F	G	H
86.2	90.0	15.2	6	38.7	64.5	14.7	5	58.7	82.0	14.3	5	57.3	87.5	16.0	5





BRR123110				BRR123210				BRR123410				BRR123510			
A	B	C	D	A	B	C	D	A	B	C	D	A	B	C	D
Sólido	279.5	10.0	8.0	Sólido	330.0	11.0	10.0	Ventilado	301.7	18.0	16.0	Ventilado	342.0	22.0	20.0
															
E	F	G	H	E	F	G	H	E	F	G	H	E	F	G	H
40.0	72.0	13.0	5	38.0	68.0	14.5	5	56.5	72.0	16.0	5	56.0	90.0	16.6	6







© Schaeffler Automotive Aftermarket México S. de R.L. de C.V. se reserva todos y cada uno de los derechos sobre las fotografías exclusivas de la marca aquí presentadas; se prohíbe la reproducción parcial y/o total, uso, modificación y distribución de cada una de estas fotografías

BRR124110				BRR124310				BRR124410				BRR124710			
A	B	C	D	A	B	C	D	A	B	C	D	A	B	C	D
Ventilado	300.0	19.0	17.4	Ventilado	330.0	22.0	20.3	Sólido	280.0	16.0	13.0	Ventilado	390.0	39.0	37.4
															
E	F	G	H	E	F	G	H	E	F	G	H	E	F	G	H
35.0	70.8	14.7	5	75.5	87.6	15.2	5	16.3	107.5	10.9	10	124.0	139.5	13.0	10





BRR124810				BRR125110				BRR125210				BRR125310			
A	B	C	D	A	B	C	D	A	B	C	D	A	B	C	D
Ventilado	345.0	36.0	34.4	Sólido	271.0	11.0	9.0	Ventilado	348.0	25.0	23.0	Ventilado	340.0	34.0	32.4
															
E	F	G	H	E	F	G	H	E	F	G	H	E	F	G	H
90.5	127.0	16.0	8	41.0	63.5	13.8	5	80.0	90.0	15.7	6	125.0	128.0	13.2	8





BRR125410				BRR125610				BRR125710				BRR125810			
A	B	C	D	A	B	C	D	A	B	C	D	A	B	C	D
Sólido	302.6	11.0	9.0	Sólido	280.0	11.0	9.0	Sólido	316.0	11.0	9.5	Sólido	280.0	16.0	14.0
															
E	F	G	H	E	F	G	H	E	F	G	H	E	F	G	H
51.0	63.5	15.9	5	50.7	63.5	13.7	5	51.0	64.0	13.8	5	69.0	96.0	M10X1.5	5





BRR126210				BRR126410				BRR130310				BRR131010			
A	B	C	D	A	B	C	D	A	B	C	D	A	B	C	D
Ventilado	336.0	22.0	20.0	Ventilado	363.0	38.0	36.0	Ventilado	390.3	39.5	36.0	Ventilado	345.0	36.2	34.7
															
E	F	G	H	E	F	G	H	E	F	G	H	E	F	G	H
45.0	90.0	15.6	6	126.0	128.0	13.3	8	87.0	152.3	14.9	10	111.0	139.3	16.7	10

A: Tipo
 B: Diámetro
 C: Espesor Nominal
 D: Espesor Mínimo
 E: Altura
 F: Diámetro Piloto
 G: Diámetro de Birlo o Barreno
 H: Número de Birlos o Barrenos



BRR131210				BRR131410				BRR131510				BRR131610			
A	B	C	D	A	B	C	D	A	B	C	D	A	B	C	D
Ventilado	295.0	20.0	18.5	Sólido	264.0	9.8	8.0	Sólido	240.0	10.0	8.0	Ventilado	325.1	20.0	18.5
															
E	F	G	H	E	F	G	H	E	F	G	H	E	F	G	H
73.0	70.8	13.3	5	42.0	65.5	14.0	5	42.0	57.0	14.0	4	85.0	78.6	16.5	6



BRR131710				BRR131810				BRR132510				BRR132610			
A	B	C	D	A	B	C	D	A	B	C	D	A	B	C	D
Ventilado	330.2	30.2	28.5	Ventilado	325.5	20.0	18.5	Ventilado	330.0	29.0	27.0	Sólido	270.0	14.0	12.0
															
E	F	G	H	E	F	G	H	E	F	G	H	E	F	G	H
96.0	78.5	16.6	6	84.0	78.5	13.0	6	92.9	122.7	16.5	8	45.3	65.7	14.3	5



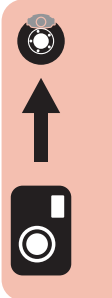

BRR132810				BRR133110				BRR133410				BRR133610			
A	B	C	D	A	B	C	D	A	B	C	D	A	B	C	D
Ventilado	325.0	30.0	28.5	Sólido	300.0	12.0	10.5	Ventilado	345.0	20.0	18.5	Sólido	257.0	11.0	8.0
															
E	F	G	H	E	F	G	H	E	F	G	H	E	F	G	H
131.5	122.8	16.4	8	35.0	70.7	14.2	6	85.4	78.5	16.5	6	56.7	60.0	12.8	4





BRR133710				BRR134110				BRR134410				BRR134610			
A	B	C	D	A	B	C	D	A	B	C	D	A	B	C	D
Ventilado	303.0	20.0	18.4	Sólido	292.0	12.0	10.5	Ventilado	331.0	20.0	18.4	Sólido	268.0	12.0	10.0
															
E	F	G	H	E	F	G	H	E	F	G	H	E	F	G	H
71.8	70.7	12.7	5	48.0	67.6	16.0	5	53.0	75.5	16.0	6	45.0	60.0	14.0	5





© Schaeffler Automotive Aftermarket México S. de R.L. de C.V. se reserva todos y cada uno de los derechos sobre las fotografías exclusivas de la marca aquí presentadas; se prohíbe la reproducción parcial y/o total, uso, modificación y distribución de cada una de estas fotografías



BRR134710				BRR135210				BRR135410				BRR136110			
A	B	C	D	A	B	C	D	A	B	C	D	A	B	C	D
Ventilado	315.0	23.0	21.5	Ventilado	355.4	40.0	38.0	Ventilado	303.0	20.0	18.4	Sólido	288.0	12.0	10.0
												Imagen no disponible			
E	F	G	H	E	F	G	H	E	F	G	H	E	F	G	H
48.0	67.6	16.2	5	150.0	130.0	16.5	8	71.7	67.4	16.2	5	46.0	70.7	13.8	5





BRR136310				BRR137110				BRR320210				BRR320310			
A	B	C	D	A	B	C	D	A	B	C	D	A	B	C	D
Ventilado	324.0	18.0	16.0	Ventilado	345.0	20.0	18.0	Sólido	259.0	10.0	8.4	Sólido	259.0	10.0	8.4
															
E	F	G	H	E	F	G	H	E	F	G	H	E	F	G	H
80.0	71.0	15.8	6	52.9	78.6	16.0	6	44.0	64.2	15.0	4	44.2	64.1	16.2	4





BRR320610				BRR322710				BRR340110				BRR340210			
A	B	C	D	A	B	C	D	A	B	C	D	A	B	C	D
Ventilado	294.0	19.0	17.4	Ventilado	300.0	20.0	18.4	Sólido	272.0	16.0	14.0	Ventilado	285.0	22.0	19.0
															
E	F	G	H	E	F	G	H	E	F	G	H	E	F	G	H
59.5	75.0	14.6	5	66.0	75.0	14.5	5	96.8	85.0	15.0	5	93.2	120.0	15.0	6





BRR342910				BRR343010				BRR350110				BRR350210			
A	B	C	D	A	B	C	D	A	B	C	D	A	B	C	D
Ventilado	303.0	28.0	25.0	Sólido	297.5	16.0	14.0	Sólido	238.0	8.0	7.0	Sólido	240.0	8.0	7.0
															
E	F	G	H	E	F	G	H	E	F	G	H	E	F	G	H
93.4	120.0	15.5	6	71.2	85.0	15.4	6	74.0	52.2	M12X1.5	4	81.0	55.0	M12X1.5	4



A: Tipo
 B: Diámetro
 C: Espesor Nominal
 D: Espesor Mínimo
 E: Altura
 F: Diámetro Piloto
 G: Diámetro de Birlo o Barreno
 H: Número de Birlos o Barrenos



BRR350410				BRR370110				BRR370210				BRR370310			
A	B	C	D	A	B	C	D	A	B	C	D	A	B	C	D
Sólido	260.0	8.0	7.0	Sólido	226.0	10.2	8.0	Sólido	226.0	10.0	8.0	Sólido	244.7	10.0	8.0
															
E	F	G	H	E	F	G	H	E	F	G	H	E	F	G	H
86.2	54.9	0.0	5	71.2		M12X1.5	4	72.0		M14x1.5	4	64.0	68.0	15.2	5





BRR370410				BRR370510				BRR370610				BRR370910			
A	B	C	D	A	B	C	D	A	B	C	D	A	B	C	D
Ventilado	294.0	22.0	19.5	Sólido	232.0	9.0	7.0	Sólido	280.0	12.0	10.0	Sólido	286.0	12.0	10.0
															
E	F	G	H	E	F	G	H	E	F	G	H	E	F	G	H
44.3	76.0	16.5	5	39.4	65.0	15.5	5	40.3	68.0	16.0	5	48.2	65.0	15.3	5



BRR371510				BRR372010				BRR373210				BRR374710			
A	B	C	D	A	B	C	D	A	B	C	D	A	B	C	D
Sólido	300.0	12.0	10.0	Sólido	260.0	12.0	10.0	Ventilado	330.0	28.0	26.0	Sólido	272.0	10.0	8.0
															
E	F	G	H	E	F	G	H	E	F	G	H	E	F	G	H
36.0	68.0	15.3	5	48.2	65.0	15.0	5	73.6	85.0	15.2	5	48.0	65.0	15.3	5



BRR375010				BRR375410				BRR375610				BRR375810			
A	B	C	D	A	B	C	D	A	B	C	D	A	B	C	D
Sólido	253.0	10.0	8.0	Sólido	300.0	12.0	10.0	Sólido	300.0	22.0	19.0	Sólido	230.0	9.0	7.0
				Imagen no disponible								Imagen no disponible			
E	F	G	H	E	F	G	H	E	F	G	H	E	F	G	H
51.0	65.0	15.2	5	48.4	65.2	15.4	5	51.0	76.0	16.5	5	41.0	65.0	13.0	4







© Schaeffler Automotive Aftermarket México S. de R.L. de C.V. se reserva todos y cada uno de los derechos sobre las fotografías exclusivas de la marca aquí presentadas; se prohíbe la reproducción parcial y/o total, uso, modificación y distribución de cada una de estas fotografías

BRR380310				BRR389510				BRR389710				BRR389810			
A	B	C	D	A	B	C	D	A	B	C	D	A	B	C	D
Sólido	268.0	12.0	10.0	Sólido	249.2	9.3	7.0	Sólido	247.0	8.0	6.0	Sólido	247.0	9.0	8.0
															
E	F	G	H	E	F	G	H	E	F	G	H	E	F	G	H
73.5		M12X1.25	4	69.3		M12X1.25	4	25.0	71.0	13.0	4	35.5	71.1	13.0	4

BRR390210				BRR410410				BRR500310				BRR501010			
A	B	C	D	A	B	C	D	A	B	C	D	A	B	C	D
Sólido	240.0	11.0	9.2	Sólido	280.0	11.0	9.0	Sólido	262.0	10.0	8.5	Sólido	302.0	11.0	9.4
															
E	F	G	H	E	F	G	H	E	F	G	H	E	F	G	H
40.0	59.0	13.0	4	40.9	63.5	14.0	5	45.0	76.0	12.5	5	71.5	69.0	12.5	5





BRR501410				BRR510310				BRR510410				BRR510510			
A	B	C	D	A	B	C	D	A	B	C	D	A	B	C	D
Sólido	302.0	10.0	8.4	Sólido	260.0	9.0	8.0	Sólido	260.0	9.0	8.0	Sólido	282.0	9.2	7.5
															
E	F	G	H	E	F	G	H	E	F	G	H	E	F	G	H
54.5	76.0	13.0	5	48.5	64.0	12.8	5	48.4	64.0	12.6	4	59.0	64.0	12.6	5





BRR510610				BRR510810				BRR510910				BRR511010			
A	B	C	D	A	B	C	D	A	B	C	D	A	B	C	D
Sólido	313.0	11.3	9.5	Sólido	259.7	9.3	8.0	Sólido	333.5	11.0	9.0	Sólido	259.6	9.0	8.0
															
E	F	G	H	E	F	G	H	E	F	G	H	E	F	G	H
56.7	64.0	12.7	5	48.7	64.3	12.8	5	64.0	70.3	14.8	5	42.0	64.1	12.6	5





A: Tipo
 B: Diámetro
 C: Espesor Nominal
 D: Tipo
 E: Altura
 F: Diámetro Piloto
 G: Diámetro de Birlo o Barreno
 H: Número de Birlos o Barrenos

BRR511110				BRR511210				BRR511310				BRR511610			
A	B	C	D	A	B	C	D	A	B	C	D	A	B	C	D
Sólido	305.0	9.0	7.5	Sólido	312.3	11.0	9.0	Sólido	333.8	11.0	9.0	Sólido	238.8	9.0	7.0
															
E	F	G	H	E	F	G	H	E	F	G	H	E	F	G	H
61.0	64.0	12.6	5	63.4	70.0	14.6	5	55.8	70.0	15.0	5	33.4	61.0	12.9	4





BRR511710				BRR512510				BRR512810				BRR520410			
A	B	C	D	A	B	C	D	A	B	C	D	A	B	C	D
Sólido	282.0	9.0	8.0	Sólido	257.7	9.1	8.0	Ventilado	307.7	16.0	14.0	Sólido	234.0	7.2	6.0
															
E	F	G	H	E	F	G	H	E	F	G	H	E	F	G	H
49.0	64.0	12.6	5	44.5	68.0	12.6	4	62.2	68.0	13.0	5	40.3	68.0	13.0	4



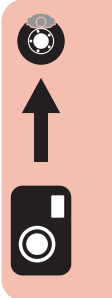

BRR520810				BRR521110				BRR521210				BRR521310			
A	B	C	D	A	B	C	D	A	B	C	D	A	B	C	D
Sólido	257.7	10.0	9.0	Sólido	291.5	9.0	8.0	Sólido	319.5	14.2	12.0	Ventilado	307.6	16.0	14.0
															
E	F	G	H	E	F	G	H	E	F	G	H	E	F	G	H
45.0	68.0	12.7	4	63.0	68.0	12.5	5	57.9	82.0	14.0	6	62.0	68.0	13.0	5



BRR521610				BRR521810				BRR521910				BRR522010			
A	B	C	D	A	B	C	D	A	B	C	D	A	B	C	D
Ventilado	291.2	16.0	14.0	Ventilado	307.7	16.0	14.0	Ventilado	285.5	18.0	16.0	Ventilado	308.0	18.0	16.0
															
E	F	G	H	E	F	G	H	E	F	G	H	E	F	G	H
62.0	68.0	12.8	5	62.2	68.0	13.0	5	61.5	68.0	13.0	6	62.8	68.0	13.0	6





© Schaeffler Automotive Aftermarket México S. de R.L. de C.V. se reserva todos y cada uno de los derechos sobre las fotografías exclusivas de la marca aquí presentadas; se prohíbe la reproducción parcial y/o total, uso, modificación y distribución de cada una de estas fotografías



BRR530110				BRR530210				BRR530310				BRR530410			
A	B	C	D	A	B	C	D	A	B	C	D	A	B	C	D
Ventilado	312.0	18.2	16.0	Sólido	269.0	12.0	10.5	Ventilado	328.0	18.0	16.0	Sólido	303.0	9.2	8.0
															
E	F	G	H	E	F	G	H	E	F	G	H	E	F	G	H
68.1	106.1	14.5	6	64.8	62.0	14.5	5	103.0	110.0	16.5	5	62.7	62.0	14.5	5



BRR530510				BRR530610				BRR530810				BRR530910			
A	B	C	D	A	B	C	D	A	B	C	D	A	B	C	D
Sólido	291.0	12.0	10.5	Sólido	281.0	10.0	8.5	Sólido	281.0	10.0	8.5	Sólido	309.0	10.0	8.5
															
E	F	G	H	E	F	G	H	E	F	G	H	E	F	G	H
68.5	62.0	14.5	5	66.8	62.0	14.5	5	67.0	62.0	14.5	5	69.5	62.0	14.8	5





BRR531010				BRR531110				BRR531210				BRR531310			
A	B	C	D	A	B	C	D	A	B	C	D	A	B	C	D
Sólido	281.0	12.0	10.5	Ventilado	345.0	18.0	16.0	Sólido	270.0	10.0	8.0	Sólido	259.0	9.0	7.5
															
E	F	G	H	E	F	G	H	E	F	G	H	E	F	G	H
55.0	62.0	14.5	5	76.0	112.0	16.3	5	37.0	55.0	14.6	5	30.6	55.0	14.5	5



BRR531410				BRR531510				BRR540310				BRR540410			
A	B	C	D	A	B	C	D	A	B	C	D	A	B	C	D
Sólido	279.0	10.0	8.5	Sólido	309.0	10.0	8.5	Ventilado	300.0	22.2	20.4	Sólido	262.0	10.0	8.4
															
E	F	G	H	E	F	G	H	E	F	G	H	E	F	G	H
30.5	62.0	14.6	5	62.5	62.0	14.5	5	72.5	93.7	12.5	6	60.2	69.0	12.5	5

A: Tipo
 B: Diámetro
 C: Espesor Nominal
 D: Tipo
 E: Altura
 F: Diámetro Piloto
 G: Diámetro de Birlo o Barreno
 H: Número de Birlos o Barrenos

BRR540510				BRR540810				BRR541010				BRR560110			
A	B	C	D	A	B	C	D	A	B	C	D	A	B	C	D
Sólido	302.0	10.1	8.4	Sólido	302.0	10.0	8.4	Sólido	301.7	10.0	8.4	Sólido	278.0	9.0	8.0
															
E	F	G	H	E	F	G	H	E	F	G	H	E	F	G	H
58.8	69.0	12.6	5	58.7	80.0	12.6	5	36.0	69.0	12.7	5	43.4	62.0	12.9	5

BRR560310				BRR560410				BRR560610				BRR580110			
A	B	C	D	A	B	C	D	A	B	C	D	A	B	C	D
Ventilado	308.0	16.0	14.0	Sólido	258.0	9.0	8.0	Sólido	259.0	9.0	8.0	Ventilado	325.0	18.0	16.0
								Imagen no disponible							
E	F	G	H	E	F	G	H	E	F	G	H	E	F	G	H
57.0	62.0	12.6	5	43.5	62.0	12.7	4	43.2	62.0	14.2	5	56.5	72.0	13.0	5

BRR580210				BRR580310				BRR580410				BRR580510			
A	B	C	D	A	B	C	D	A	B	C	D	A	B	C	D
Sólido	303.0	10.0	8.0	Ventilado	302.0	18.0	16.0	Sólido	302.0	11.0	9.0	Sólido	280.0	11.0	9.0
															
E	F	G	H	E	F	G	H	E	F	G	H	E	F	G	H
39.5	68.0	13.3	5	57.0	72.0	13.0	5	40.5	72.0	14.0	5	40.8	71.7	14.0	5

BRR580610				BRR580810				BRR580910			
A	B	C	D	A	B	C	D	A	B	C	D
Sólido	265.0	11.0	9.0	Sólido	265.0	9.0	7.0	Sólido	281.0	9.5	7.5
											
E	F	G	H	E	F	G	H	E	F	G	H
41.0	71.8	14.0	5	39.0	68.0	13.0	5	35.6	68.0	13.3	5



BFD370110					BRD110110					BRD110310					BRD110410				
A	B	C	D		A	B	C	D		A	B	C	D		A	B	C	D	
Tambor	230,0	231,0	240,0		Tambor	295,0	297,0	343,0		Tambor	180,0	182,0	221,5		Tambor	260,0	262,0	297,0	
E	F	G	H	I	E	F	G	H	I	E	F	G	H	I	E	F	G	H	I
46,5	90,0		M14X1,5	4	60,7	84,4	96,3	12,7	6	37,0	60,0	62,5	12,4	4	64,5	85,0	75,0	14,5	5



BRD110810					BRD110910					BRD111010					BRD111110				
A	B	C	D		A	B	C	D		A	B	C	D		A	B	C	D	
Tambor	294,8	297,5	342,0		Tambor	200,0	201,1	231,9		Tambor	220,0	221,3	250,2		Tambor	203,0	205,2	243,0	
E	F	G	H	I	E	F	G	H	I	E	F	G	H	I	E	F	G	H	I
73,5	112,0	78,9	17,2	5	41,1	61,2	57,4	14,2	5	45,5	68,0	57,4	14,2	5	40,5	57,7	62,5	12,5	4

BRD111310					BRD111520					BRD111810					BRD111910				
A	B	C	D		A	B	C	D		A	B	C	D		A	B	C	D	
Tambor	203,2	205,2	252,0		Tambor	203,0	205,0	239,7		Tambor	279,4	281,0	345,7		Tambor	228,6	229,6	280,0	
E	F	G	H	I	E	F	G	H	I	E	F	G	H	I	E	F	G	H	I
36,8	53,7	62,5	12,5	4	40,0	79,0			4	75,0	113,8	90,5	16,5	5	73,0	108,0	71,8	14,4	5



BRD112010					BRD112510					BRD112610					BRD112710				
A	B	C	D		A	B	C	D		A	B	C	D		A	B	C	D	
Tambor	228,6	230,0	273,2		Tambor	203,5	205,0	249,0		Tambor	180,0	182,0	219,3		Tambor	249,6	251,2	307,6	
E	F	G	H	I	E	F	G	H	I	E	F	G	H	I	E	F	G	H	I
75,4	90,0	72,0	15,7	5	46,0	61,0	59,0	14,0	4	40,0	58,0	62,5	12,5	4	65,5	77,6	69,8	14,3	5





A: Tipo
 B: Diámetro Nominal
 C: Diámetro Máximo
 D: Diámetro Exterior
 E: Ancho Pista
 F: Altura
 G: Diámetro de Piloto
 H: Diámetro del Birlo o Barreno
 I: Número de Birlos o Barrenos



BRD113510					BRD113910					BRD120110					BRD120410				
A	B	C	D		A	B	C	D		A	B	C	D		A	B	C	D	
Tambor	202,7	205,2	249,0		Tambor	228,5	230,6	267,5		Tambor	254,2	256,3	297,0		Tambor	200,0	201,5	244,0	
																			
E	F	G	H	I	E	F	G	H	I	E	F	G	H	I	E	F	G	H	I
44,0	64,0	62,2	12,3	4	46,2	60,0	80,0	12,7	5	61,5	72,0	72,0	13,8	5	39,0	57,5	63,5	13,9	4

BRD120510					BRD121510					BRD122210					BRD122710				
A	B	C	D		A	B	C	D		A	B	C	D		A	B	C	D	
Tambor	228.2	230.2	270.9		Tambor	279,0	281,5	322,5		Tambor	295.0	296.5	347.0		Tambor	254.0	256.3	299.0	
																			
E	F	G	H	I	E	F	G	H	I	E	F	G	H	I	E	F	G	H	I
51.0	66.0	63.5	13.8	5	74,5	93,5	71,0	15,2	5	67.0	80.0	93.0	14.0	6	72.3	87.8	71.0	14.2	5

BRD122810					BRD123210					BRD123310					BRD123510				
A	B	C	D		A	B	C	D		A	B	C	D		A	B	C	D	
Tambor	280.0	281.7	324.0		Tambor	203.0	204.3	239.0		Tambor	228.5	230.2	273.0		Tambor	228.7	230.1	268.0	
																			
E	F	G	H	I	E	F	G	H	I	E	F	G	H	I	E	F	G	H	I
71.6	94.0	87.3	14.6	5	44.8	81.2		11.8	4	50.0	70.2	63.5	14	4	51.5	66.5	63.5	14.5	4

BRD123610					BRD123910					BRD124210					BRD130310				
A	B	C	D		A	B	C	D		A	B	C	D		A	B	C	D	
Tambor	180.0	181.0	215.8		Tambor	280.2	282.1	326.0		Tambor	228.0	230.2	274.3		Tambor	200.0	201.4	232.0	
																			
E	F	G	H	I	E	F	G	H	I	E	F	G	H	I	E	F	G	H	I
40.0	76.5		11.8	4	68.5	93.9	87.3	14.9	5	50.0	67.0	72.2	14.0	5	52.5	66.0	57.5	14.2	5

© Schaeffler Automotive Aftermarket México S. de R.L. de C.V. se reserva todos y cada uno de los derechos sobre las fotografías exclusivas de la marca aquí presentadas; se prohíbe la reproducción parcial y/o total, uso, modificación y distribución de cada una de estas fotografías



BRD130610					BRD130810					BRD131210					BRD131410				
A	B	C	D		A	B	C	D		A	B	C	D		A	B	C	D	
Tambor	224.8	226.8	279.0		Tambor	200.0	201.0	228.0		Tambor	230.4	231.0	265.0		Tambor	254.0	256.2	298.0	
E	F	G	H	I	E	F	G	H	I	E	F	G	H	I	E	F	G	H	I
52.0	72.6	70.6	14.1	5	32.8	85.8		M12X1.5	4	49.8	69.3	57.0	15.0	4	73.2	93.8	78.4	14.7	5

BRD131510					BRD131610					BRD131910					BRD132310				
A	B	C	D		A	B	C	D		A	B	C	D		A	B	C	D	
Tambor	230.0	231.0	270.8		Tambor	241.8	243.5	303.7		Tambor	283.2	284.7	336.5		Tambor	199.5	201.0	240.0	
E	F	G	H	I	E	F	G	H	I	E	F	G	H	I	E	F	G	H	I
54.0	73.5	65.5	14.3	5	61.6	86.0	70.7	13.5	5	81.5	103.3	78.5	14.8	5	52.0	67.5	57.0	15.0	4



BRD132410					BRD132510					BRD133210					BRD133410				
A	B	C	D		A	B	C	D		A	B	C	D		A	B	C	D	
Tambor	253.7	255.5	294.6		Tambor	200.0	201.0	228.0		Tambor	295.0	296.5	335.0		Tambor	180.0	182.0	205.6	
E	F	G	H	I	E	F	G	H	I	E	F	G	H	I	E	F	G	H	I
59.0	71.1	96.5	12.3	6	32.8	83.5		M12X1.5	4	75.0	97.4	78.6	16.3	6	39.5	79.5(97.0)		M12X1.25	4





BRD133610					BRD133710					BRD134010					BRD134110				
A	B	C	D		A	B	C	D		A	B	C	D		A	B	C	D	
Tambor	294.8	296.5	334.6		Tambor	200.0	201.0	230.0		Tambor	295.0	296.5	335.5		Tambor	254.0	256.0	297.7	
E	F	G	H	I	E	F	G	H	I	E	F	G	H	I	E	F	G	H	I
60.0	80.0	101.0	14.0	6	38.8	57.5	57.0	12.5	4	76.5	96.6	78.7	16.3	6	50.0	69.0	60.0	14.3	5





A: Tipo
 B: Diámetro Nominal
 C: Diámetro Máximo
 D: Diámetro Exterior
 E: Ancho Pista
 F: Altura
 G: Diámetro de Piloto
 H: Diámetro del Birlo o Barreno
 I: Número de Birlos o Barrenos



BRD134210					BRD134310					BRD350110					BRD350210				
A	B	C	D		A	B	C	D		A	B	C	D		A	B	C	D	
Tambor	200.0	202.0	244.0		Tambor	230.0	232.0	274.0		Tambor	228.7	230.0	278.0		Tambor	203.3	204.5	233.5	
																			
E	F	G	H	I	E	F	G	H	I	E	F	G	H	I	E	F	G	H	I
42.5	62.5	60.0	14.0	4	47.0	63.0	60.0	14.0	5	51.2	76.0	66.0	13.0	4	50.5	76.0		M12X1.5	4





BRD350310					BRD350410					BRD370110					BRD370210				
A	B	C	D		A	B	C	D		A	B	C	D		A	B	C	D	
Tambor	227.5	229.2	260.0		Tambor	203.0	204.5	234.0		Tambor	200.0	201.5	240.0		Tambor	200.0	201.5	240.0	
																			
E	F	G	H	I	E	F	G	H	I	E	F	G	H	I	E	F	G	H	I
50.0	92.4		M12X1.5	5	47.0	76.0		M12 X 1.5	4	50.0	59.5	65.0	15.9	5	49.5	81.0		M12X1.5	4

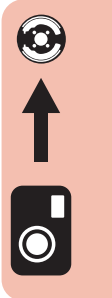

BRD370310					BRD370410					BRD370510					BRD370610				
A	B	C	D		A	B	C	D		A	B	C	D		A	B	C	D	
Tambor	180.0	181.0	210.0		Tambor	230.0	231.5	262.0		Tambor	252.0	253.5	282.0		Tambor	200.0	201.5	240.0	
																			
E	F	G	H	I	E	F	G	H	I	E	F	G	H	I	E	F	G	H	I
39.1	73.8		M12X1.5	4	50.0	94.3		M14X1.5	4	60.0	72.5	65.0	15.3	5	50.0	59.6	65.0	14.0	4





BRD370810					BRD370910					BRD371010					BRD371110				
A	B	C	D		A	B	C	D		A	B	C	D		A	B	C	D	
Tambor	230.0	231.5	290.0		Tambor	230.0	231.5	289.3		Tambor	230.0	231.5	289.3		Tambor	228.4	230.0	276.0	
																			
E	F	G	H	I	E	F	G	H	I	E	F	G	H	I	E	F	G	H	I
40.4	64.5	65.0	15.8	5	39.0	57.7	65.0	14.0	4	39.0	57.7	65.0	15.5	5	47.0	56.0	65.0	16.0	5







© Schaeffler Automotive Aftermarket México S. de R.L. de C.V. se reserva todos y cada uno de los derechos sobre las fotografías exclusivas de la marca aquí presentadas; se prohíbe la reproducción parcial y/o total, uso, modificación y distribución de cada una de estas fotografías

BRD371210					BRD380110					BRD380210					BRD390110				
A	B	C	D		A	B	C	D		A	B	C	D		A	B	C	D	
Tambor	295.0	296.5	335.5		Tambor	228.4	230.0	274.0		Tambor	180.0	181.0	212.0		Tambor	228.3	230.0	268.0	
																			
E	F	G	H	I	E	F	G	H	I	E	F	G	H	I	E	F	G	H	I
72.0	95.5	76.0	16.5	5	49.5	66.5	71.0	13.0	4	46.0	80.0	52.0	M12X1.5	4	47.0	61.0	59.0	14.0	4

BRD390410					BRD500110					BRD510110					BRD510210				
A	B	C	D		A	B	C	D		A	B	C	D		A	B	C	D	
Tambor	185.6	187.0	219.0		Tambor	228.5	230.0	274.0		Tambor	200.0	201.0	239.0		Tambor	200.0	201.0	250.0	
					Imagen no disponible														
E	F	G	H	I	E	F	G	H	I	E	F	G	H	I	E	F	G	H	I
36.5	49.0	59.0	14.0	4	50.0	63.0	76.0	13.0	5	42.5	59.0	61.0	12.8	4	40.0	55.5	64.2	12.7	5





BRD510510					BRD510610					BRD520710					BRD520810				
A	B	C	D		A	B	C	D		A	B	C	D		A	B	C	D	
Tambor	200.0	201.0	246.0		Tambor	200.0	201.0	246.0		Tambor	295.0	296.5	337.0		Tambor	180.0	181.0	220.0	
																			
E	F	G	H	I	E	F	G	H	I	E	F	G	H	I	E	F	G	H	I
41.3	63.5	61.0	12.6	4	39.0	54.0	61.0	12.7	4	68.3	89.0	100.5	12.7	6	35.5	57.9	67.8	12.6	4





BRD521310					BRD521510					BRD521610					BRD521710				
A	B	C	D		A	B	C	D		A	B	C	D		A	B	C	D	
Tambor	260.0	261.5	299.5		Tambor	203.0	204.5	236.2		Tambor	260.0	261.5	300.0		Tambor	203.0	204.5	239.0	
																			
E	F	G	H	I	E	F	G	H	I	E	F	G	H	I	E	F	G	H	I
62.0	72.5	100.5	12.7	6	42.4	66.5	68.1	12.7	4	63.5	73.3	100.5	12.6	6	42.0	66.0	68.0	13.0	4





A: Tipo
 B: Diámetro Nominal
 C: Diámetro Máximo
 D: Diámetro Exterior
 E: Ancho Pista
 F: Altura
 G: Diámetro de Piloto
 H: Diámetro del Birlo o Barreno
 I: Número de Birlos o Barrenos



BRD521810					BRD521910					BRD522010					BRD522110				
A	B	C	D		A	B	C	D		A	B	C	D		A	B	C	D	
Tambor	228.7	230.0	265.0		Tambor	203.0	204.2	255.7		Tambor	228.6	230.0	270.8		Tambor	203.3	204.5	204.5	
																			
E	F	G	H	I	E	F	G	H	I	E	F	G	H	I	E	F	G	H	I
50.0	60.5	68.0	12.8	4	48.5	75.0		12.7	4	51.3	59.8	68.0	12.9	5	50.0	59.7	61.0	12.8	4

BRD522210					BRD530110					BRD530310					BRD530410				
A	B	C	D		A	B	C	D		A	B	C	D		A	B	C	D	
Tambor	269.0	271.5	311.0		Tambor	200.0	201.0	241.9		Tambor	254.0	256.0	308.5		Tambor	228.5	229.6	272.0	
																			
E	F	G	H	I	E	F	G	H	I	E	F	G	H	I	E	F	G	H	I
69.0	86.0	68.0		6	40.0	52.7	55.0	14.7	5	61.0	72.0	106.0	14.5	6	46.0	55.2	55.0	14.9	5

BRD530510					BRD530610					BRD530710					BRD530810				
A	B	C	D		A	B	C	D		A	B	C	D		A	B	C	D	
Tambor	200.0	201.0	252.0		Tambor	253.8	256.0	303.2		Ventilado	254.0	256.0	306.0		Tambor	295.0	297.0	344.5	
																			
E	F	G	H	I	E	F	G	H	I	E	F	G	H	I	E	F	G	H	I
41.0	53.0	55.0	14.5	4	62.0	73.9	62.0	14.6	5	61.7	73.7	108.0	14.5	6	66.5	77.0	108.0	14.5	6

BRD530910					BRD531010					BRD536050					BRD540510				
A	B	C	D		A	B	C	D		A	B	C	D		A	B	C	D	
Ventilado	203.0	204.0	240.0		Ventilado	295.0	297.0	343.0		Ventilado	294.7	297.0	343.0		Ventilado	295.0	297.0	343.0	
																			
E	F	G	H	I	E	F	G	H	I	E	F	G	H	I	E	F	G	H	I
49.4	60.0	60.0	13.0	4	65.0	83.0	107.0	14.4	6	66.0	84.0	105.8	14.5	6	64.0	91.4	94.0	12.2	6



© Schaeffler Automotive Aftermarket México S. de R.L. de C.V. se reserva todos y cada uno de los derechos sobre las fotografías exclusivas de la marca aquí presentadas; se prohíbe la reproducción parcial y/o total, uso, modificación y distribución de cada una de estas fotografías

BRD560210					BRD560310				
A	B	C	D		A	B	C	D	
Ventilado	254.0	256.0	301.5		Tambor	200.0	202.0	238.0	
									
E	F	G	H	I	E	F	G	H	I
47.3	61.0	62.0	12.7	5	40.5	81.5		12.0	4



A: Tipo
 B: Diámetro Nominal
 C: Diámetro Máximo
 D: Diámetro Exterior
 E: Ancho Pista
 F: Altura
 G: Diámetro de Piloto
 H: Diámetro del Birlo o Barreno
 I: Número de Birlos o Barrenos

SEGURIDAD.







FAG



**Zapatas de Freno FAG:
Diseño y manufactura con
especificaciones de Equipo Original
Formulación FAG NAO**





REPERT.MX
Servicio Técnico: 800 8000 585
Lun - Vier 9:00 a 18:00
servicio.tecnico@schaeffler.com
info@rexpert.mx
www.rexpert.mx
www.schaeffler.mx

SCHAEFFLER

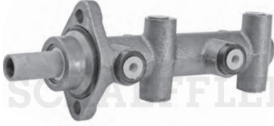
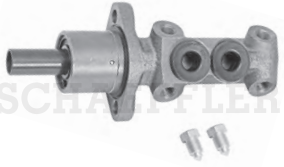
BMC10101		BMC10102		BMC10103		BMC10104	
Referencia	Diámetro	Referencia	Diámetro	Referencia	Diámetro	Referencia	Diámetro
MC39736	22.2 - 7/8"	MC39578	29.0 & 40.0	MC390234	23.8 - 15/16"	MC390336	31.7 - 1 1/4"
							
No. de puertos	Marca	No. de puertos	Marca	No. de puertos	Marca	No. de puertos	Marca
2	CHRYSLER	2	CHEVROLET	4	NISSAN	2	FORD, LINCOLN

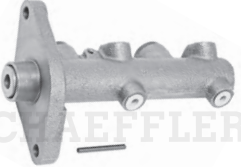
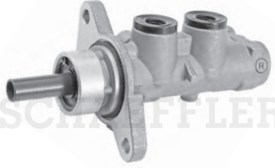
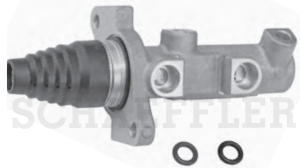

BMC10105		BMC10106		BMC10107		BMC10108	
Referencia	Diámetro	Referencia	Diámetro	Referencia	Diámetro	Referencia	Diámetro
390700RL	20.6 - 13/16"	390801	20.6 - 13/16"	390901	20.6 - 13/16"	390931	22.2 - 7/8"
							
No. de puertos	Marca	No. de puertos	Marca	No. de puertos	Marca	No. de puertos	Marca
4	PEUGEOT	4	CHEVROLET	4	VOLKSWAGEN	4	VOLKSWAGEN

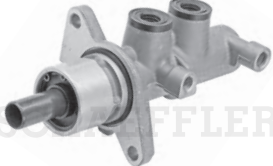
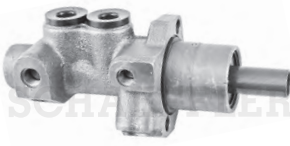
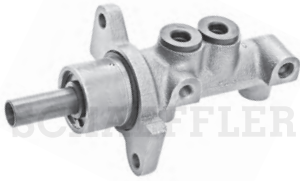
BMC10109		BMC10110		BMC10111		BMC10112	
Referencia	Diámetro	Referencia	Diámetro	Referencia	Diámetro	Referencia	Diámetro
390951	20.6 - 13/16"	39009904	23.8 - 15/16"	LC3495064	22.2 - 7/8"	MC390720	25.4 - 1"
							
No. de puertos	Marca	No. de puertos	Marca	No. de puertos	Marca	No. de puertos	Marca
3	VOLKSWAGEN	4	FORD	2	CHEVROLET	2	DODGE



BMC10114		BMC10115		BMC10116		BMC10117	
Referencia	Diámetro	Referencia	Diámetro	Referencia	Diámetro	Referencia	Diámetro
5083353	20.6 - 13/16"	9193225	23.8 - 15/16"	39009902	20.6 - 13/16"	39009903	22.2 - 7/8"
							
No. de puertos	Marca	No. de puertos	Marca	No. de puertos	Marca	No. de puertos	Marca
4	DODGE	2	CHEVROLET	4	CHEVROLET	4	CHEVROLET

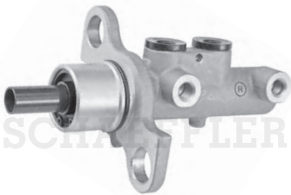
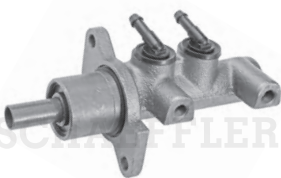
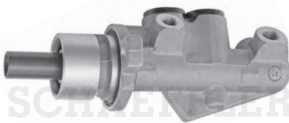



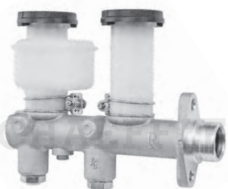
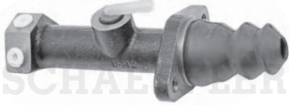
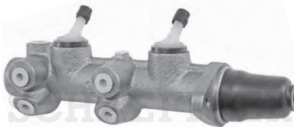

© Schaeffler Automotive Aftermarket México S. de R.L. de C.V. se reserva todos y cada uno de los derechos sobre las fotografías exclusivas de la marca aquí presentadas; se prohíbe la reproducción parcial y/o total, uso, modificación y distribución de cada una de estas fotografías

BMC10118		BMC10119		BMC10120		BMC10121	
Referencia	Diámetro	Referencia	Diámetro	Referencia	Diámetro	Referencia	Diámetro
93172089	25.4 - 1"	93305031	23.8 - 15/16"	4601000Q	20.6 - 13/16"	460108B6	25.4 - 1"
							
No. de puertos	Marca	No. de puertos	Marca	No. de puertos	Marca	No. de puertos	Marca
2	CHEVROLET	2	CHEVROLET	4	NISSAN	460108B6	25.4 - 1"



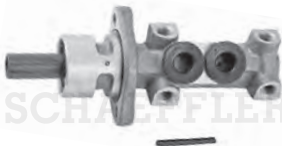

BMC10122		BMC10123		BMC10124		BMC10125	
Referencia	Diámetro	Referencia	Diámetro	Referencia	Diámetro	Referencia	Diámetro
46010A05	19.0 & 23.8	39592	23.8 - 15/16"	46010J01	22.2 - 7/8"	39009910	25.4 - 1"
							
No. de puertos	Marca	No. de puertos	Marca	No. de puertos	Marca	No. de puertos	Marca
2	NISSAN	2	NISSAN	2	NISSAN	2	NISSAN





BMC10126		BMC10128		BMC10129		BMC10130	
Referencia	Diámetro	Referencia	Diámetro	Referencia	Diámetro	Referencia	Diámetro
46010W87	22.2 - 7/8"	MC36272	17.4 - 11/16"	MC36275	19.0 - 3/4"	MC36306	28.5 - 1 1/8"
							
No. de puertos	Marca	No. de puertos	Marca	No. de puertos	Marca	No. de puertos	Marca
2	NISSAN	4	VOLKSWAGEN	5	VOLKSWAGEN	2	DINA





BMC10131		BMC10133		BMC10134		BMC10135	
Referencia	Diámetro	Referencia	Diámetro	Referencia	Diámetro	Referencia	Diámetro
MC390006	19.0 - 3/4"	MC390056	22.2 - 7/8"	MC39736	22.2 - 7/8"	MC390071	25.4 - 1"
							
No. de puertos	Marca	No. de puertos	Marca	No. de puertos	Marca	No. de puertos	Marca
4	NISSAN	2	CHEVROLET	4	VOLKSWAGEN, SEAT	2	JEEP





© Schaeffler Automotive Aftermarket México S. de R.L. de C.V. se reserva todos y cada uno de los derechos sobre las fotografías exclusivas de la marca aquí presentadas; se prohíbe la reproducción parcial y/o total, uso, modificación y distribución de cada una de estas fotografías



BMC10136		BMC10137		BMC10138		BMC10140	
Referencia	Diámetro	Referencia	Diámetro	Referencia	Diámetro	Referencia	Diámetro
MC39011	25.4 - 1"	MC390115	25.4 - 1"	MC390116	25.4 - 1"	MC39016	23.8 - 15/16"
							
No. de puertos	Marca	No. de puertos	Marca	No. de puertos	Marca	No. de puertos	Marca
2	FORD	2	MERCURY, NISSAN	2	MERCURY, NISSAN	2	CHEVROLET



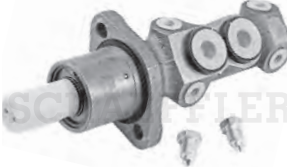

BMC10145		BMC10146		BMC10148		BMC10149	
Referencia	Diámetro	Referencia	Diámetro	Referencia	Diámetro	Referencia	Diámetro
MC390182	28.5 - 1 1/8"	MC390183	26.9 - 1 1/16"	MC390204	21.0 - 53/64"	MC390213	22.2 - 7/8"
							
No. de puertos	Marca	No. de puertos	Marca	No. de puertos	Marca	No. de puertos	Marca
3	FORD	2	FORD	4	DODGE	4	DODGE





BMC10153		BMC10154		BMC10156		BMC10158	
Referencia	Diámetro	Referencia	Diámetro	Referencia	Diámetro	Referencia	Diámetro
MC390248	26.9 - 1 1/16"	MC390251	22.2 - 7/8"	MC390257	31.7 - 1 1/4"	MC390259	28.5 - 1 1/8"
							
No. de puertos	Marca	No. de puertos	Marca	No. de puertos	Marca	No. de puertos	Marca
2	FORD	4	CHRYSLER, DODGE	2	CHEVROLET, DODGE	2	CHEVROLET, CADILLAC

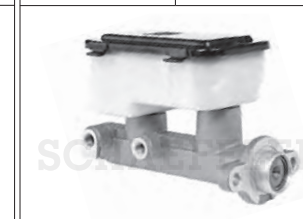



BMC10159		BMC10160		BMC10161		BMC10162	
Referencia	Diámetro	Referencia	Diámetro	Referencia	Diámetro	Referencia	Diámetro
MC390268	26.9 - 1 1/16"	MC390269	26.9 - 1 1/16"	MC39877	22.2 - 7/8"	MC390275	23.8 - 15/16"
							
No. de puertos	Marca	No. de puertos	Marca	No. de puertos	Marca	No. de puertos	Marca
3	FORD	2	FORD	4	VOLKSWAGEN	2	CHRYSLER





© Schaeffler Automotive Aftermarket México S. de R.L. de C.V. se reserva todos y cada uno de los derechos sobre las fotografías exclusivas de la marca aquí presentadas; se prohíbe la reproducción parcial y/o total, uso, modificación y distribución de cada una de estas fotografías

BMC10163		BMC10164		BMC10165		BMC10166	
Referencia	Diámetro	Referencia	Diámetro	Referencia	Diámetro	Referencia	Diámetro
MC390277	22.2 - 7/8"	MC390278	40	MC390279	31.7 - 1 1/4"	MC390303	25.4 - 1"
							
No. de puertos	Marca	No. de puertos	Marca	No. de puertos	Marca	No. de puertos	Marca
4	CHEVROLET	2	CHEVROLET	2	CHEVROLET	2	JEEP





BMC10167		BMC10168		BMC10169		BMC10170	
Referencia	Diámetro	Referencia	Diámetro	Referencia	Diámetro	Referencia	Diámetro
MC390317	20.6 - 13/16"	MC390318	22.2 - 7/8"	MC390319	22.2 - 7/8"	MC390320	24.0 & 36.0
							
No. de puertos	Marca	No. de puertos	Marca	No. de puertos	Marca	No. de puertos	Marca
2	NISSAN	2	NISSAN	2	NISSAN	2	CHEVROLET



BMC10171		BMC10173		BMC10174		BMC10175	
Referencia	Diámetro	Referencia	Diámetro	Referencia	Diámetro	Referencia	Diámetro
MC390321	31.7 - 1 1/4"	MC390337	31.7 - 1 1/4"	MC390338	31.7 - 1 1/4"	MC390339	31.7 - 1 1/4"
							
No. de puertos	Marca	No. de puertos	Marca	No. de puertos	Marca	No. de puertos	Marca
2	CHEVROLET	2	FORD	2	FORD	2	FORD





BMC10177		BMC10178		BMC10179		BMC10180	
Referencia	Diámetro	Referencia	Diámetro	Referencia	Diámetro	Referencia	Diámetro
MC390343	25.4 - 1"	MC390363	28.5 - 1 1/8"	MC390364	31.7 - 1 1/4"	MC39037	22.2 - 7/8"
							
No. de puertos	Marca	No. de puertos	Marca	No. de puertos	Marca	No. de puertos	Marca
2	NISSAN	2	CHEVROLET	2	CHEVROLET	2	FORD





© Schaeffler Automotive Aftermarket México S. de R.L. de C.V. se reserva todos y cada uno de los derechos sobre las fotografías exclusivas de la marca aquí presentadas; se prohíbe la reproducción parcial y/o total, uso, modificación y distribución de cada una de estas fotografías



BMC10181		BMC10182		BMC10183		BMC10184	
Referencia	Diámetro	Referencia	Diámetro	Referencia	Diámetro	Referencia	Diámetro
MC390370	25.4 - 1"	MC390371	25.4 - 1"	MC390377	23.8 - 15/16"	MC390378	25.4 - 1"
							
No. de puertos	Marca	No. de puertos	Marca	No. de puertos	Marca	No. de puertos	Marca
2	FORD	4	CHEVROLET	2	CHRYSLER	2	DODGE



BMC10185		BMC10186		BMC10187		BMC10189	
Referencia	Diámetro	Referencia	Diámetro	Referencia	Diámetro	Referencia	Diámetro
MC390386	25.4 - 1"	MC390392	28.5 - 1 1/8"	MC390394	31.7 - 1 1/4"	MC390398	26.9 - 1 1/16"
							
No. de puertos	Marca	No. de puertos	Marca	No. de puertos	Marca	No. de puertos	Marca
2	CHEVROLET	2	FORD	3	FORD	2	FORD, LINCOLN





BMC10190		BMC10191		BMC10192		BMC10196	
Referencia	Diámetro	Referencia	Diámetro	Referencia	Diámetro	Referencia	Diámetro
MC390399	26.9 - 1 1/16"	MC390400	26.9 - 1 1/16"	MC390401	25.4 - 1"	MC390426	31.7 - 1 1/4"
							
No. de puertos	Marca	No. de puertos	Marca	No. de puertos	Marca	No. de puertos	Marca
2	FORD	2	FORD	2	CHEVROLET, PONTIAC	2	DODGE

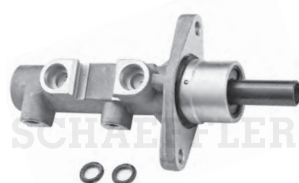

BMC10197		BMC10198		BMC10199		BMC10200	
Referencia	Diámetro	Referencia	Diámetro	Referencia	Diámetro	Referencia	Diámetro
MC390427	25.4 - 1"	MC390440	23.8 - 15/16"	MC390447	23.8 - 15/16"	MC390449	23.8 - 15/16"
							
No. de puertos	Marca	No. de puertos	Marca	No. de puertos	Marca	No. de puertos	Marca
2	CHEVROLET	2	CHRYSLER, DODGE	2	FORD	2	FORD





© Schaeffler Automotive Aftermarket México S. de R.L. de C.V. se reserva todos y cada uno de los derechos sobre las fotografías exclusivas de la marca aquí presentadas; se prohíbe la reproducción parcial y/o total, uso, modificación y distribución de cada una de estas fotografías

BMC10201		BMC10202		BMC10203		BMC10204	
Referencia	Diámetro	Referencia	Diámetro	Referencia	Diámetro	Referencia	Diámetro
MC390463	25.4 - 1"	MC390500	23.8 - 15/16"	MC390508	28.5 - 1 1/8"	MC390511	25.4 - 1"
							
No. de puertos	Marca	No. de puertos	Marca	No. de puertos	Marca	No. de puertos	Marca
4	FORD, MERCURY	2	VOLKSWAGEN, AUDI	2	DODGE	2	JEEP



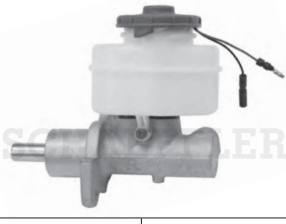
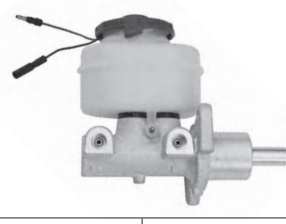

BMC10205		BMC10206		BMC10207		BMC10210	
Referencia	Diámetro	Referencia	Diámetro	Referencia	Diámetro	Referencia	Diámetro
MC390514	23.8 - 15/16"	MC390515	23.8 - 15/16"	MC390516	31.7 - 1 1/4"	MC390526	33.3 - 1 5/16"
							
No. de puertos	Marca	No. de puertos	Marca	No. de puertos	Marca	No. de puertos	Marca
2	FORD	2	FORD	2	CHRYSLER, DODGE	2	FORD





BMC10211		BMC10212		BMC10215		BMC10216	
Referencia	Diámetro	Referencia	Diámetro	Referencia	Diámetro	Referencia	Diámetro
MC390530	34.9 - 1 3/8"	MC390531	34.9 - 1 3/8"	MC390541	34	MC390542	37
							
No. de puertos	Marca	No. de puertos	Marca	No. de puertos	Marca	No. de puertos	Marca
3	FORD	2	FORD	2	CHEVROLET	2	CADILLAC





BMC10217		BMC10218		BMC10219		BMC10220	
Referencia	Diámetro	Referencia	Diámetro	Referencia	Diámetro	Referencia	Diámetro
MC390546	23.8 - 15/16"	MC390551	26.9 - 1 1/16"	MC390556	26.9 - 1 1/16"	MC390569	25.4 - 1"
							
No. de puertos	Marca	No. de puertos	Marca	No. de puertos	Marca	No. de puertos	Marca
4	CHEVROLET	2	HONDA	2	HONDA	2	LINCOLN, MERCURY



© Schaeffler Automotive Aftermarket México S. de R.L. de C.V. se reserva todos y cada uno de los derechos sobre las fotografías exclusivas de la marca aquí presentadas; se prohíbe la reproducción parcial y/o total, uso, modificación y distribución de cada una de estas fotografías



BMC10222		BMC10224		BMC10225		BMC10226	
Referencia	Diámetro	Referencia	Diámetro	Referencia	Diámetro	Referencia	Diámetro
MC390571	25.4 - 1"	MC390577	23.8 - 15/16"	MC390579	22.2 - 7/8"	MC390581	25.4 - 1"
							
No. de puertos	Marca	No. de puertos	Marca	No. de puertos	Marca	No. de puertos	Marca
2	CHEVROLET	2	CHRYSLER, DODGE	3	DODGE	2	FORD



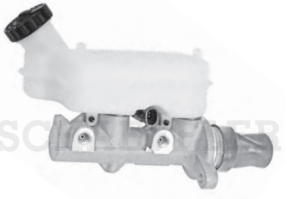

BMC10227		BMC10228		BMC10230		BMC10231	
Referencia	Diámetro	Referencia	Diámetro	Referencia	Diámetro	Referencia	Diámetro
MC390582	25.4 - 1"		20.6 - 13/16"	MC390638	23.8 - 15/16"	MC390643	23.8 - 15/16"
							
No. de puertos	Marca	No. de puertos	Marca	No. de puertos	Marca	No. de puertos	Marca
2	FORD	4	VOLKSWAGEN	3	CHRYSLER	4	FORD





BMC10232		BMC10235		BMC10236		BMC10237	
Referencia	Diámetro	Referencia	Diámetro	Referencia	Diámetro	Referencia	Diámetro
MC390646	22.2 - 7/8"	MC390676	23.8 - 15/16"	MC390678	23.8 - 15/16"	MC390690	25.4 - 1"
							
No. de puertos	Marca	No. de puertos	Marca	No. de puertos	Marca	No. de puertos	Marca
2	CHEVROLET	2	CHEVROLET	4	FORD	2	FORD

BMC10239		BMC10240		BMC10241		BMC10242	
Referencia	Diámetro	Referencia	Diámetro	Referencia	Diámetro	Referencia	Diámetro
MC390697	25.4 - 1"	MC390707	23.8 - 15/16"	MC390708	23.8 - 15/16"	MC390709	26.9 - 1 1/16"
							
No. de puertos	Marca	No. de puertos	Marca	No. de puertos	Marca	No. de puertos	Marca
2	CHEVROLET, GMC	2	CHEVROLET	2	CHRYSLER	2	CHRYSLER







© Schaeffler Automotive Aftermarket México S. de R.L. de C.V. se reserva todos y cada uno de los derechos sobre las fotografías exclusivas de la marca aquí presentadas; se prohíbe la reproducción parcial y/o total, uso, modificación y distribución de cada una de estas fotografías

BMC10243		BMC10244		BMC10246		BMC10247	
Referencia	Diámetro	Referencia	Diámetro	Referencia	Diámetro	Referencia	Diámetro
MC390710	26.9 - 1 1/16"	MC390712	26.9 - 1 1/16"	MC390721	23.8 - 15/16"	MC390724	22.2 - 7/8"
							
No. de puertos	Marca	No. de puertos	Marca	No. de puertos	Marca	No. de puertos	Marca
2	CHRYSLER	2	JEEP	2	HONDA	4	DODGE





BMC10248		BMC10249		BMC10250		BMC10251	
Referencia	Diámetro	Referencia	Diámetro	Referencia	Diámetro	Referencia	Diámetro
MC390734	20.6 - 13/16"	MC390735	20.6 - 13/16"	MC390739	25.4 - 1"	MC390742	33.3 - 1 5/16"
							
No. de puertos	Marca	No. de puertos	Marca	No. de puertos	Marca	No. de puertos	Marca
2	TOYOTA	2	TOYOTA	2	PONTIAC	2	DODGE



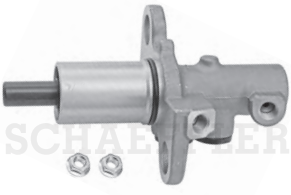

BMC10253		BMC10254		BMC10255		BMC10256	
Referencia	Diámetro	Referencia	Diámetro	Referencia	Diámetro	Referencia	Diámetro
MC390746	20.6 - 13/16"	MC390747	23.8 - 15/16"	MC390748	23.8 - 15/16"	MC390749	23.8 - 15/16"
							
No. de puertos	Marca	No. de puertos	Marca	No. de puertos	Marca	No. de puertos	Marca
2	HONDA	2	NISSAN	2	NISSAN	4	NISSAN





BMC10257		BMC10260		BMC10261		BMC10262	
Referencia	Diámetro	Referencia	Diámetro	Referencia	Diámetro	Referencia	Diámetro
MC390752	22.2 - 7/8"	MC390762	28.5 - 1 1/8"	MC390763	28.5 - 1 1/8"	MC390774	25.4 - 1"
							
No. de puertos	Marca	No. de puertos	Marca	No. de puertos	Marca	No. de puertos	Marca
2	TOYOTA	2	FORD	2	FORD	2	NISSAN



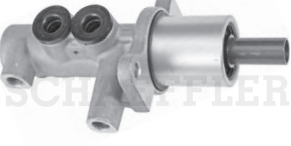

© Schaeffler Automotive Aftermarket México S. de R.L. de C.V. se reserva todos y cada uno de los derechos sobre las fotografías exclusivas de la marca aquí presentadas; se prohíbe la reproducción parcial y/o total, uso, modificación y distribución de cada una de estas fotografías

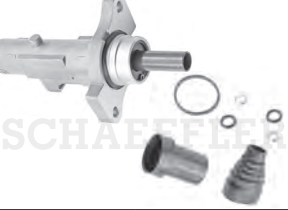

BMC10263		BMC10264		BMC10265		BMC10266	
Referencia	Diámetro	Referencia	Diámetro	Referencia	Diámetro	Referencia	Diámetro
MC390778	25.4 - 1"	MC390784	20.6 - 13/16"	MC391304	22.2 - 7/8"	MC390800	23.8 - 15/16"
							
No. de puertos	Marca	No. de puertos	Marca	No. de puertos	Marca	No. de puertos	Marca
2	VOLKSWAGEN, AUDI	2	HONDA	2	NISSAN	4	NISSAN



BMC10267		BMC10268		BMC10269		BMC10271	
Referencia	Diámetro	Referencia	Diámetro	Referencia	Diámetro	Referencia	Diámetro
MC390804	34	MC390805	31.7 - 1 1/4"	MC390806	31.7 - 1 1/4"	MC390808	22.2 - 7/8"
							
No. de puertos	Marca	No. de puertos	Marca	No. de puertos	Marca	No. de puertos	Marca
2	CHEVROLET, CADILLAC	2	CHEVROLET, CADILLAC	2	CHEVROLET, CADILLAC	2	HONDA





BMC10272		BMC10273		BMC10274		BMC10275	
Referencia	Diámetro	Referencia	Diámetro	Referencia	Diámetro	Referencia	Diámetro
MC390810	26.9 - 1 1/16"	MC390811	28.5 - 1 1/8"	MC390816	23.8 - 15/16"	MC390818	37
							
No. de puertos	Marca	No. de puertos	Marca	No. de puertos	Marca	No. de puertos	Marca
3	FORD	2	FORD, LINCOLN	2	DODGE	2	CHEVROLET





BMC10276		BMC10278		BMC10279		BMC10280	
Referencia	Diámetro	Referencia	Diámetro	Referencia	Diámetro	Referencia	Diámetro
MC390819	23.8 - 15/16"	MC390821	33.3 - 1 5/16"	MC390823	25.4 - 1"	MC390833	20.6 - 13/16"
							
No. de puertos	Marca	No. de puertos	Marca	No. de puertos	Marca	No. de puertos	Marca
2	FORD	2	DODGE	2	CHRYSLER	2	TOYOTA



© Schaeffler Automotive Aftermarket México S. de R.L. de C.V. se reserva todos y cada uno de los derechos sobre las fotografías exclusivas de la marca aquí presentadas; se prohíbe la reproducción parcial y/o total, uso, modificación y distribución de cada una de estas fotografías



BMC10281		BMC10282		BMC10283		BMC10285	
Referencia	Diámetro	Referencia	Diámetro	Referencia	Diámetro	Referencia	Diámetro
MC390835	25.4 - 1"	MC390843	34	MC390845	25.4 - 1"	MC390849	31.7 - 1 1/4"
							
No. de puertos	Marca	No. de puertos	Marca	No. de puertos	Marca	No. de puertos	Marca
2	NISSAN	2	CHEVROLET	2	CHEVROLET, GMC	2	FORD





BMC10286		BMC10287		BMC10288		BMC10289	
Referencia	Diámetro	Referencia	Diámetro	Referencia	Diámetro	Referencia	Diámetro
MC390852	31.7 - 1 1/4"	MC390853	31.7 - 1 1/4"	MC390854	25.4 - 1"	MC390855	25.4 - 1"
							
No. de puertos	Marca	No. de puertos	Marca	No. de puertos	Marca	No. de puertos	Marca
2	DODGE	2	DODGE	2	NISSAN	2	NISSAN





BMC10290		BMC10291		BMC10292		BMC10293	
Referencia	Diámetro	Referencia	Diámetro	Referencia	Diámetro	Referencia	Diámetro
MC390857	22.2 - 7/8"	MC390858	23.8 - 15/16"	MC390859	23.8 - 15/16"	39009912	19.0 - 3/4"
							
No. de puertos	Marca	No. de puertos	Marca	No. de puertos	Marca	No. de puertos	Marca
2	TOYOTA	2	NISSAN	2	NISSAN	2	VOLKSWAGEN





BMC10294		BMC10295		BMC10296		BMC10297	
Referencia	Diámetro	Referencia	Diámetro	Referencia	Diámetro	Referencia	Diámetro
MC390866	28.5 - 1 1/8"	MC390867	25.4 - 1"	MC390870	19.0 - 3/4"	MC390875	25.4 - 1"
							
No. de puertos	Marca	No. de puertos	Marca	No. de puertos	Marca	No. de puertos	Marca
4	NISSAN	2	NISSAN	2	TOYOTA	2	NISSAN





© Schaeffler Automotive Aftermarket México S. de R.L. de C.V. se reserva todos y cada uno de los derechos sobre las fotografías exclusivas de la marca aquí presentadas; se prohíbe la reproducción parcial y/o total, uso, modificación y distribución de cada una de estas fotografías



BMC10298		BMC10299		BMC10300		BMC10301	
Referencia	Diámetro	Referencia	Diámetro	Referencia	Diámetro	Referencia	Diámetro
MC390879	28.5 - 1 1/8"	MC390885	23.8 - 15/16"	MC390886	25.4 - 1"	MC390909	26.9 - 1 1/16"
							
No. de puertos	Marca	No. de puertos	Marca	No. de puertos	Marca	No. de puertos	Marca
2	NISSAN	2	CHEVROLET	2	MITSUBISHI	2	FORD





BMC10302		BMC10303		BMC10304		BMC10305	
Referencia	Diámetro	Referencia	Diámetro	Referencia	Diámetro	Referencia	Diámetro
MC390910	25.4 - 1"	MC390919	25.4 - 1"	MC390922	25.4 - 1"	MC390926	28.5 - 1 1/8"
							
No. de puertos	Marca	No. de puertos	Marca	No. de puertos	Marca	No. de puertos	Marca
2	FORD, MERCURY	2	FORD, MERCURY	2	FORD, MERCURY	2	DODGE



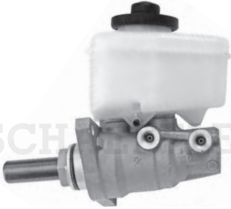

BMC10306		BMC10307		BMC10308		BMC10309	
Referencia	Diámetro	Referencia	Diámetro	Referencia	Diámetro	Referencia	Diámetro
MC390927	28.5 - 1 1/8"	MC390930	28.5 - 1 1/8"	MC390933	23.8 - 15/16"	MC390956	38.1 - 1 1/2"
							
No. de puertos	Marca	No. de puertos	Marca	No. de puertos	Marca	No. de puertos	Marca
2	DODGE	2	CHEVROLET, GMC	2	CHEVROLET	2	FORD



BMC10310		BMC10311		BMC10312		BMC10313	
Referencia	Diámetro	Referencia	Diámetro	Referencia	Diámetro	Referencia	Diámetro
MC390957	33.3 - 1 5/16"	MC390958	26.9 - 1 1/16"	MC390960	25.4 - 1"	MC390964	20.6 - 13/16"
							
No. de puertos	Marca	No. de puertos	Marca	No. de puertos	Marca	No. de puertos	Marca
3	FORD	2	FORD	2	FORD, MERCURY	2	TOYOTA



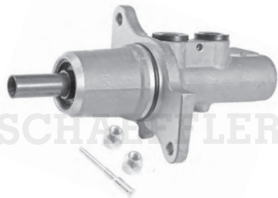
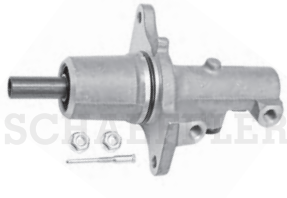

© Schaeffler Automotive Aftermarket México S. de R.L. de C.V. se reserva todos y cada uno de los derechos sobre las fotografías exclusivas de la marca aquí presentadas; se prohíbe la reproducción parcial y/o total, uso, modificación y distribución de cada una de estas fotografías

BMC10314		BMC10315		BMC10316		BMC10317	
Referencia	Diámetro	Referencia	Diámetro	Referencia	Diámetro	Referencia	Diámetro
MC390965	20.6 - 13/16"		22.2 - 7/8"		23.8 - 15/16"		22.2 - 7/8"
							
No. de puertos	Marca	No. de puertos	Marca	No. de puertos	Marca	No. de puertos	Marca
2	TOYOTA	2	NISSAN	2	FORD	2	CHEVROLET

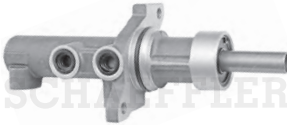
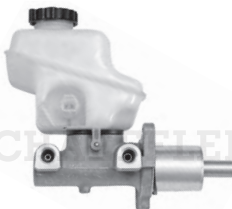

BMC10318		BMC10319		BMC10320		BMC10321	
Referencia	Diámetro	Referencia	Diámetro	Referencia	Diámetro	Referencia	Diámetro
MC390970	22.2 - 7/8"	MC390975	23.8 - 15/16"	MC390976	31.7 - 1 1/4"	MC390977	25.4 - 1"
							
No. de puertos	Marca	No. de puertos	Marca	No. de puertos	Marca	No. de puertos	Marca
2	TOYOTA	2	CHRYSLER	2	DODGE	2	CHRYSLER, DODGE





BMC10323		BMC10324		BMC10325		BMC10326	
Referencia	Diámetro	Referencia	Diámetro	Referencia	Diámetro	Referencia	Diámetro
MC390979	23.8 - 15/16"	MC390980	25.4 - 1"	MC390983	26.9 - 1 1/16"	MC390985	22.2 - 7/8"
							
No. de puertos	Marca	No. de puertos	Marca	No. de puertos	Marca	No. de puertos	Marca
2	MERCEDES	2	MERCEDES	2	CHEVROLET, GMC	2	PONTIAC



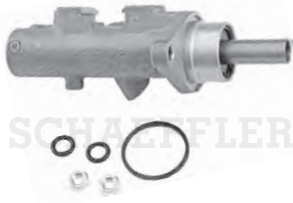

BMC10327		BMC10328		BMC10329		BMC10330	
Referencia	Diámetro	Referencia	Diámetro	Referencia	Diámetro	Referencia	Diámetro
MC390986	31.7 - 1 1/4"	MC390988	26.9 - 1 1/16"	MC390991	25.4 - 1"	MC390996	25.4 - 1"
							
No. de puertos	Marca	No. de puertos	Marca	No. de puertos	Marca	No. de puertos	Marca
2	CHEVROLET, CADILLAC	2	MERCEDES	2	CHRYSLER, DODGE	2	NISSAN



© Schaeffler Automotive Aftermarket México S. de R.L. de C.V. se reserva todos y cada uno de los derechos sobre las fotografías exclusivas de la marca aquí presentadas; se prohíbe la reproducción parcial y/o total, uso, modificación y distribución de cada una de estas fotografías



BMC10331		BMC10332		BMC10333		BMC10334	
Referencia	Diámetro	Referencia	Diámetro	Referencia	Diámetro	Referencia	Diámetro
MC390997	22.2 - 7/8"	MC390998	25.4 - 1"	MC391000	22.2 - 7/8"	MC391001	26.9 - 1 1/16"
							
No. de puertos	Marca	No. de puertos	Marca	No. de puertos	Marca	No. de puertos	Marca
2	HONDA	2	HONDA	2	HONDA	2	JEEP

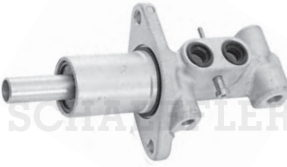
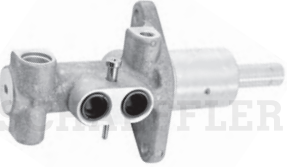

BMC10335		BMC10336		BMC10337		BMC10338	
Referencia	Diámetro	Referencia	Diámetro	Referencia	Diámetro	Referencia	Diámetro
MC391002	19.0 - 3/4"	MC391004	22.2 - 7/8"	MC391006	20.6 - 13/16"	MC391005	20.6 - 13/16"
							
No. de puertos	Marca	No. de puertos	Marca	No. de puertos	Marca	No. de puertos	Marca
2	HONDA	2	ACURA, HONDA	2	TOYOTA	2	TOYOTA

BMC10339		BMC10340		BMC10341		BMC10343	
Referencia	Diámetro	Referencia	Diámetro	Referencia	Diámetro	Referencia	Diámetro
MC391007	26.9 - 1 1/16"	MC391010	25.4 - 1"	MC391012	26.9 - 1 1/16"	MC391022	22.2 - 7/8"
							
No. de puertos	Marca	No. de puertos	Marca	No. de puertos	Marca	No. de puertos	Marca
2	HONDA	2	CHEVROLET	2	JEEP	4	DODGE



BMC10344		BMC10345		BMC10346		BMC10347	
Referencia	Diámetro	Referencia	Diámetro	Referencia	Diámetro	Referencia	Diámetro
MC391024	22.2 - 7/8"	MC391026	37	MC391031	22.2 - 7/8"	MC391032	22.2 - 7/8"
							
No. de puertos	Marca	No. de puertos	Marca	No. de puertos	Marca	No. de puertos	Marca
2	DODGE	2	CHEVROLET	2	CHRYSLER	3	CHRYSLER

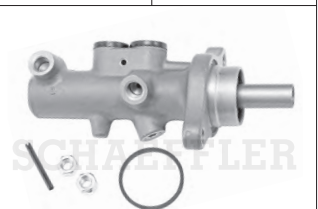



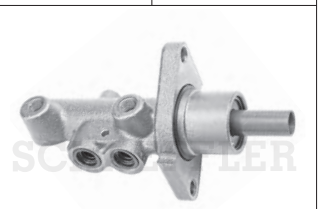
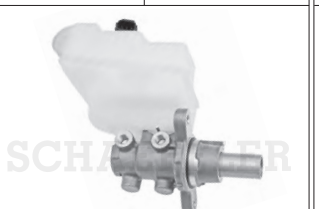
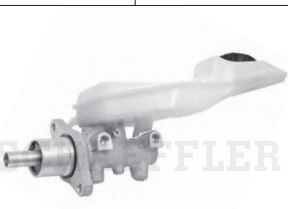

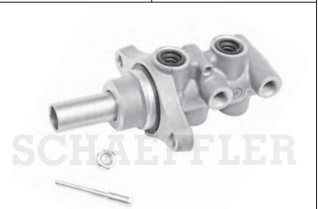
© Schaeffler Automotive Aftermarket México S. de R.L. de C.V. se reserva todos y cada uno de los derechos sobre las fotografías exclusivas de la marca aquí presentadas; se prohíbe la reproducción parcial y/o total, uso, modificación y distribución de cada una de estas fotografías

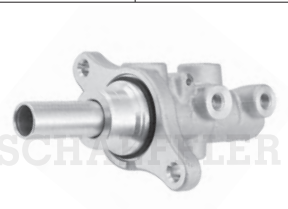
BMC10348		BMC10349		BMC10350		BMC10351	
Referencia	Diámetro	Referencia	Diámetro	Referencia	Diámetro	Referencia	Diámetro
	33.3 - 1 5/16"	MC391036	26.9 - 1 1/16"	MC391041	26.9 - 1 1/16"	MC391042	38.1 - 1 1/2"
							
No. de puertos	Marca	No. de puertos	Marca	No. de puertos	Marca	No. de puertos	Marca
2	DODGE	2	VW	3	FORD	2	FORD

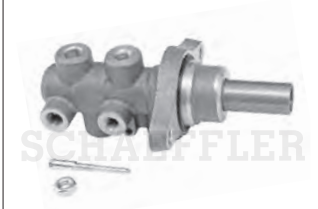

BMC10352		BMC10353		BMC10354		BMC10355	
Referencia	Diámetro	Referencia	Diámetro	Referencia	Diámetro	Referencia	Diámetro
MC391043	33.3 - 1 5/16"		23.8 - 15/16"		25.4 - 1"	MC391049	25.4 - 1"
							
No. de puertos	Marca	No. de puertos	Marca	No. de puertos	Marca	No. de puertos	Marca
4	FORD	2	FORD	2	FORD	2	MAZDA

BMC10356		BMC10357		BMC10358		BMC10359	
Referencia	Diámetro	Referencia	Diámetro	Referencia	Diámetro	Referencia	Diámetro
MC391050	23.8 - 15/16"	MC391066	20.6 - 13/16"	MC391068	25.4 - 1"	MC391069	20.6 - 13/16"
							
No. de puertos	Marca	No. de puertos	Marca	No. de puertos	Marca	No. de puertos	Marca
2	NISSAN	2	DODGE, JEEP	2	JEEP	2	FORD, MERCURY





BMC10360		BMC10361		BMC10362		BMC10363	
Referencia	Diámetro	Referencia	Diámetro	Referencia	Diámetro	Referencia	Diámetro
MC391071	20.6 - 13/16"		30.1 - 1 3/16"	MC391072	30.1 - 1 3/16"	MC391080	28.5 - 1 1/8"
							
No. de puertos	Marca	No. de puertos	Marca	No. de puertos	Marca	No. de puertos	Marca
4	DODGE	4	NISSAN, INFINITI	4	NISSAN, INFINITI	2	CHEVROLET





© Schaeffler Automotive Aftermarket México S. de R.L. de C.V. se reserva todos y cada uno de los derechos sobre las fotografías exclusivas de la marca aquí presentadas; se prohíbe la reproducción parcial y/o total, uso, modificación y distribución de cada una de estas fotografías



BMC10364		BMC10365		BMC10366		BMC10367	
Referencia	Diámetro	Referencia	Diámetro	Referencia	Diámetro	Referencia	Diámetro
MC391081	37	MC391082	37	MC391085	23.8 - 15/16"	MC391092	23.8 - 15/16"
							
No. de puertos	Marca	No. de puertos	Marca	No. de puertos	Marca	No. de puertos	Marca
3	CHEVROLET	2	CHEVROLET, GMC	2	TOYOTA	2	VOLKSWAGEN



BMC10368		BMC10369		BMC10370		BMC10371	
Referencia	Diámetro	Referencia	Diámetro	Referencia	Diámetro	Referencia	Diámetro
MC391096	25.4 - 1"	MC391097	25.4 - 1"	MC391098	25.4 - 1"	MC391099	25.4 - 1"
							
No. de puertos	Marca	No. de puertos	Marca	No. de puertos	Marca	No. de puertos	Marca
3	NISSAN	4	NISSAN	4	NISSAN	2	NISSAN



BMC10372		BMC10373		BMC10374		BMC10375	
Referencia	Diámetro	Referencia	Diámetro	Referencia	Diámetro	Referencia	Diámetro
MC391100	22.2 - 7/8"	MC391101	20.6 - 13/16"	MC391110	30.1 - 1 3/16"	MC391121	31.7 - 1 1/4"
							
No. de puertos	Marca	No. de puertos	Marca	No. de puertos	Marca	No. de puertos	Marca
2	HONDA	2	HONDA	2	CHRYSLER, DODGE	2	DODGE



BMC10376		BMC10377		BMC10380		BMC10382	
Referencia	Diámetro	Referencia	Diámetro	Referencia	Diámetro	Referencia	Diámetro
MC391122	31.7 - 1 1/4"	MC391123	26.9 - 1 1/16"	MC391127	25.4 - 1"	MC391130	25.4 - 1"
							
No. de puertos	Marca	No. de puertos	Marca	No. de puertos	Marca	No. de puertos	Marca
2	CHRYSLER, DODGE	2	DODGE, JEEP	2	CHRYSLER, DODGE	2	VOLKSWAGEN

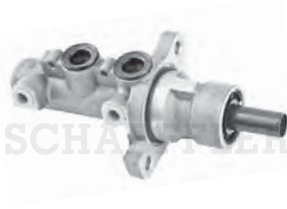



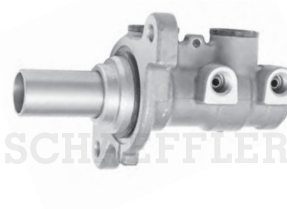

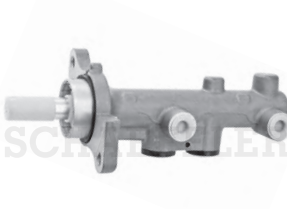
© Schaeffler Automotive Aftermarket México S. de R.L. de C.V. se reserva todos y cada uno de los derechos sobre las fotografías exclusivas de la marca aquí presentadas; se prohíbe la reproducción parcial y/o total, uso, modificación y distribución de cada una de estas fotografías

BMC10383		BMC10384		BMC10386		BMC10387	
Referencia	Diámetro	Referencia	Diámetro	Referencia	Diámetro	Referencia	Diámetro
MC391137	23.8 - 15/16"	MC391142	22.2 - 7/8"	MC391144	22.2 - 7/8"	MC391145	25.4 - 1"
							
No. de puertos	Marca	No. de puertos	Marca	No. de puertos	Marca	No. de puertos	Marca
2	FORD	2	DODGE	2	DODGE	2	CHEVROLET



BMC10388		BMC10389		BMC10390		BMC10391	
Referencia	Diámetro	Referencia	Diámetro	Referencia	Diámetro	Referencia	Diámetro
MC391147	26.9 - 1 1/16"	MC391150	28.5 - 1 1/8"	MC391156	23.8 - 15/16"	MC391158	25.4 - 1"
							
No. de puertos	Marca	No. de puertos	Marca	No. de puertos	Marca	No. de puertos	Marca
2	CHEVROLET, GMC	2	FORD	2	NISSAN	2	NISSAN





BMC10392		BMC10393		BMC10394		BMC10396	
Referencia	Diámetro	Referencia	Diámetro	Referencia	Diámetro	Referencia	Diámetro
MC391160	20.6 - 13/16"	MC391162	22.2 - 7/8"	MC391165	23.8 - 15/16"	MC391169	28.5 - 1 1/8"
							
No. de puertos	Marca	No. de puertos	Marca	No. de puertos	Marca	No. de puertos	Marca
2	FORD	2	FORD	2	CHEVROLET	2	CHEVROLET, CADILLAC



BMC10397		BMC10399		BMC10400		BMC10401	
Referencia	Diámetro	Referencia	Diámetro	Referencia	Diámetro	Referencia	Diámetro
MC391172	31.7 - 1 1/4"	MC391179	34	MC391180	37	MC391181	26.9 - 1 1/16"
							
No. de puertos	Marca	No. de puertos	Marca	No. de puertos	Marca	No. de puertos	Marca
2	CHEVROLET, CADILLAC	2	CHEVROLET, GMC	2	CHEVROLET, GMC	2	CHEVROLET, GMC





© Schaeffler Automotive Aftermarket México S. de R.L. de C.V. se reserva todos y cada uno de los derechos sobre las fotografías exclusivas de la marca aquí presentadas; se prohíbe la reproducción parcial y/o total, uso, modificación y distribución de cada una de estas fotografías

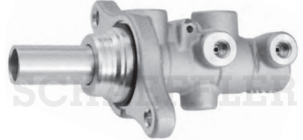

BMC10402		BMC10403		BMC10404		BMC10405	
Referencia	Diámetro	Referencia	Diámetro	Referencia	Diámetro	Referencia	Diámetro
MC391183	38.1 - 1 1/2"	MC391184	38.1 - 1 1/2"	MC391185	23.8 - 15/16"	MC391186	23.8 - 15/16"
							
No. de puertos	Marca	No. de puertos	Marca	No. de puertos	Marca	No. de puertos	Marca
3	CHEVROLET, GMC	2	CHEVROLET, GMC	2	CHEVROLET	2	CHEVROLET

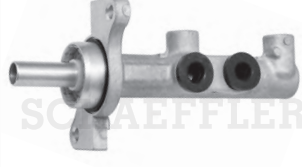
BMC10408		BMC10409		BMC10410		BMC10412	
Referencia	Diámetro	Referencia	Diámetro	Referencia	Diámetro	Referencia	Diámetro
MC391191	33.3 - 1 5/16"	MC391195	33.3 - 1 5/16"	MC391197	38.1 - 1 1/2"	MC391310	23.8 - 15/16"
							
No. de puertos	Marca	No. de puertos	Marca	No. de puertos	Marca	No. de puertos	Marca
3	FORD	2	FORD	2	FORD	2	NISSAN



BMC10413		BMC10414		BMC10415		BMC10416	
Referencia	Diámetro	Referencia	Diámetro	Referencia	Diámetro	Referencia	Diámetro
MC391200	38.1 - 1 1/2"	MC391203	26.9 - 1 1/16"	MC391204	26.9 - 1 1/16"	MC391207	22.2 - 7/8"
							
No. de puertos	Marca	No. de puertos	Marca	No. de puertos	Marca	No. de puertos	Marca
3	FORD	2	FORD	2	FORD, MERCURY	2	MAZDA

BMC10418		BMC10419		BMC10420		BMC10421	
Referencia	Diámetro	Referencia	Diámetro	Referencia	Diámetro	Referencia	Diámetro
MC391214	22.2 - 7/8"		20.6 - 13/16"	MC391307	23.8 - 15/16"	MC391225	25.4 - 1"
							
No. de puertos	Marca	No. de puertos	Marca	No. de puertos	Marca	No. de puertos	Marca
2	MAZDA	4	DODGE / HYUNDAI	2	NISSAN	2	HONDA



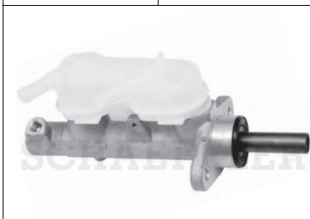
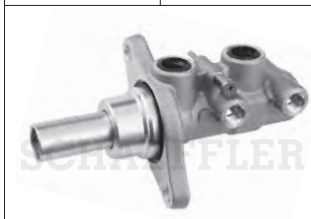
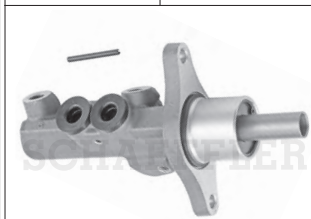
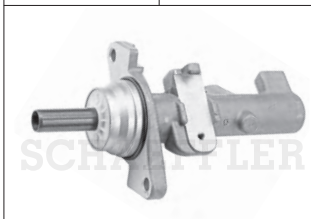

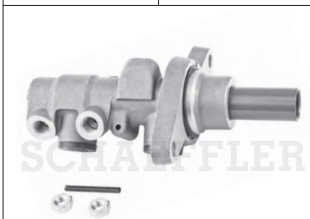
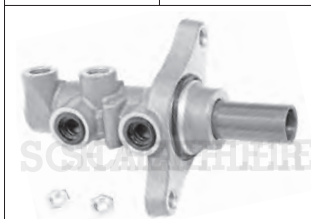
© Schaeffler Automotive Aftermarket México S. de R.L. de C.V. se reserva todos y cada uno de los derechos sobre las fotografías exclusivas de la marca aquí presentadas; se prohíbe la reproducción parcial y/o total, uso, modificación y distribución de cada una de estas fotografías

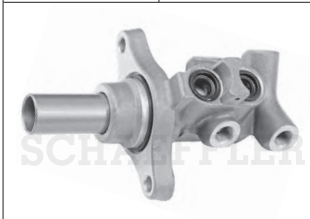
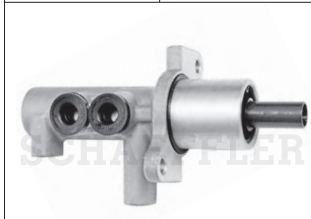
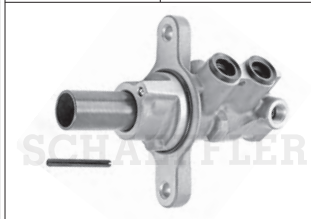
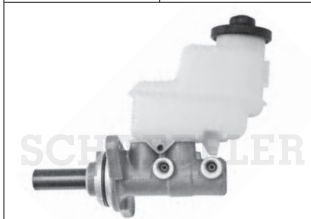

BMC10423		BMC10424		BMC10425		BMC10426	
Referencia	Diámetro	Referencia	Diámetro	Referencia	Diámetro	Referencia	Diámetro
MC391228	19.0 - 3/4"	MC391230	22.2 - 7/8"	MC391231	22.2 - 7/8"	MC391232	22.2 - 7/8"
							
No. de puertos	Marca	No. de puertos	Marca	No. de puertos	Marca	No. de puertos	Marca
2	HONDA	4	MAZDA	2	VOLKSWAGEN	2	AUDI





BMC10427		BMC10428		BMC10429		BMC10430	
Referencia	Diámetro	Referencia	Diámetro	Referencia	Diámetro	Referencia	Diámetro
MC391233	22.2 - 7/8"	MC391237	22.2 - 7/8"	MC391252	33.3 - 1 5/16"	MC391253	33.3 - 1 5/16"
							
No. de puertos	Marca	No. de puertos	Marca	No. de puertos	Marca	No. de puertos	Marca
2	VOLKSWAGEN	2	FORD, MERCURY	2	CHEVROLET, GMC	2	CHEVROLET, GMC





BMC10431		BMC10432		BMC10433		BMC10434	
Referencia	Diámetro	Referencia	Diámetro	Referencia	Diámetro	Referencia	Diámetro
MC391254	23.8 - 15/16"	MC391255	26.9 - 1 1/16"	MC391267	23.8 - 15/16"	MC391295	20.6 - 13/16"
							
No. de puertos	Marca	No. de puertos	Marca	No. de puertos	Marca	No. de puertos	Marca
2	FORD	3	FORD	2	NISSAN	2	TOYOTA





BMC10435		BMC10436		BMC10437		BMC10438	
Referencia	Diámetro	Referencia	Diámetro	Referencia	Diámetro	Referencia	Diámetro
MC391296	22.2 - 7/8"	MC391299	20.6 - 13/16"	MC391303	25.4 - 1"	MC391328	23.8 - 15/16"
							
No. de puertos	Marca	No. de puertos	Marca	No. de puertos	Marca	No. de puertos	Marca
2	TOYOTA	2	TOYOTA	2	NISSAN	2	CHEVROLET





© Schaeffler Automotive Aftermarket México S. de R.L. de C.V. se reserva todos y cada uno de los derechos sobre las fotografías exclusivas de la marca aquí presentadas; se prohíbe la reproducción parcial y/o total, uso, modificación y distribución de cada una de estas fotografías

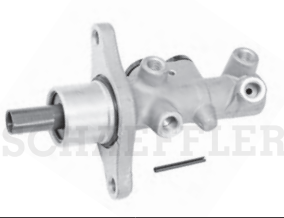

BMC10439		BMC10440		BMC10441		BMC10442	
Referencia	Diámetro	Referencia	Diámetro	Referencia	Diámetro	Referencia	Diámetro
MC391329	23.8 - 15/16"	MC391331	22.2 - 7/8"	MC391332	22.2 - 7/8"	MC391333	22.2 - 7/8"
							
No. de puertos	Marca	No. de puertos	Marca	No. de puertos	Marca	No. de puertos	Marca
2	CHEVROLET	2	CHEVROLET	2	CHEVROLET	2	CHEVROLET





BMC10443		BMC10444		BMC10445		BMC10446	
Referencia	Diámetro	Referencia	Diámetro	Referencia	Diámetro	Referencia	Diámetro
MC391341	25.4 - 1"	MC391343	25.4 - 1"	MC391344	25.4 - 1"	MC391359	30.1 - 1 3/16"
							
No. de puertos	Marca	No. de puertos	Marca	No. de puertos	Marca	No. de puertos	Marca
2	NISSAN	2	NISSAN	2	MITSUBISHI	2	FORD





BMC10447		BMC10448		BMC10449		BMC10451	
Referencia	Diámetro	Referencia	Diámetro	Referencia	Diámetro	Referencia	Diámetro
MC391376	20.6 - 13/16"	MC391378	22.2 - 7/8"	MC391384	23.8 - 15/16"	MC39147	20.6 - 13/16"
							
No. de puertos	Marca	No. de puertos	Marca	No. de puertos	Marca	No. de puertos	Marca
2	TOYOTA	2	HONDA	4	AUDI, SEAT	6	VOLKSWAGEN

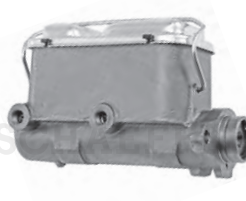

BMC10452		BMC10453		BMC10454		BMC10455	
Referencia	Diámetro	Referencia	Diámetro	Referencia	Diámetro	Referencia	Diámetro
MC39173	26.9 - 1 1/16"	MC39178	28.5 - 1 1/8"	MC39223	28.5 & 40.0	MC39324	31.7 - 1 1/4"
							
No. de puertos	Marca	No. de puertos	Marca	No. de puertos	Marca	No. de puertos	Marca
2	FORD	2	DODGE	2	CHEVROLET	2	CHEVROLET



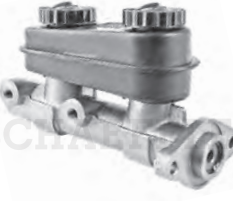

© Schaeffler Automotive Aftermarket México S. de R.L. de C.V. se reserva todos y cada uno de los derechos sobre las fotografías exclusivas de la marca aquí presentadas; se prohíbe la reproducción parcial y/o total, uso, modificación y distribución de cada una de estas fotografías

BMC10457		BMC10460		BMC10462		BMC10463	
Referencia	Diámetro	Referencia	Diámetro	Referencia	Diámetro	Referencia	Diámetro
MC39350	21.0 - 53/64"	MC39382	22.2 - 7/8"	MC39435	33.3 - 1 5/16"	MC39443	19,8
							
No. de puertos	Marca	No. de puertos	Marca	No. de puertos	Marca	No. de puertos	Marca
2	FORD	4	CHEVROLET	2	CHEVROLET	4	FORD

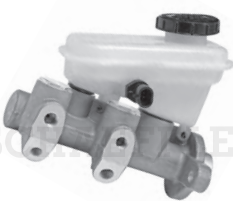



BMC10464		BMC10465		BMC10467		BMC10469	
Referencia	Diámetro	Referencia	Diámetro	Referencia	Diámetro	Referencia	Diámetro
MC39445	28.5 - 1 1/8"	MC39451	21.0 - 53/64"	MC39476	24	MC39531	21.0 - 53/64"
							
No. de puertos	Marca	No. de puertos	Marca	No. de puertos	Marca	No. de puertos	Marca
2	FORD	2	CHRYSLER	2	CHRYSLER	2	FORD





BMC10470		BMC10471		BMC10472		BMC10473	
Referencia	Diámetro	Referencia	Diámetro	Referencia	Diámetro	Referencia	Diámetro
MC39555	19.0 - 3/4"	MC39567	23.8 - 15/16"	MC39571	24.0 & 36.0	MC39583	22.2 - 7/8"
							
No. de puertos	Marca	No. de puertos	Marca	No. de puertos	Marca	No. de puertos	Marca
2	NISSAN	2	FORD	2	CHEVROLET, GMC	4	CHEVROLET, BUICK

BMC10474		BMC10475		BMC10476		BMC10477	
Referencia	Diámetro	Referencia	Diámetro	Referencia	Diámetro	Referencia	Diámetro
MC39585	24	MC39589	25.4 & 36.0	MC39593	25.4 - 1"	MC39628	23.8 - 15/16"
							
No. de puertos	Marca	No. de puertos	Marca	No. de puertos	Marca	No. de puertos	Marca
4	CHEVROLET, BUICK	2	CHEVROLET	2	NISSAN	2	FORD



© Schaeffler Automotive Aftermarket México S. de R.L. de C.V. se reserva todos y cada uno de los derechos sobre las fotografías exclusivas de la marca aquí presentadas; se prohíbe la reproducción parcial y/o total, uso, modificación y distribución de cada una de estas fotografías

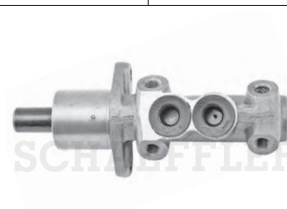

BMC10478		BMC10479		BMC10480		BMC10481	
Referencia	Diámetro	Referencia	Diámetro	Referencia	Diámetro	Referencia	Diámetro
MC39634	26.9 - 1 1/16"	MC39635	28.5 - 1 1/8"	MC39636	28.5 - 1 1/8"	MC39637	21.0 & 30.2
							
No. de puertos	Marca	No. de puertos	Marca	No. de puertos	Marca	No. de puertos	Marca
2	FORD	2	FORD	2	FORD	3	FORD



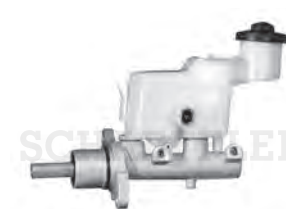

BMC10482		BMC10483		BMC10484		BMC10485	
Referencia	Diámetro	Referencia	Diámetro	Referencia	Diámetro	Referencia	Diámetro
MC39646	28.5 - 1 1/8"	MC39649	31.7 - 1 1/4"	MC39655	20.6 - 13/16"	MC39712	28.5 - 1 1/8"
							
No. de puertos	Marca	No. de puertos	Marca	No. de puertos	Marca	No. de puertos	Marca
2	CHEVROLET	2	CHEVROLET	4	VOLKSWAGEN	2	DODGE





BMC10487		BMC10488		BMC10489		BMC10490	
Referencia	Diámetro	Referencia	Diámetro	Referencia	Diámetro	Referencia	Diámetro
MC39780	20.6 - 13/16"	46010F40	23.8 - 15/16"	MC39953	25.4 - 1"	MC39958	25.4 - 1"
							
No. de puertos	Marca	No. de puertos	Marca	No. de puertos	Marca	No. de puertos	Marca
2	HONDA	2	NISSAN	2	FORD, MAZDA	4	FORD





BMC10491		BMC10492		BMC10493		BMC10494	
Referencia	Diámetro	Referencia	Diámetro	Referencia	Diámetro	Referencia	Diámetro
MC39981	23.8 - 15/16"	MIS55214	22.2 - 7/8"	39009906	22.2 - 7/8"	47201 09210	20.6 - 13/16"
							
No. de puertos	Marca	No. de puertos	Marca	No. de puertos	Marca	No. de puertos	Marca
2	JEEP	3	FORD	4	FORD	2	TOYOTA







© Schaeffler Automotive Aftermarket México S. de R.L. de C.V. se reserva todos y cada uno de los derechos sobre las fotografías exclusivas de la marca aquí presentadas; se prohíbe la reproducción parcial y/o total, uso, modificación y distribución de cada una de estas fotografías

BMC10495		BMC10496		BMC10497		BMC10498	
Referencia	Diámetro	Referencia	Diámetro	Referencia	Diámetro	Referencia	Diámetro
4601004C00	23.8 - 15/16"	MN102440	23.8 - 15/16"	39009907	22.2 - 7/8"	39009915	25.4 - 1"
							
No. de puertos	Marca	No. de puertos	Marca	No. de puertos	Marca	No. de puertos	Marca
2	NISSAN	2	MITSUBISHI	2	CHEVROLET	2	NISSAN

BMC10499		BMC10500		BMC10501		BMC10502	
Referencia	Diámetro	Referencia	Diámetro	Referencia	Diámetro	Referencia	Diámetro
6C2Z2140AA	31.7 - 1 1/4"	MC391170	22.2 - 7/8"	MC390183	26.9 - 1 1/16"	MC391133	26.9 - 1 1/16"
							
No. de puertos	Marca	No. de puertos	Marca	No. de puertos	Marca	No. de puertos	Marca
2	FORD	2	CHEVROLET	3	FORD	2	FORD

BMC10503		BMC10504		BMC10505		BMC10506	
Referencia	Diámetro	Referencia	Diámetro	Referencia	Diámetro	Referencia	Diámetro
39009914	20.6 - 13/16"	39009900	23.8 - 15/16"	39009909	20.6 - 13/16"	6809 3470 AA	22.2 - 7/8"
							
No. de puertos	Marca	No. de puertos	Marca	No. de puertos	Marca	No. de puertos	Marca
2	CHEVROLET	2	HYUNDAI	2	TOYOTA	4	FIAT, RAM

BMC10509		BMC10510		BMC10511		BMC10512	
Referencia	Diámetro	Referencia	Diámetro	Referencia	Diámetro	Referencia	Diámetro
96418852	23.8 - 15/16"	59110 4F000	26.9 - 1 1/16"	010733	22.2 - 7/8"	MC390781	25.4 - 1"
							
No. de puertos	Marca	No. de puertos	Marca	No. de puertos	Marca	No. de puertos	Marca
2	CHEVROLET	2	HYUNDAI	4	FORD	2	MITSUBISHI

© Schaeffler Automotive Aftermarket México S. de R.L. de C.V. se reserva todos y cada uno de los derechos sobre las fotografías exclusivas de la marca aquí presentadas; se prohíbe la reproducción parcial y/o total, uso, modificación y distribución de cada una de estas fotografías



BMC10513		BMC10514		BMC10515		BMC10516	
Referencia	Diámetro	Referencia	Diámetro	Referencia	Diámetro	Referencia	Diámetro
MN102441	23.8 - 15/16"	95984181	23.8 - 15/16"	51100 54G60	22.2 - 7/8"	010779	23.8 - 15/16"
No. de puertos	Marca	No. de puertos	Marca	No. de puertos	Marca	No. de puertos	Marca
2	MITSUBISHI	2	CHEVROLET	2	SUZUKI	2	RENAULT



BMC10517		BMC10518		BMC10519		BMC10521	
Referencia	Diámetro	Referencia	Diámetro	Referencia	Diámetro	Referencia	Diámetro
47201 0K010	20.6 - 13/16"	47201 09060	20.6 - 13/16"	BE8Z-2140-A	20.6 - 13/16"	7L5Z-2140-AA	26.9 - 1 1/16"
No. de puertos	Marca	No. de puertos	Marca	No. de puertos	Marca	No. de puertos	Marca
2	TOYOTA	2	TOYOTA	2	FORD	2	FORD



BMC10522		BMC10523		BMC10526		BMC10527	
Referencia	Diámetro	Referencia	Diámetro	Referencia	Diámetro	Referencia	Diámetro
MC390792	23.8 - 15/16"	509 3407 AB	33.3 - 1 5/16"	46100-TF0-Y01	19.0 - 3/4"	MC391138	22.2 - 7/8"
No. de puertos	Marca	No. de puertos	Marca	No. de puertos	Marca	No. de puertos	Marca
2	HONDA	2	RAM	2	HONDA	2	TOYOTA

BMC10528		BMC10529		BMC10530		BMC10531	
Referencia	Diámetro	Referencia	Diámetro	Referencia	Diámetro	Referencia	Diámetro
390911RL	20.6 - 13/16"	39009913	23.8 - 15/16"	MC391271	23.8 - 15/16"	46101 TK8 305	22.2 - 7/8"
No. de puertos	Marca	No. de puertos	Marca	No. de puertos	Marca	No. de puertos	Marca
4	SEAT	2	NISSAN	2	DODGE	2	HONDA

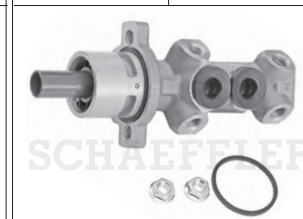



© Schaeffler Automotive Aftermarket México S. de R.L. de C.V. se reserva todos y cada uno de los derechos sobre las fotografías exclusivas de la marca aquí presentadas; se prohíbe la reproducción parcial y/o total, uso, modificación y distribución de cada una de estas fotografías

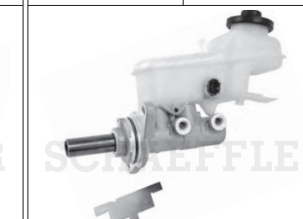

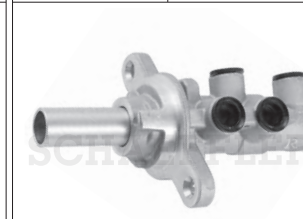
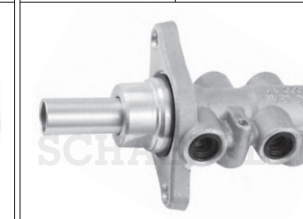
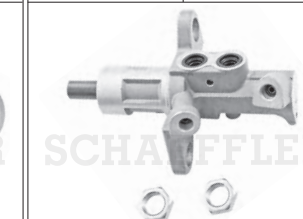
BMC10532		BMC10533		BMC10534		BMC10535	
Referencia	Diámetro	Referencia	Diámetro	Referencia	Diámetro	Referencia	Diámetro
MC391358	23.8 - 15/16"	77 01 205 407	22.2 - 7/8"	MC391403	23.8 - 15/16"	MC390696	26.9 - 1 1/16"
							
No. de puertos	Marca	No. de puertos	Marca	No. de puertos	Marca	No. de puertos	Marca
2	CHEVROLET	4	RENAULT	2	NISSAN	2	FORD



BMC10536		BMC10537		BMC10538		BMC10539	
Referencia	Diámetro	Referencia	Diámetro	Referencia	Diámetro	Referencia	Diámetro
MC390418	25.4 - 1"	MC390783	15.8 - 5/8"	MC390760	22.2 - 7/8"	MC391219	20.6 - 13/16"
							
No. de puertos	Marca	No. de puertos	Marca	No. de puertos	Marca	No. de puertos	Marca
2	HONDA	2	HONDA	4	MITSUBISHI	2	TOYOTA



BMC10540		BMC10541		BMC10542		BMC10543	
Referencia	Diámetro	Referencia	Diámetro	Referencia	Diámetro	Referencia	Diámetro
47201-BZ570	22.2 - 7/8"	EG23 4340 Z	22.2 - 7/8"	4625 A199	20.6 - 13/16"	13286445	25.4 - 1"
							
No. de puertos	Marca	No. de puertos	Marca	No. de puertos	Marca	No. de puertos	Marca
2	TOYOTA	2	MAZDA	2	MITSUBISHI	2	BUICK, CHEVROLET



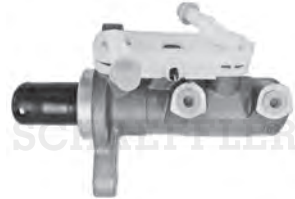

BMC10544		BMC10545		BMC10546		BMC10547	
Referencia	Diámetro	Referencia	Diámetro	Referencia	Diámetro	Referencia	Diámetro
BL3Z 2140 A	30.1 - 1 3/16"	MC391387	25.4 - 1"	456 0183 AA	26.9 - 1 1/16"	2E0 611 017 E	27.0 - 1 1/16"
							
No. de puertos	Marca	No. de puertos	Marca	No. de puertos	Marca	No. de puertos	Marca
2	FORD, LINCOLN	2	FORD	2	DODGE, JEEP	1	MB - VW



© Schaeffler Automotive Aftermarket México S. de R.L. de C.V. se reserva todos y cada uno de los derechos sobre las fotografías exclusivas de la marca aquí presentadas; se prohíbe la reproducción parcial y/o total, uso, modificación y distribución de cada una de estas fotografías



BMC10548		BMC10549		BMC10550		BMC10552	
Referencia	Diámetro	Referencia	Diámetro	Referencia	Diámetro	Referencia	Diámetro
6Q0 611 019 E	20.6 - 13/16"	2H0 611 019	26.9 - 1 1/16"	MC391103	25.4 - 1"		26.9 - 1 1/16"
							
No. de puertos	Marca	No. de puertos	Marca	No. de puertos	Marca	No. de puertos	Marca
4	VOLKSWAGEN	2	VOLKSWAGEN	2	CHRYSLER, VW	2	NISSAN





BMC10553		BMC10560		BMC10561		BMC10562	
Referencia	Diámetro	Referencia	Diámetro	Referencia	Diámetro	Referencia	Diámetro
58510-1R000	20.6 - 13/16"	CK4Z 2140 A	28.5 - 1 1/8"	46010-VK94B	23.8 - 15/16"	D6010-3XT0A	25.4 - 1"
							
No. de puertos	Marca	No. de puertos	Marca	No. de puertos	Marca	No. de puertos	Marca
4	DODGE	2	FORD	3	NISSAN	2	NISSAN





BMC10563		BMC10564		BMC10565		BMC10566	
Referencia	Diámetro	Referencia	Diámetro	Referencia	Diámetro	Referencia	Diámetro
58510 1R100	20.6 - 13/16"	94566232	20.63 - 13/16"	58510-4H000	27.0 - 1 1/16"	1819085	22.2 - 7/8"
							
No. de puertos	Marca	No. de puertos	Marca	No. de puertos	Marca	No. de puertos	Marca
2	DODGE	2	CHEVROLET	4	DODGE	2	FORD





BMC10567		BMC10568		BMC10569		BMC10570	
Referencia	Diámetro	Referencia	Diámetro	Referencia	Diámetro	Referencia	Diámetro
20925765	33.3 - 1 5/16"	6815 5423 AC	27.0 - 1 1/16"	94766502	22.2 - 7/8"	46010-00Q0J	20.6 - 13/16"
							
No. de puertos	Marca	No. de puertos	Marca	No. de puertos	Marca	No. de puertos	Marca
2	CHEVROLET	2	DODGE	4	CHEVROLET	4	NISSAN







© Schaeffler Automotive Aftermarket México S. de R.L. de C.V. se reserva todos y cada uno de los derechos sobre las fotografías exclusivas de la marca aquí presentadas; se prohíbe la reproducción parcial y/o total, uso, modificación y distribución de cada una de estas fotografías

BMC10571		BMC10572		BMC10573		BMC10574	
Referencia	Diámetro	Referencia	Diámetro	Referencia	Diámetro	Referencia	Diámetro
6R1 611 019 A	22.2 - 7/8"	94769766	22.2 - 7/8"	CS69 2140 AA	23.8 - 15/16"	MC391474	23.8 - 15/16"
							
No. de puertos	Marca	No. de puertos	Marca	No. de puertos	Marca	No. de puertos	Marca
2	AUDI - VW - SEAT	2	CHEVROLET	4	FORD	2	NISSAN





BMC10575		BMC10576		BMC10579		BMC10580	
Referencia	Diámetro	Referencia	Diámetro	Referencia	Diámetro	Referencia	Diámetro
MC391477	23.8 - 15/16"	97148431	25.4 - 1"	4625 A437	19.1 - 3/4"	MC391526	23.8 - 15/16"
							
No. de puertos	Marca	No. de puertos	Marca	No. de puertos	Marca	No. de puertos	Marca
2	NISSAN	2	CHEVROLET	2	MITSUBISHI, DODGE	2	CHEVROLET, BUICK

BMC10581		BMC10583		BMC10584		BMC10587	
Referencia	Diámetro	Referencia	Diámetro	Referencia	Diámetro	Referencia	Diámetro
93182937	25.4 - 1"	95393156	22.2 - 7/8"	2S71-2B507-AC	23.8 - 15/16"	MC391462	20.6 - 13/16"
							
No. de puertos	Marca	No. de puertos	Marca	No. de puertos	Marca	No. de puertos	Marca
2	CHEVROLET	4	CHEVROLET	2	FORD	2	ACURA - HONDA

BMC10601		BMC10603		BMC10604		BMC10605	
Referencia	Diámetro	Referencia	Diámetro	Referencia	Diámetro	Referencia	Diámetro
46010-4KH5B	25.4 - 1"	47201-BZ550	22.0 & 33.0	47201-0K040	20.6 - 13/16"	MC390550	23.8 - 15/16"
							
No. de puertos	Marca	No. de puertos	Marca	No. de puertos	Marca	No. de puertos	Marca
2	NISSAN	2	TOYOTA	2	TOYOTA	2	HONDA

© Schaeffler Automotive Aftermarket México S. de R.L. de C.V. se reserva todos y cada uno de los derechos sobre las fotografías exclusivas de la marca aquí presentadas; se prohíbe la reproducción parcial y/o total, uso, modificación y distribución de cada una de estas fotografías



BMC10607		BMC10609		BMC10610		BMC10611	
Referencia	Diámetro	Referencia	Diámetro	Referencia	Diámetro	Referencia	Diámetro
51100-65JB0	23.8 - 15/16"	5Z0 611 019 H	20.6 - 13/16"	46100-TOG-A02	22.2 - 7/8"	47201-0K410	22.2 - 7/8"
							
No. de puertos	Marca	No. de puertos	Marca	No. de puertos	Marca	No. de puertos	Marca
2	SUZUKI	4	VOLKSWAGEN	2	HONDA	2	TOYOTA

BMC10612		BMC10614		BMC10615	
Referencia	Diámetro	Referencia	Diámetro	Referencia	Diámetro
4601.V8	23.8 - 15/16"	60 01 551 313	20.6 - 13/16"	6R1 611 019 F	22.2 - 7/8"
					
No. de puertos	Marca	No. de puertos	Marca	No. de puertos	Marca
2	PEUGEOT	4	RENAULT, NISSAN	2	AUDI,VW,SEAT



BRILLANTE

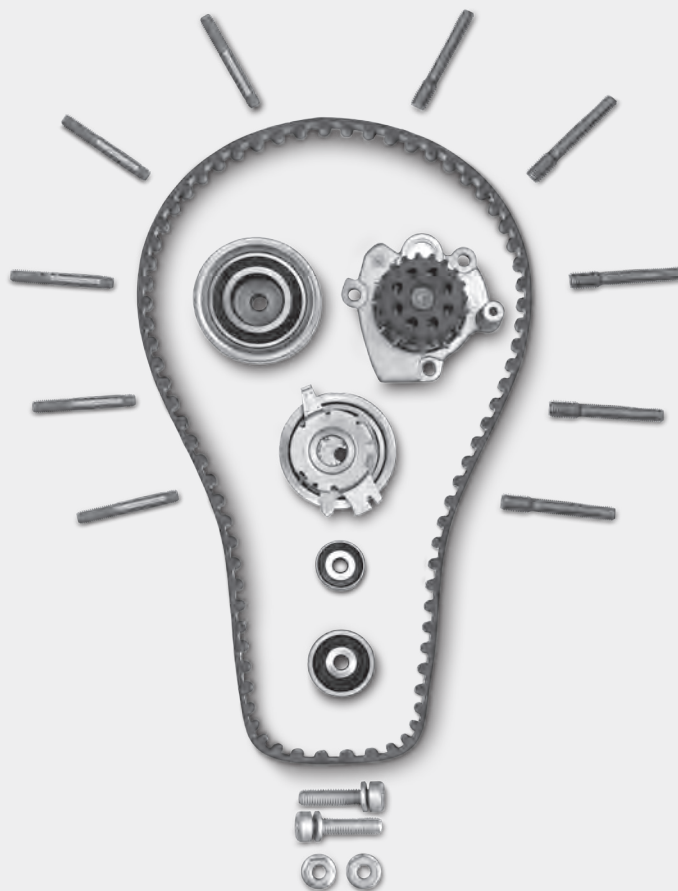

Kits de banda de distribución de INA

Nuestros Kits de banda de distribución son la primera opción para el mantenimiento regular en sistema de distribución, debido que contienen todos los componentes necesarios para realizar la reparación.

INA ofrece soluciones especialmente desarrolladas para cada vehículo con la opción de tener incluida la bomba de agua.



REXPERT.MX
Servicio Técnico: 800 8000 585
Lun - Vier 9:00 a 18:00
servicio.tecnico@schaeffler.com
info@rexpert.mx
www.rexpert.mx
www.schaeffler.mx

SCHAEFFLER



WBC50101		WBC50102		WBC50103		WBC50104	
Referencia	Diámetro	Referencia	Diámetro	Referencia	Diámetro	Referencia	Diámetro
844	19.0 - 3/4"	WC37855	23.8 - 15/16"	WC37870	20.6 - 13/16"	LC117345	19.0 - 3/4"
Posición	Marca	Posición	Marca	Posición	Marca	Posición	Marca
	CHEVROLET		BUICK, CADILLAC		NISSAN		NISSAN





WBC50105		WBC50106		WBC50107		WBC50108	
Referencia	Diámetro	Referencia	Diámetro	Referencia	Diámetro	Referencia	Diámetro
WC370138	17.8 - 45/64"	370382	22.2 - 7/8"	370384	22.2 - 7/8"	37090426MX	17.8 - 45/64"
Posición	Marca	Posición	Marca	Posición	Marca	Posición	Marca
	DODGE	DERECHO	CHEVROLET	IZQUIERDO	CHEVROLET		FORD





WBC50109		WBC50110		WBC50111		WBC50112	
Referencia	Diámetro	Referencia	Diámetro	Referencia	Diámetro	Referencia	Diámetro
3700900	19.0 - 3/4"	3700904	22.2 - 7/8"	3700908	19.0 - 3/4"	3700912	22.2 - 7/8"
Posición	Marca	Posición	Marca	Posición	Marca	Posición	Marca
	FORD		FORD		FIAT		RENAULT

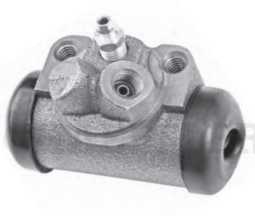



WBC50113		WBC50114		WBC50115		WBC50116	
Referencia	Diámetro	Referencia	Diámetro	Referencia	Diámetro	Referencia	Diámetro
3700913	22.2 - 7/8"	3700914	17.4 - 11/16"	37009016	22.2 - 7/8"	37009017	22.2 - 7/8"
Posición	Marca	Posición	Marca	Posición	Marca	Posición	Marca
	PEUGEOT		CHEVROLET	DERECHO	HYUNDAI	IZQUIERDO	HYUNDAI



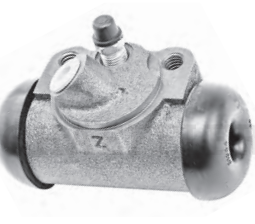

© Schaeffler Automotive Aftermarket México S. de R.L. de C.V. se reserva todos y cada uno de los derechos sobre las fotografías exclusivas de la marca aquí presentadas; se prohíbe la reproducción parcial y/o total, uso, modificación y distribución de cada una de estas fotografías



WBC50121		WBC50122		WBC50123		WBC50124	
Referencia	Diámetro	Referencia	Diámetro	Referencia	Diámetro	Referencia	Diámetro
4410000Q	17.8 - 45/64"	WC13387	25.4 - 1"	WC13388	25.4 - 1"	WC17507	22.2 - 7/8"
							
Posición	Marca	Posición	Marca	Posición	Marca	Posición	Marca
	NISSAN	IZQUIERDO	CHEVROLET	DERECHO	CHEVROLET	IZQUIERDO	DODGE

WBC50125		WBC50126		WBC50127		WBC50130	
Referencia	Diámetro	Referencia	Diámetro	Referencia	Diámetro	Referencia	Diámetro
WC17508	22.2 - 7/8"	WC370192	23.8 - 15/16"	WC370193	23.8 - 15/16"	WC34876	20.6 - 13/16"
							
Posición	Marca	Posición	Marca	Posición	Marca	Posición	Marca
DERECHO	DODGE	IZQUIERDO	FORD	DERECHO	FORD		CHRYSLER, DODGE, FORD

WBC50133		WBC50134		WBC50135		WBC50136	
Referencia	Diámetro	Referencia	Diámetro	Referencia	Diámetro	Referencia	Diámetro
WC36057	28.5 - 1 1/8"	WC36058	28.5 - 1 1/8"	WC36076	20.6 - 13/16"	WC36077	20.6 - 13/16"
							
Posición	Marca	Posición	Marca	Posición	Marca	Posición	Marca
IZQUIERDO	CHEVROLET, DODGE	DERECHO	CHEVROLET, DODGE	IZQUIERDO	FORD	DERECHO	FORD

WBC50137		WBC50138		WBC50139		WBC50140	
Referencia	Diámetro	Referencia	Diámetro	Referencia	Diámetro	Referencia	Diámetro
WC370027	19.0 - 3/4"	WC370031	19.0 - 3/4"	WC370032	23.8 - 15/16"	WC370042	28.5 - 1 1/8"
							
Posición	Marca	Posición	Marca	Posición	Marca	Posición	Marca
	CHRYSLER		FORD, MAZDA		TOYOTA	IZQUIERDO	FORD

© Schaeffler Automotive Aftermarket México S. de R.L. de C.V. se reserva todos y cada uno de los derechos sobre las fotografías exclusivas de la marca aquí presentadas; se prohíbe la reproducción parcial y/o total, uso, modificación y distribución de cada una de estas fotografías



WBC50141		WBC50142		WBC50143		WBC50144	
Referencia	Diámetro	Referencia	Diámetro	Referencia	Diámetro	Referencia	Diámetro
WC370043	28.5 - 1 1/8"	WC370191	20.6 - 13/16"	WC370055	22.2 - 7/8"	WC370060	22.2 - 7/8"
Posición	Marca	Posición	Marca	Posición	Marca	Posición	Marca
DERECHO	FORD		BUICK		CHEVROLET		NISSAN

WBC50145		WBC50146		WBC50147		WBC50148	
Referencia	Diámetro	Referencia	Diámetro	Referencia	Diámetro	Referencia	Diámetro
WC370061	20.6 - 13/16"	WC370073	22.2 - 7/8"	WC370074	22.2 - 7/8"	WC370081	17.4 - 11/16"
Posición	Marca	Posición	Marca	Posición	Marca	Posición	Marca
	FORD, MAZDA	IZQUIERDO	CHEVROLET	DERECHO	CHEVROLET		DODGE

WBC50149		WBC50150		WBC50151		WBC50152	
Referencia	Diámetro	Referencia	Diámetro	Referencia	Diámetro	Referencia	Diámetro
WC370083	25.4 - 1"	WC370087	22.2 - 7/8"	WC370088	22.2 - 7/8"	WC370091	22.2 - 7/8"
Posición	Marca	Posición	Marca	Posición	Marca	Posición	Marca
	MERCURY	DERECHO	HONDA	IZQUIERDO	HONDA	IZQUIERDO	FORD

WBC50153		WBC50154		WBC50155		WBC50156	
Referencia	Diámetro	Referencia	Diámetro	Referencia	Diámetro	Referencia	Diámetro
WC370092	22.2 - 7/8"	WC370093	20.6 - 13/16"	WC370094	23.8 - 15/16"	WC370095	22.2 - 7/8"
Posición	Marca	Posición	Marca	Posición	Marca	Posición	Marca
DERECHO	FORD		FORD		FORD, MERCURY, MAZDA	DERECHO	CHEVROLET

© Schaeffler Automotive Aftermarket México S. de R.L. de C.V. se reserva todos y cada uno de los derechos sobre las fotografías exclusivas de la marca aquí presentadas; se prohíbe la reproducción parcial y/o total, uso, modificación y distribución de cada una de estas fotografías



WBC50157		WBC50158		WBC50159		WBC50160	
Referencia	Diámetro	Referencia	Diámetro	Referencia	Diámetro	Referencia	Diámetro
WC370096	22.2 - 7/8"	WC370105	20.6 - 13/16"	WC370106	19.0 - 3/4"	WC370109	19.0 - 3/4"
Posición	Marca	Posición	Marca	Posición	Marca	Posición	Marca
IZQUIERDO	CHEVROLET		JEEP		NISSAN		DODGE

WBC50162		WBC50163		WBC50165		WBC50166	
Referencia	Diámetro	Referencia	Diámetro	Referencia	Diámetro	Referencia	Diámetro
WC370112	19.0 - 3/4"		17.4 - 11/16"	WC370123	20.6 - 13/16"	WC370127	20.6 - 13/16"
Posición	Marca	Posición	Marca	Posición	Marca	Posición	Marca
	TOYOTA		VOLKSWAGEN	IZQUIERDO	HONDA	DERECHO	HONDA

WBC50167		WBC50168		WBC50169		WBC50170	
Referencia	Diámetro	Referencia	Diámetro	Referencia	Diámetro	Referencia	Diámetro
WC370129	20.6 - 13/16"	WC370130	22.2 - 7/8"	WC370131	19.0 - 3/4"	WC370132	19.0 - 3/4"
Posición	Marca	Posición	Marca	Posición	Marca	Posición	Marca
	MITSUBISHI		PONTIAC	IZQUIERDO	HONDA	DERECHO	HONDA

WBC50172		WBC50173		WBC50174		WBC50175	
Referencia	Diámetro	Referencia	Diámetro	Referencia	Diámetro	Referencia	Diámetro
WC370139	19.0 - 3/4"	WC370141	17.4 - 11/16"	WC370142	15.8 - 5/8"	WC370143	22.2 - 7/8"
Posición	Marca	Posición	Marca	Posición	Marca	Posición	Marca
IZQUIERDO	TOYOTA		NISSAN		NISSAN		TOYOTA

© Schaeffler Automotive Aftermarket México S. de R.L. de C.V. se reserva todos y cada uno de los derechos sobre las fotografías exclusivas de la marca aquí presentadas; se prohíbe la reproducción parcial y/o total, uso, modificación y distribución de cada una de estas fotografías



WBC50176		WBC50177		WBC50178		WBC50179	
Referencia	Diámetro	Referencia	Diámetro	Referencia	Diámetro	Referencia	Diámetro
WC370146	19.0 - 3/4"	WC370148	23.8 - 15/16"	WC370149	19.0 - 3/4"	WC370152	19.0 - 3/4"
Posición	Marca	Posición	Marca	Posición	Marca	Posición	Marca
DERECHO	TOYOTA		CHEVROLET, GMC	IZQUIERDO	HONDA	DERECHO	HONDA

WBC50180		WBC50181		WBC50182		WBC50185	
Referencia	Diámetro	Referencia	Diámetro	Referencia	Diámetro	Referencia	Diámetro
WC370060	22.2 - 7/8"	WC370155	19.0 - 3/4"	WC370157	15.8 - 5/8"	WC370177	26.9 - 1 1/16"
Posición	Marca	Posición	Marca	Posición	Marca	Posición	Marca
	NISSAN		NISSAN		NISSAN		DODGE

WBC50186		WBC50187		WBC50188		WBC50189	
Referencia	Diámetro	Referencia	Diámetro	Referencia	Diámetro	Referencia	Diámetro
WC370180	23.8 - 15/16"	WC370181	26.9 - 1 1/16"	WC370182	19.0 - 3/4"	WC370183	23.8 - 15/16"
Posición	Marca	Posición	Marca	Posición	Marca	Posición	Marca
	CHEVROLET, GMC		CHEVROLET, GMC		HONDA		TOYOTA

WBC50190		WBC50191		WBC50192		WBC50193	
Referencia	Diámetro	Referencia	Diámetro	Referencia	Diámetro	Referencia	Diámetro
WC370185	19.0 - 3/4"	WC370186	20.6 - 13/16"	WC370187	22.2 - 7/8"	WC370189	30.1 - 1 3/16"
Posición	Marca	Posición	Marca	Posición	Marca	Posición	Marca
	FORD		CHEVROLET		CHEVROLET		CHEVROLET

© Schaeffler Automotive Aftermarket México S. de R.L. de C.V. se reserva todos y cada uno de los derechos sobre las fotografías exclusivas de la marca aquí presentadas; se prohíbe la reproducción parcial y/o total, uso, modificación y distribución de cada una de estas fotografías



WBC50194		WBC50195		WBC50196		WBC50197	
Referencia	Diámetro	Referencia	Diámetro	Referencia	Diámetro	Referencia	Diámetro
WC370190	23.8 - 15/16"	WC370194	17.4 - 11/16"	WC370195	19.0 - 3/4"	WC370197	20.6 - 13/16"
Posición	Marca	Posición	Marca	Posición	Marca	Posición	Marca
	CHEVROLET		DODGE		CHRYSLER		DODGE

WBC50198		WBC50199		WBC50200		WBC50201	
Referencia	Diámetro	Referencia	Diámetro	Referencia	Diámetro	Referencia	Diámetro
WC370200	26.9 - 1 1/16"	WC370201	23.8 - 15/16"	WC370205	17.4 - 11/16"	WC370206	17.4 - 11/16"
Posición	Marca	Posición	Marca	Posición	Marca	Posición	Marca
	CHEVROLET, GMC		CHEVROLET, GMC	IZQUIERDO	HONDA	DERECHO	HONDA

WBC50202		WBC50203		WBC50204		WBC50205	
Referencia	Diámetro	Referencia	Diámetro	Referencia	Diámetro	Referencia	Diámetro
WC370211	23.8 - 15/16"	WC370212	19.0 - 3/4"	WC370213	17.4 - 11/16"	WC370214	15.8 - 5/8"
Posición	Marca	Posición	Marca	Posición	Marca	Posición	Marca
	FORD		NISSAN		NISSAN		NISSAN

WBC50206		WBC50207		WBC50208		WBC50209	
Referencia	Diámetro	Referencia	Diámetro	Referencia	Diámetro	Referencia	Diámetro
WC370225	19.0 - 3/4"	WC370226	20.6 - 13/16"	WC37048	23.8 - 15/16"	WC37080	25.4 - 1"
Posición	Marca	Posición	Marca	Posición	Marca	Posición	Marca
	FORD		CHEVROLET		CHEVROLET		CHEVROLET, CADILLAC

© Schaeffler Automotive Aftermarket México S. de R.L. de C.V. se reserva todos y cada uno de los derechos sobre las fotografías exclusivas de la marca aquí presentadas; se prohíbe la reproducción parcial y/o total, uso, modificación y distribución de cada una de estas fotografías



WBC50210		WBC50211		WBC50212		WBC50213	
Referencia	Diámetro	Referencia	Diámetro	Referencia	Diámetro	Referencia	Diámetro
WC37081	19.0 - 3/4"	WC37109	22.2 - 7/8"	WC37110	19.0 - 3/4"	WC37111	17.4 - 11/16"
Posición	Marca	Posición	Marca	Posición	Marca	Posición	Marca
	CHEVROLET, PONTIAC	DELANTERO	VOLKSWAGEN		VOLKSWAGEN		VOLKSWAGEN

WBC50214		WBC50215		WBC50216		WBC50217	
Referencia	Diámetro	Referencia	Diámetro	Referencia	Diámetro	Referencia	Diámetro
WC37132	25.4 - 1"	WC37133	25.4 - 1"	WC37208	19.0 - 3/4"	WC37209	20.6 - 13/16"
Posición	Marca	Posición	Marca	Posición	Marca	Posición	Marca
IZQUIERDO	FORD	DERECHO	FORD		NISSAN	DELANTERO	NISSAN

WBC50219		WBC50220		WBC50221		WBC50222	
Referencia	Diámetro	Referencia	Diámetro	Referencia	Diámetro	Referencia	Diámetro
WC37218	26.9 - 1 1/16"	WC37219	26.9 - 1 1/16"	WC37235	23.8 - 15/16"	WC37250	30.1 - 1 3/16"
Posición	Marca	Posición	Marca	Posición	Marca	Posición	Marca
IZQUIERDO	DODGE	DERECHO	DODGE		CHRYSLER	DERECHO	FORD

WBC50223		WBC50224		WBC50225		WBC50228	
Referencia	Diámetro	Referencia	Diámetro	Referencia	Diámetro	Referencia	Diámetro
WC37251	30.1 - 1 3/16"	WC37262	26.9 - 1 1/16"	WC37263	26.9 - 1 1/16"	WC37274	20.6 - 13/16"
Posición	Marca	Posición	Marca	Posición	Marca	Posición	Marca
IZQUIERDO	FORD	IZQUIERDO	FORD	DERECHO	FORD		NISSAN

© Schaeffler Automotive Aftermarket México S. de R.L. de C.V. se reserva todos y cada uno de los derechos sobre las fotografías exclusivas de la marca aquí presentadas; se prohíbe la reproducción parcial y/o total, uso, modificación y distribución de cada una de estas fotografías



WBC50229		WBC50230		WBC50231		WBC50232	
Referencia	Diámetro	Referencia	Diámetro	Referencia	Diámetro	Referencia	Diámetro
WC37290	26.9 - 1 1/16"	WC37332	17.4 - 11/16"	WC37337	30.1 - 1 3/16"	WC37343	23.8 - 15/16"
Posición	Marca	Posición	Marca	Posición	Marca	Posición	Marca
	CHEVROLET, DODGE		VOLKSWAGEN		CHEVROLET		FORD, MERCURY

WBC50233		WBC50234		WBC50235		WBC50236	
Referencia	Diámetro	Referencia	Diámetro	Referencia	Diámetro	Referencia	Diámetro
WC37349	23.8 - 15/16"	WC37358	17.4 - 11/16"	WC37400	19.0 - 3/4"	WC37407	20.6 - 13/16"
Posición	Marca	Posición	Marca	Posición	Marca	Posición	Marca
	VOLKSWAGEN		NISSAN		FORD		NISSAN

WBC50237		WBC50238		WBC50239		WBC50240	
Referencia	Diámetro	Referencia	Diámetro	Referencia	Diámetro	Referencia	Diámetro
WC37459	23.8 - 15/16"	WC37531	17.4 - 11/16"	WC37564	15.8 - 5/8"	WC37574	19.0 - 3/4"
Posición	Marca	Posición	Marca	Posición	Marca	Posición	Marca
	TOYOTA		CHEVROLET, BUICK		CHRYSLER		FORD

WBC50241		WBC50242		WBC50243		WBC50244	
Referencia	Diámetro	Referencia	Diámetro	Referencia	Diámetro	Referencia	Diámetro
WC37590	14.2 - 9/16"	WC37591	22.2 - 7/8"	WC37592	22.2 - 7/8"	WC37599	22.2 - 7/8"
Posición	Marca	Posición	Marca	Posición	Marca	Posición	Marca
	CHRYSLER	DERECHO	FORD	IZQUIERDO	FORD		CHEVROLET, ISUZU

© Schaeffler Automotive Aftermarket México S. de R.L. de C.V. se reserva todos y cada uno de los derechos sobre las fotografías exclusivas de la marca aquí presentadas; se prohíbe la reproducción parcial y/o total, uso, modificación y distribución de cada una de estas fotografías



WBC50245		WBC50246		WBC50247		WBC50248	
Referencia	Diámetro	Referencia	Diámetro	Referencia	Diámetro	Referencia	Diámetro
WC37625	19.0 - 3/4"	WC37644	22.2 - 7/8"	WC37660	22.2 - 7/8"	WC37663	20.6 - 13/16"
Posición	Marca	Posición	Marca	Posición	Marca	Posición	Marca
	CHEVROLET		CHEVROLET, GMC		FORD		FORD, MAZDA

WBC50249		WBC50250		WBC50251		WBC50252	
Referencia	Diámetro	Referencia	Diámetro	Referencia	Diámetro	Referencia	Diámetro
WC37668	25.4 - 1"	WC37677	22.2 - 7/8"	WC37684	23.8 - 15/16"	WC37693	19.0 - 3/4"
Posición	Marca	Posición	Marca	Posición	Marca	Posición	Marca
	FORD		BUICK		NISSAN		NISSAN

WBC50253		WBC50254		WBC50255		WBC50256	
Referencia	Diámetro	Referencia	Diámetro	Referencia	Diámetro	Referencia	Diámetro
WC37709	22.2 - 7/8"	WC37750	15.8 - 5/8"	WC37751	19.0 - 3/4"	WC37752	19.0 - 3/4"
Posición	Marca	Posición	Marca	Posición	Marca	Posición	Marca
	DODGE, MITSUBISHI		CHEVROLET	IZQUIERDO	MAZDA	DERECHO	MAZDA

WBC50257		WBC50258		WBC50260		WBC50261	
Referencia	Diámetro	Referencia	Diámetro	Referencia	Diámetro	Referencia	Diámetro
WC37778	17.4 - 11/16"	WC37781	25.4 - 1"	WC37784	28.5 - 1 1/8"	WC37787	17.4 - 11/16"
Posición	Marca	Posición	Marca	Posición	Marca	Posición	Marca
	CHEVROLET, BUICK		CHEVROLET		CHEVROLET		DODGE, FORD

© Schaeffler Automotive Aftermarket México S. de R.L. de C.V. se reserva todos y cada uno de los derechos sobre las fotografías exclusivas de la marca aquí presentadas; se prohíbe la reproducción parcial y/o total, uso, modificación y distribución de cada una de estas fotografías



WBC50262		WBC50263		WBC50264		WBC50265	
Referencia	Diámetro	Referencia	Diámetro	Referencia	Diámetro	Referencia	Diámetro
WC37841	22.2 - 7/8"	WC37844	19.0 - 3/4"	WC37846	19.0 - 3/4"	WC37847	19.0 - 3/4"
Posición	Marca	Posición	Marca	Posición	Marca	Posición	Marca
	TOYOTA		CHRYSLER	DERECHO	HONDA	IZQUIERDO	HONDA

WBC50266		WBC50267		WBC50268		WBC50269	
Referencia	Diámetro	Referencia	Diámetro	Referencia	Diámetro	Referencia	Diámetro
WC37852	23.8 - 15/16"	WC37853	23.8 - 15/16"	WC37854	22.2 - 7/8"	WC37856	22.2 - 7/8"
Posición	Marca	Posición	Marca	Posición	Marca	Posición	Marca
DERECHO	CHEVROLET	IZQUIERDO	CHEVROLET		CHEVROLET		FORD, MAZDA

WBC50270		WBC50271		WBC50272		WBC50273	
Referencia	Diámetro	Referencia	Diámetro	Referencia	Diámetro	Referencia	Diámetro
WC37857	25.4 - 1"	WC37858	20.6 - 13/16"	WC37859	20.6 - 13/16"	WC37863	19.0 - 3/4"
Posición	Marca	Posición	Marca	Posición	Marca	Posición	Marca
	FORD, MERCURY, NISSAN	IZQUIERDO	HONDA	DERECHO	HONDA		CHRYSLER

WBC50274		WBC50275		WBC50276		WBC50277	
Referencia	Diámetro	Referencia	Diámetro	Referencia	Diámetro	Referencia	Diámetro
WC37864	15.8 - 5/8"		17.4 - 11/16"	WC37869	15.8 - 5/8"	WC37871	20.6 - 13/16"
Posición	Marca	Posición	Marca	Posición	Marca	Posición	Marca
	CHRYSLER		CHEVROLET		NISSAN		NISSAN

© Schaeffler Automotive Aftermarket México S. de R.L. de C.V. se reserva todos y cada uno de los derechos sobre las fotografías exclusivas de la marca aquí presentadas; se prohíbe la reproducción parcial y/o total, uso, modificación y distribución de cada una de estas fotografías



WBC50278		WBC50279		WBC50280		WBC50281	
Referencia	Diámetro	Referencia	Diámetro	Referencia	Diámetro	Referencia	Diámetro
WC37872	22.2 - 7/8"	WC37967	19.0 - 3/4"	WC37970	19.0 - 3/4"	WC37975	22.2 - 7/8"
Posición	Marca	Posición	Marca	Posición	Marca	Posición	Marca
	NISSAN		CHEVROLET, GMC		CHRYSLER, DODGE	DERECHO	CHEVROLET



WBC50282		WBC50283		WBC50284		WBC50285	
Referencia	Diámetro	Referencia	Diámetro	Referencia	Diámetro	Referencia	Diámetro
WC37976	22.2 - 7/8"	WC37984	17.4 - 11/16"	WC37985	23.8 - 15/16"	WC37986	19.0 - 3/4"
Posición	Marca	Posición	Marca	Posición	Marca	Posición	Marca
IZQUIERDO	CHEVROLET		CHRYSLER		CHEVROLET, CADILLAC, DODGE		VOLKSWAGEN, SEAT

WBC50286		WBC50287		WBC50289		WBC50290	
Referencia	Diámetro	Referencia	Diámetro	Referencia	Diámetro	Referencia	Diámetro
WC37997	22.2 - 7/8"	WC37999	23.8 - 15/16"	WC9025	25.4 - 1"	WC9026	25.4 - 1"
Posición	Marca	Posición	Marca	Posición	Marca	Posición	Marca
	FORD, MERCURY		FORD	IZQUIERDO	DODGE	DERECHO	DODGE





WBC50291		WBC50292		WBC50293		WBC50294	
Referencia	Diámetro	Referencia	Diámetro	Referencia	Diámetro	Referencia	Diámetro
3700908	20.6 - 13/16"	47550 OD010	19.0 - 3/4"	3700929	20.6 - 13/16"	3700928	20.6 - 13/16"
Posición	Marca	Posición	Marca	Posición	Marca	Posición	Marca
	FORD		TOYOTA	IZQUIERDO	PEUGEOT	DERECHO	PEUGEOT

© Schaeffler Automotive Aftermarket México S. de R.L. de C.V. se reserva todos y cada uno de los derechos sobre las fotografías exclusivas de la marca aquí presentadas; se prohíbe la reproducción parcial y/o total, uso, modificación y distribución de cada una de estas fotografías

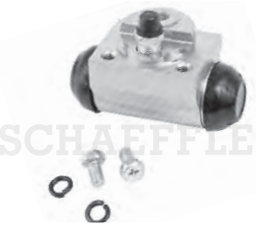

WBC50295		WBC50297		WBC50298		WBC50299	
Referencia	Diámetro	Referencia	Diámetro	Referencia	Diámetro	Referencia	Diámetro
3700916	22.2 - 7/8"	370143	22.2 - 7/8"	3700925	22.2 - 7/8"	3700920	17.4 - 11/16"
							
Posición	Marca	Posición	Marca	Posición	Marca	Posición	Marca
	CHEVROLET		TOYOTA		MITSUBISHI	DERECHO	HYUNDAI

WBC50300		WBC50301		WBC50302		WBC50306	
Referencia	Diámetro	Referencia	Diámetro	Referencia	Diámetro	Referencia	Diámetro
37009018	20.6 - 13/16"	37009019	20.6 - 13/16"	3700917	17.4 - 11/16"	MB366326	17.4 - 11/16"
							
Posición	Marca	Posición	Marca	Posición	Marca	Posición	Marca
DERECHO	FORD	IZQUIERDO	FORD	IZQUIERDO	HYUNDAI	IZQUIERDO	TOYOTA

WBC50307		WBC50308		WBC50309		WBC50310	
Referencia	Diámetro	Referencia	Diámetro	Referencia	Diámetro	Referencia	Diámetro
MB333468	17.4 - 11/16"	WC370115	20.6 - 13/16"	3700923	19.0 - 3/4"	WC370254	19.1 - 3/4"
							
Posición	Marca	Posición	Marca	Posición	Marca	Posición	Marca
DERECHO	TOYOTA		VOLKSWAGEN		CHEVROLET		NISSAN

WBC50311		WBC50312		WBC50313		WBC50314	
Referencia	Diámetro	Referencia	Diámetro	Referencia	Diámetro	Referencia	Diámetro
WC370113	19.0 - 3/4"	2H0 611 053	26.9 - 1 1/16"	370240	30.1 - 1 3/16"	370247	30.1 - 1 3/16"
							
Posición	Marca	Posición	Marca	Posición	Marca	Posición	Marca
	VOLKSWAGEN / SEAT		VOLKSWAGEN	TRAS. DER. TRAS.	ISUZU	TRAS. IZQ. TRAS.	ISUZU

© Schaeffler Automotive Aftermarket México S. de R.L. de C.V. se reserva todos y cada uno de los derechos sobre las fotografías exclusivas de la marca aquí presentadas; se prohíbe la reproducción parcial y/o total, uso, modificación y distribución de cada una de estas fotografías



WBC50315		WBC50316		WBC50318		WBC50319	
Referencia	Diámetro	Referencia	Diámetro	Referencia	Diámetro	Referencia	Diámetro
WC37646	17.4 - 11/16"	WC37637	17.4 - 11/16"		22.2 - 7/8"	WC37850	15.8 - 5/8"
Posición	Marca	Posición	Marca	Posición	Marca	Posición	Marca
	USA		USA		USA		USA

WBC50320		WBC50321		WBC50322		WBC50323	
Referencia	Diámetro	Referencia	Diámetro	Referencia	Diámetro	Referencia	Diámetro
	19.1 - 3/4"	WC37601	20.6 - 13/16"	WC37602	20.6 - 13/16"	WC37708	22.2 - 7/8"
Posición	Marca	Posición	Marca	Posición	Marca	Posición	Marca
	USA		USA		USA		USA

WBC50324		WBC50325		WBC50327		WBC50331	
Referencia	Diámetro	Referencia	Diámetro	Referencia	Diámetro	Referencia	Diámetro
WC37710	23.8 - 15/16"	WC37711	23.8 - 15/16"	60 01 549 707	19.0	44100-4JAOA	25.4 - 1"
Posición	Marca	Posición	Marca	Posición	Marca	Posición	Marca
	USA	DERECHO	USA		RENAULT		NISSAN

WBC50332		WBC50333		WBC50334		WBC50335	
Referencia	Diámetro	Referencia	Diámetro	Referencia	Diámetro	Referencia	Diámetro
1782880	20.6 - 13/16"	1717334	23.8 - 15/16"	3700922	15.8 - 5/8"	58330-4H000	22.2 - 7/8"
Posición	Marca	Posición	Marca	Posición	Marca	Posición	Marca
	FORD		FORD		DODGE i10 12-14		DODGE

© Schaeffler Automotive Aftermarket México S. de R.L. de C.V. se reserva todos y cada uno de los derechos sobre las fotografías exclusivas de la marca aquí presentadas; se prohíbe la reproducción parcial y/o total, uso, modificación y distribución de cada una de estas fotografías



WBC50336		WBC50337		WBC50338		WBC50339	
Referencia	Diámetro	Referencia	Diámetro	Referencia	Diámetro	Referencia	Diámetro
WC370241	30.1 - 1 3/16"	WC370239	30.1 - 1 3/16"	WC370255	19.1 - 3/4"	44100-VK00A	23.8 - 15/16"
Posición	Marca	Posición	Marca	Posición	Marca	Posición	Marca
TRAS. IZQ. DEL.	ISUZU	TRAS. DER. DEL.	ISUZU		NISSAN		NISSAN

WBC50340		WBC50341		WBC50342		WBC50343	
Referencia	Diámetro	Referencia	Diámetro	Referencia	Diámetro	Referencia	Diámetro
8-97349-689-0	25.4 - 1"	8-97349-692-0	25.4 - 1"	8-97349-690-0	25.4 - 1"	48 45 031 010	15.8 - 5/8"
Posición	Marca	Posición	Marca	Posición	Marca	Posición	Marca
TRAS. IZQ. DEL/TAS	ISUZU	TRAS. DER. TAS.	ISUZU	TRAS. DER. DEL.	ISUZU		RENAULT

WBC50344		WBC50345		WBC50346		WBC50347	
Referencia	Diámetro	Referencia	Diámetro	Referencia	Diámetro	Referencia	Diámetro
WC370232	20.6 - 13/16"	WC370253	17.8 - 0	37866	19.1 - 3/4"	37300401MX	19.1 - 3/4"
Posición	Marca	Posición	Marca	Posición	Marca	Posición	Marca
	HONDA		DODGE, HYUNDAI		MAZDA, TOYOTA		VW, SEAT

WBC50348		WBC50349		WBC50350		WBC50352	
Referencia	Diámetro	Referencia	Diámetro	Referencia	Diámetro	Referencia	Diámetro
77 01 047 838	17.4 - 11/16"	37030405MX	23.8 - 15/16"	37030416MX	22.2 - 7/8"	44100-3XE0A	19.1 - 3/4"
Posición	Marca	Posición	Marca	Posición	Marca	Posición	Marca
	RENAULT		CHEVROLET		CHEVROLET		NISSAN

© Schaeffler Automotive Aftermarket México S. de R.L. de C.V. se reserva todos y cada uno de los derechos sobre las fotografías exclusivas de la marca aquí presentadas; se prohíbe la reproducción parcial y/o total, uso, modificación y distribución de cada una de estas fotografías



WBC50353		WBC50354		WBC50355		WBC50356	
Referencia	Diámetro	Referencia	Diámetro	Referencia	Diámetro	Referencia	Diámetro
47550-26150	25.4 - 1"	37090413MX	19.1 - 3/4"	WC370121	20.6 - 13/16"	772 9634	20.6 - 13/16"
Posición	Marca	Posición	Marca	Posición	Marca	Posición	Marca
	TOYOTA		FORD		FORD		FIAT

WBC50357		WBC50359		WBC50360		WBC50361	
Referencia	Diámetro	Referencia	Diámetro	Referencia	Diámetro	Referencia	Diámetro
37210402MX	23.8 - 15/16"	708 9425	20.6 - 13/16"	16 071 388 80	20.6 - 13/16"	37350411MX	20.6 - 13/16"
Posición	Marca	Posición	Marca	Posición	Marca	Posición	Marca
	NISSAN		FIAT, RAM		PEUGEOT		FIAT, RAM

WBC50362		WBC50363		WBC50364		WBC50365	
Referencia	Diámetro	Referencia	Diámetro	Referencia	Diámetro	Referencia	Diámetro
47550-0K010	23.8 - 15/16"	26692590	19.1 - 3/4"	37030417MX	19.1 - 3/4"	5Z0 611 053	17.4 - 11/16"
Posición	Marca	Posición	Marca	Posición	Marca	Posición	Marca
	TOYOTA		CHEVROLET		CHEVROLET		VOLKSWAGEN

WBC50366		WBC50367		WBC50368		WBC50369	
Referencia	Diámetro	Referencia	Diámetro	Referencia	Diámetro	Referencia	Diámetro
370278	19.1 - 3/4"	370277	19.1 - 3/4"	37030414MX	19.1 - 3/4"	44100-4KH0B	25.4 - 1"
Posición	Marca	Posición	Marca	Posición	Marca	Posición	Marca
DERECHO	NISSAN	IZQUIERDO	NISSAN		CHEVROLET		NISSAN

© Schaeffler Automotive Aftermarket México S. de R.L. de C.V. se reserva todos y cada uno de los derechos sobre las fotografías exclusivas de la marca aquí presentadas; se prohíbe la reproducción parcial y/o total, uso, modificación y distribución de cada una de estas fotografías

AIMCO	FAG
3110	BFR520310
3120	BFR537350
3132	BFR520610
3140	BFR585250
3172	BFR507150
3214	BFR523210
3216	BFR522210
3217	BFR520710
3222	BFR133710
3231	BFR594050
3233	BFR133610
3237	BFR538150
3257	BFR537250
3270	BFR537850
3287	BFR510110
3289	BFR537650
3290	BFR537150
3295	BFR511010
3406	BFR370310
3416	BFR370110
3445	BFR380210
3460	BFR370410
3464	BFR370510
3464	BFR360110
3483	BRR370110
3509	BRD521310
3517	BRD132410
3518	BRD132310
3536	BRD520810
3558	BRD536050
3569	BRD510110
3578	BRD536150
3806	BFD370110
3812	BRD370310
3814	BRD370210
3820	BRD370410
3824	BRD370510
5115	BFR112710
5118	BFR114010
5119	BRR111210
5329	BFR110910
5333	BFR112310
5346	BFR112610
5347	BFR112510
5357	BFR113010
5359	BFR111510
5360	BRR110810

AIMCO	FAG
5361	BFR110410
5362	BFR111610
5370	BRR110610
5373	BFR113410
5382	BFR113310
5383	BRR110910
5393	BFR112910
5395	BFR114710
5396	BFR116010
5397	BFR114210
5399	BFR540310
5440	BFR120110
5447	BFR122810
5456	BFR126410
5457	BFR122510
5467	BFR123410
5473	BFR123310
5474	BFR126010
5485	BRR121410
5516	BFR132110
5547	BFR130410
5570	BFR132510
5571	BFR132610
5575	BFR132710
5580	BFR131110
5583	BRR130310
5584	BFR134510
5595	BFR132910
5598	BFR133010
8898	BRD130310
8939	BRD130610
8947	BRD110910
8948	BRD111010
8957	BRD111810
8968	BRD111910
8972	BRD131410
8974	BRD123910
8988	BRD131610
8989	BRD122710
8998	BRD131910
31015	BFR566050
31017	BFR133410
31025	BFR520410
31029	BFR510210
31046	BRR520810
31050	BFR530210
31052	BFR585150

AIMCO	FAG
31056	BFR537050
31057	BFR521310
31073	BFR133910
31123	BFR521510
31146	BFR537750
31148	BRR520410
31158	BFR521710
31165	BFR537450
31169	BFR521610
31204	BFR537550
31208	BFR538050
31232	BFR556050
31239	BFR545150
31243	BFR510310
31244	BRR510410
31245	BRR510310
31250	BFR522310
31257	BFR510410
31259	BFR523010
31263	BFR541010
31264	BRR530310
31265	BFR530710
31270	BFR530110
31275	BFR510710
31284	BFR585050
31287	BFR540410
31288	BRR540310
31291	BFR540510
31293	BFR530910
31294	BRR530110
31295	BFR530810
31296	BFR590110
31299	BFR538350
31300	BFR545050
31304	BRR510510
31305	BFR510610
31306	BFR522110
31307	BFR523110
31311	BFR510910
31312	BRR521110
31314	BFR530310
31315	BRR510810
31318	BRR510610
31319	BFR507250
31320	BFR507350
31321	BFR115610
31322	BRR530210

AIMCO	FAG
31323	BFR560110
31325	BRR123110
31326	BFR530510
31327	BFR530410
31328	BFR523310
31329	BRR521210
31337	BFR507050
31343	BFR540610
31348	BRR521310
31349	BRR521610
31353	BRR540510
31357	BRR530510
31360	BRR540410
31361	BRR530410
31363	BFR580510
31365	BRR580610
31366	BRR580510
31368	BFR511210
31369	BRR511210
31372	BRR511110
31373	BFR580410
31375	BFR522410
31381	BFR510510
31389	BFR524110
31390	BFR136510
31398	BRR511310
31401	BFR540810
31402	BFR511310
31410	BRR521910
31411	BFR523910
31412	BFR524010
31418	BFR523410
31420	BRR511010
31429	BRR522010
31432	BFR111010
31433	BRR530610
31434	BFR531110
31435	BRR580410
31439	BFR531310
31440	BFR531510
31443	BRR531010
31454	BFR560410
31455	BFR511110
31459	BRR580310
31460	BFR580110
31463	BFR524410
31464	BFR523610



AIMCO	FAG
31468	BFR511410
31469	BRR510910
31479	BRR511710
31480	BRR580110
31481	BFR580210
31482	BFR531710
31483	BRR531110
31488	BRR540810
31498	BRR560110
31499	BFR560210
31505	BFR531910
31506	BFR524710
31507	BRR530910
31508	BRR531410
31511	BFR532210
31512	BFR520810
31513	BFR523510
31530	BRR521810
31538	BFR512010
31540	BRR560310
31544	BRR531510
31545	BFR523710
31554	BFR538450
31568	BFR580710
31601	BFR512410
31612	BRR113510
31623	BFR580810
31626	BFR580810
34010	BFR371110
34011	BRR370210
34023	BRR370310
34055	BFR371710
34059	BFR370610
34143	BFR370710
34144	BRR370510
34168	BFR371310
34173	BFR320310
34184	BFR320110
34220	BRR320610
34222	BFR371610
34226	BFR340110
34227	BRR340110
34231	BFR320810
34232	BRR320210
34243	BRR370610
34245	BFR375910
34248	BFR420510

AIMCO	FAG
34251	BFR126910
34252	BRR121510
34279	BFR371910
34284	BFR321810
34287	BRR373210
34294	BRR372010
34303	BFR372210
34308	BFR372510
34312	BFR323110
34315	BRR322710
34347	BRR410410
34349	BFR410710
34364	BFR410410
34366	BRR320310
34367	BFR320610
34368	BFR320510
34399	BRR370910
34403	BRR371510
34406	BFR370810
34431	BRR374710
35024	BRD520710
35083	BRD595050
35089	BRD530110
35094	BRD510510
35102	BRD113510
35113	BRD510210
35125	BRD560210
35135	BRD521710
35139	BRD120410
35148	BRD120510
53000	BFR113810
53001	BFR114910
53002	BFR110110
53004	BFR114410
53005	BFR115310
53006	BRR110410
53010	BRR110710
53011	BRR111810
53012	BFR115910
53020	BRR340210
53021	BRR111510
53022	BFR113510
53023	BFR113210
53024	BRR111110
53025	BFR116410
53026	BFR111110
53027	BRR112010

AIMCO	FAG
53028	BFR340210
53029	BFR113610
53036	BRR112210
53037	BFR111910
53038	BFR111410
53040	BFR111710
53041	BRR112310
53042	BFR116710
53043	BRR112410
53044	BRR113010
53047	BRR342910
53048	BRR343010
53049	BFR343910
53050	BRR112910
53051	BFR114810
53056	BRR113110
53057	BFR116810
53061	BRR112810
53062	BFR116610
53063	BRR113210
53064	BFR117010
53068	BFR117110
53069	BRR113410
54002	BFR123710
54003	BFR520110
54010	BFR122210
54012	BFR122010
54013	BFR123810
54017	BRR120510
54018	BFR124410
54021	BFR124110
54024	BFR123910
54029	BFR124610
54031	BFR124210
54032	BRR121010
54035	BFR126610
54037	BRR120910
54039	BFR124010
54040	BFR124810
54044	BFR124910
54047	BRR121110
54050	BFR125110
54064	BRR121210
54068	BFR125010
54069	BFR124810
54070	BFR126710
54073	BRR121710

AIMCO	FAG
54074	BRR121810
54076	BFR125410
54077	BFR220410
54079	BFR126310
54090	BRR123010
54091	BFR221410
54092	BFR124710
54093	BFR127410
54094	BFR120510
54096	BFR128010
54097	BFR121010
54098	BRR122510
54099	BFR128210
54100	BRR122010
54107	BFR120910
54109	BFR221510
54111	BRR122210
54117	BRR122310
54118	BFR120310
54123	BFR120210
54124	BFR125610
54125	BRR123210
54127	BFR126810
54128	BFR220610
54131	BRR124110
54132	BFR125710
54133	BFR220110
54134	BFR129710
54137	BRR124310
54138	BRR124710
54142	BFR128810
54143	BFR129910
54152	BRR123510
54153	BFR124310
54154	BFR123110
54156	BRR123410
54159	BFR127110
54162	BRR124810
54164	BFR220910
54171	BFR221710
54176	BFR221110
54182	BRR125110
54186	BRR125210
54196	BFR221910
55029	BFR133110
55031	BRR131010
55036	BFR131810

AIMCO	FAG
55040	BFR131710
55047	BFR133310
55049	BRR131210
55054	BFR134410
55055	BRR132510
55060	BFR135110
55062	BFR136210
55066	BRR131610
55067	BRR131710
55069	BFR135210
55070	BFR134610
55073	BRR131810
55075	BRR132810
55079	BFR135310
55080	BFR135510
55090	BFR135610
55093	BFR132410
55094	BRR132610
55095	BFR136410
55097	BFR137310
55099	BFR137410
55118	BFR136910
55119	BRR133110
55122	BFR137510
55131	BRR133610
55133	BRR133410
55147	BRR133710
55148	BFR137110
55150	BFR137210
55151	BRR134410
55159	BRR531310
55162	BFR138210
55174	BFR138510
55178	BRR135410
55179	BRR134710
55183	BRR134110
55184	BFR136010
55185	BFR139010
55191	BFR139410
55194	BRR135210
55199	BRR134610
80002	BRD112010
80021	BRD112710
80023	BRD122810
80078	BRD123510
80090	BRD123210
80093	BRD521510

AIMCO	FAG
80098	BRD124210
80104	BRD530410
80115	BRD133710
80118	BRD133210
80119	BRD110810
80120	BRD133610
80122	BRD131510
80125	BRD113910
Raybestos	FAG
8512	BFR134510
9109	BRD370210
9226	BFR370310
9532	BRD130310
9711	BRD124210
9714	BRD595050
9725	BRD530410
9733	BRD122810
9765	BRD110810
9769	BRD133610
9771	BRD131510
9774	BRD131510
9777	BRD110810
96817	BFR585050
96973	BFR545050
580184	BFR132410
580243	BRR132610
580244	BFR136410
580371	BFR136910
580373	BRR133110
581851	BFR134010
680093	BFR124610
680178	BFR120920
680190	BFR120310
680191	BRR121210
680319	BFR125710
680326	BFR129710
680507	BRR123510
680639	BFR127110
780196	BRR340210
780256	BFR113210
780258	BFR116410
780289	BFR111110
780346	BFR340210
780389	BFR113610
780541	BRR112410
780612	BRR342910
780613	BRR343010

Raybestos	FAG
780683	BFR114810
780690	BFR113610
980051	BFR590110
980057	BFR420510
980089	BFR507050
980172	BRR123110
980187	BRR540510
980197	BFR523310
980213	BRR530510
980283	BFR580510
980285	BRR580610
980290	BFR511210
980307	BFR522410
980317	BFR510510
980383	BFR371910
980388	BFR523410
980402	BRR511010
980423	BRR372010
980456	BFR372210
980471	BFR372510
980482	BFR323110
980490	BRR322710
980550	BRR410410
980566	BFR511410
980594	BRR540810
980601	BFR410410
980603	BFR320610
980604	BRR320310
980605	BFR320610
980624	BFR114810
980632	BRR531410
980638	BFR523510
980694	BRR371510
980697	BFR370810
980738	BFR512010
980784	BFR538450
980941	BFR370810
981026	BFR580810
190R	BRD132510
2051R	BRD130610
2093R	BRD130310
2324R	BRD123910
2469R	BRD112010
2572R	BRD131410
2583R	BRD132310
2585R	BRD131610
2905R	BRD111810

Raybestos	FAG
2907R	BRD111010
2913R	BRD110910
2987R	BRD111910
5006R	BFR132110
5064R	BFR130410
56137R	BFR132710
56140R	BFR131110
56148R	BFR566050
56170R	BFR133410
56258R	BFR132910
56263R	BFR133010
56493R	BRR131010
56496R	BFR133110
56631R	BFR131810
56655R	BFR131710
56694R	BFR133310
56725R	BRR131210
56757R	BFR132710
56825R	BFR134410
56827R	BRR131610
56828R	BRR132510
56829R	BFR136210
56919R	BRR131710
56927R	BFR135110
56992R	BRR132810
56998R	BFR134610
580019R	BFR135210
580023R	BFR135310
580029R	BRR131810
580083R	BFR135510
580165R	BRR131710
580212R	BFR137410
580216R	BFR135610
580279R	BFR137310
580382R	BFR137510
580409R	BRR133610
580543R	BRR133710
580547R	BFR137110
580560R	BFR137210
580569R	BRR134410
580665R	BRR131410
580704R	BRR531310
580709R	BFR138210
580746R	BFR138510
580763R	BRR135410
580769R	BRR134610
580770R	BFR139010



Raybestos	FAG
580770R	BFR232210
580771R	BRR134710
580838R	BRR134110
580839R	BFR136010
580846R	BFR134310
580849R	BFR133910
580850R	BRR131510
580875R	BFR139410
580895R	BRR135210
581025R	BFR231510
581032R	BRR133410
581034R	BFR231510
582038R	BFR231310
582039R	BRR136310
582457R	BRR137110
582458R	BFR232410
582623R	BFR230410
5976R	BFR132510
6032R	BFR126410
6050R	BFR122510
6082R	BFR120110
6129R	BRR121410
6131R	BFR126010
6326R	BFR123710
66032R	BFR123410
66327R	BFR520110
66416R	BFR123310
66442R	BFR122210
66445R	BFR123810
66448R	BRR120510
66455R	BFR123910
66489R	BFR122010
66527R	BFR124110
66528R	BFR124210
66548R	BRR120910
66559R	BFR124410
66565R	BRR121010
66576R	BFR126610
66597R	BFR124610
66603R	BFR124010
66647R	BFR124910
66653R	BFR125110
66670R	BRR121110
66761R	BRR121210
66768R	BFR125410
66799R	BRR121710
66821R	BFR124810

Raybestos	FAG
66822R	BFR125010
66823R	BRR121810
66833R	BFR126710
66913R	BFR126310
66924R	BFR220410
66947R	BRR123010
66984R	BFR221410
66997R	BFR124710
680014R	BFR120510
680021R	BFR128010
680025R	BFR127410
680026R	BRR122510
680027R	BFR121010
680105R	BFR128210
680106R	BRR122010
680180R	BFR221510
680182R	BRR122210
680189R	BRR122310
680272R	BFR120210
680280R	BFR125610
680281R	BRR123210
680286R	BFR126810
680305R	BFR220610
680318R	BRR124110
680320R	BFR220110
680344R	BRR125310
680363R	BRR124310
680374R	BRR124710
680404R	BFR128810
680416R	BFR129910
680508R	BFR124310
680544R	BFR123110
680546R	BRR123410
680679R	BRR124810
680681R	BFR220910
680686R	BRR123210
680758R	BFR221710
680822R	BFR127810
680855R	BFR126210
680930R	BFR221610
680931R	BRR125110
680976R	BRR125210
680998R	BFR410710
680999R	BRR125610
681012R	BRR125410
681013R	BRR125710
681014R	BFR221910

Raybestos	FAG
681018R	BRR126410
681027R	BRR125810
681028R	BFR221810
681781R	BFR128110
681785R	BFR222610
681951R	BRR126210
6865R	BFR122810
7009R	BFR112310
7063R	BFR110910
7142R	BFR112710
76161R	BFR112610
76247R	BFR112510
76446R	BFR113010
76451R	BRR110810
76466R	BFR111510
76504R	BFR110410
76505R	BFR111610
76547R	BRR110610
76645R	BFR113310
76646R	BFR113410
76650R	BRR110910
76793R	BFR114010
76794R	BRR111210
76912R	BFR114210
76918R	BFR114710
76920R	BFR112910
76921R	BFR540310
76923R	BFR116010
76955R	BFR113810
780036R	BFR114910
780037R	BFR110110
780049R	BFR114410
780073R	BFR115310
780082R	BRR110410
780134R	BRR110710
780139R	BRR111810
780143R	BFR115910
780254R	BRR111510
780255R	BFR113510
780296R	BRR112010
780457R	BRR112210
780458R	BFR111910
780459R	BFR111410
780518R	BFR111710
780519R	BRR112310
780540R	BFR116710
780542R	BRR113010

Raybestos	FAG
780614R	BFR343910
780623R	BRR112910
780733R	BRR113110
780736R	BFR116810
780867R	BRR112810
780868R	BFR116610
780869R	BRR113210
780870R	BFR117010
780964R	BFR117110
780965R	BRR113410
781049R	BRR111110
781099R	BRR113810
781109R	BRR114010
781138R	BRR114110
781766R	BFR117310
781768R	BFR116510
8004R	BFR132610
8510R	BRR130310
8810R	BFR531010
8820R	BFR113710
8830R	BFR126110
8840R	BFR134810
8910R	BRD123610
9106R	BRD132410
9107R	BRD370310
9153R	BRD370510
9228R	BFR370110
9311R	BRD510110
9328R	BRD536050
9330R	BRD521310
9343R	BRD370410
9433R	BRD520710
9480R	BRD520810
9498R	BRD122710
9517R	BFD370110
9530R	BRD131910
9545R	BRD536150
9556R	BRD370210
96007R	BFR133610
96008R	BFR133710
96011R	BFR520410
96013R	BFR585250
96020R	BFR537650
96027R	BFR537850
96034R	BFR594050
96039R	BFR537350
96049R	BFR537250

Raybestos	FAG
96087R	BFR511010
96111R	BFR510110
96133R	BRR520810
96147R	BFR510210
96154R	BRR520410
96209R	BFR537150
96217R	BFR530210
9622R	BRD112710
9626R	BRD122810
9628R	BRD112710
9630R	BRD520710
96318R	BFR585150
96354R	BFR537050
96363IR	BFR521310
96421R	BFR371710
96423R	BRR370310
96430R	BRR370210
96566R	BFR537750
96575R	BFR537450
96589R	BFR521610
96598R	BFR521510
96613R	BFR538050
96615R	BFR521710
9661R	BRD123510
96632R	BFR537550
96682R	BFR370610
96687R	BFR545150
96708R	BRR510410
96709R	BFR510310
96710R	BRR510310
96711R	BFR510410
96720R	BFR522310
96737R	BFR556050
96751R	BFR523010
96778R	BFR370710
96779R	BRR370510
96795R	BFR510710
96796R	BRR530310
96797R	BFR530710
96806R	BFR371310
96807R	BFR541010
96929R	BRR530110
96934R	BFR530110
96972R	BFR538350
96974R	BFR540510
96975R	BFR540410
96983R	BRR540310

Raybestos	FAG
96986R	BFR530910
9706R	BRD521510
9724R	BRD510510
9734R	BRD530110
9748R	BRD113510
9759R	BRD123210
9764R	BRD133210
9775R	BRD510210
9776R	BRD111110
9779R	BRD530710
9780R	BRD530510
97811R	BRD120410
97812R	BRD134110
97814R	BRD110310
97816R	BRD350210
9781R	BRD133710
97821R	BRD120510
97824R	BRD370810
97826R	BRD131210
97827R	BRD350110
97829R	BRD371010
9782R	BRD113910
97835R	BRD111310
97836R	BRD521910
97841R	BRD134310
97848R	BRD120410
97854R	BRD380110
97860R	BRD380210
97865R	BRD522010
97866R	BRD111110
97868R	BRD510610
97871R	BRD530310
97875R	BRD370110
97907R	BRD522110
97914R	BRD530910
9791R	BRD560210
9792R	BRD120110
9796R	BRD521810
9797R	BRD531010
980011R	BFR320310
980017R	BFR320110
980030R	BFR560110
980032R	BRR510610
980033R	BFR530810
980059R	BFR510910
980070R	BRR521110
980071R	BRR510510

Raybestos	FAG
980072R	BFR510610
980074R	BFR522110
980075R	BFR523110
980076R	BRR530210
980077R	BFR530310
980098R	BFR507250
980112R	BFR507350
980113R	BRR521610
980116R	BFR524110
980127R	BRR320610
980131R	BFR371610
980138R	BRR510810
980153R	BFR320810
980154R	BRR320210
980155R	BRR521310
980158R	BFR340110
980160R	BFR530510
980161R	BFR530410
980163R	BFR115610
980164R	BRR340110
980186R	BFR540610
980198R	BRR521210
9801R	BRD134010
980208R	BRR540410
980210R	BRR530410
980230R	BRR373210
980234R	BFR126910
980235R	BRR121510
980261R	BRR370610
980267R	BFR375910
980287R	BRR580510
980291R	BRR511210
980294R	BRR511110
980295R	BFR580410
980338R	BFR136510
980349R	BRR511310
980352R	BFR540810
980353R	BFR511310
980368R	BRR521910
980369R	BFR523910
980370R	BFR524010
980397R	BFR321810
980452R	BFR111010
980462R	BRR522010
980467R	BRR530610
980470R	BFR531110
980472R	BRR580410

Raybestos	FAG
980476R	BFR531310
980477R	BFR531510
980483R	BRR531010
980509R	BFR560410
980515R	BFR511110
980523R	BRR580310
980524R	BFR580110
980552R	BFR410710
980561R	BFR524410
980562R	BFR523610
980567R	BRR510910
980577R	BRR511710
980579R	BRR580110
980580R	BFR580210
980583R	BFR531710
980584R	BRR531110
980606R	BFR320510
980610R	BRR560110
980611R	BFR560210
980627R	BFR540310
980629R	BFR531910
980630R	BFR524710
980631R	BRR530910
980636R	BFR532210
980637R	BFR520810
980666R	BFR510710
980670R	BFR530410
980684R	BRR370910
9806R	BRD521710
980700R	BFR522410
980710R	BRR521810
980747R	BRR560310
980755R	BFR531010
980757R	BRR531510
980764R	BFR523710
980780R	BRR530110
980781R	BFR531110
980783R	BRR501010
980798R	BRR374710
980822R	BFR221110
980843R	BFR370910
980844R	BFR350610
980847R	BFR370310
980848R	BFR115010
980853R	BFR380110
980856R	BFR380310
980859R	BFR371210



Raybestos	FAG
980859R	BRR370410
980860R	BFR115110
980861R	BFR381010
980863R	BFR580710
980874R	BRR375010
980887R	BRR389710
980888R	BRR350110
980889R	BFR390110
980897R	BFR500310
980903R	BFR377010
980904R	BFR520510
980946R	BFR532310
980948R	BFR371810
980949R	BRR390210
980950R	BFR390310
980952R	BFR512410
980957R	BRR500310
980972R	BRR530810
980978R	BFR114610
980979R	BFR500910
980980R	BRR113510
980981R	BFR525110
981001R	BFR510410
981008R	BRR580210
981010R	BFR500710
981011R	BFR580810
981022R	BFR512310
981037R	BFR512310
981040R	BFR511910
981041R	BRR511110
981053R	BFR512610
981055R	BFR525510
981056R	BRR541010
981057R	BFR525510
981067R	BFR541410
981150R	BFR380210
981199R	BFR512710
981367R	BFR350510
981421R	BFR580910
981470R	BFR525810
981500R	BRR580810
981503R	BFR581210
981622R	BFR115710
981773R	BFR526310
981779R	BFR526410
981780R	BFR525410
981914R	BFR376010

Raybestos	FAG
981937R	BFR374510
981958R	BFR500510
982008R	BRR580910
982043R	BFR115410
982048R	BFR580710
982071R	BFR532710
982073R	BRR512810
982091R	BFR115810
982104R	BRR501410
982124R	BFR512910
982264R	BFR581010
982407R	BFR526110
9834R	BFR520310
9837R	BFR537950
9838R	BFR538150
9900R	BFR370410
9908R	BFR522210
9909R	BFR523210
9915R	BFR520710
9920R	BFR520610
9933R	BFR370510
9933R	BFR360110
9934R	BRR370110
9968R	BFR507150
Autopar/Fritec	FAG
FR03023	BFR320110
FR02013	BRR371510
FR02014	BFR370810
FR03009	BRR320610
FR03013	BFR320310
FR03024	BFR320810
FR03025	BRR320210
FR03029	BRR320310
FR03030	BFR320510
FR03031	BFR321810
FR05009	BFR112310
FR05010	BFR110910
FR05013	BFR114210
FR05016	BFR113010
FR05017	BFR111510
FR05018	BRR110810
FR05021	BFR111610
FR05022	BFR110410
FR05023	BRR110610
FR05024	BFR112710
FR05026	BFR114710
FR05029	BFR112610

Autopar/Fritec	FAG
FR05030	BFR116010
FR05035	BFR113310
FR05036	BFR113410
FR05037	BRR110910
FR05038	BFR113810
FR05042	BFR110110
FR05043	BFR113710
FR05044	BFR115010
FR05045	BFR114010
FR05046	BRR111210
FR05049	BRR110710
FR05050	BFR540310
FR05052	BFR115610
FR05053	BFR115110
FR05054	BFR114410
FR05056	BFR114910
FR05059	BRR111110
FR05063	BRR110410
FR05064	BFR115310
FR05066	BFR112910
FR05068	BRR111810
FR05069	BRR112010
FR05070	BFR116410
FR05071	BFR113610
FR05073	BFR113210
FR05074	BFR113510
FR05075	BFR111910
FR05076	BFR116710
FR05077	BRR113010
FR05078	BRR112210
FR05079	BFR111010
FR05080	BFR111410
FR05081	BRR112410
FR05082	BFR114810
FR05083	BRR112910
FR05085	BFR111710
FR05086	BRR112310
FR05087	BFR111110
FR05088	BFR116210
FR05089	BFR115410
FR05091	BFR116610
FR05093	BFR115810
FR05099	BRR113410
FR05103	BRR111510
FR05104	BRR113810
FR05105	BFR115910
FR05109	BRR113110

Autopar/Fritec	FAG
FR05110	BFR116810
FR05113	BFR112510
FR07001	BFR390110
FR07003	BRR390210
FR08005	BFR120110
FR08012	BFR126410
FR08013	BFR126110
FR08014	BRR121110
FR08019	BFR123810
FR08020	BFR122810
FR08023	BFR122510
FR08024	BFR123410
FR08025	BFR123310
FR08029	BFR122210
FR08030	BFR122010
FR08032	BFR123710
FR08033	BFR125010
FR08044	BFR126210
FR08045	BRR121410
FR08046	BFR126010
FR08053	BRR120510
FR08054	BFR123910
FR08056	BFR124110
FR08058	BRR121010
FR08059	BRR120910
FR08060	BFR124010
FR08061	BFR124410
FR08063	BFR124610
FR08065	BFR125110
FR08066	BFR124910
FR08068	BRR121210
FR08070	BFR124810
FR08071	BRR121810
FR08072	BFR126710
FR08073	BFR126310
FR08074	BFR124210
FR08078	BRR123010
FR08079	BFR127410
FR08081	BFR126610
FR08082	BFR126910
FR08083	BRR121510
FR08086	BRR122510
FR08088	BRR122310
FR08091	BFR120510
FR08093	BRR122010
FR08094	BFR128210
FR08095	BFR120310

Autopar/Fritec	FAG	Autopar/Fritec	FAG	Autopar/Fritec	FAG	Autopar/Fritec	FAG
FR08096	BFR120210	FR09019	BFR132610	FR09110	BRR133710	FR10035	BFR512010
FR08099	BRR122210	FR09020	BFR131110	FR09111	BFR420510	FR10041	BFR511910
FR08101	BFR221510	FR09021	BFR133410	FR09113	BFR138210	FR10042	BFR512610
FR08102	BFR220410	FR09023	BFR132710	FR09119	BFR139910	FR10043	BFR512310
FR08104	BFR120910	FR09024	BFR132510	FR09120	BFR136210	FR10046	BFR512710
FR08108	BFR124710	FR09026	BFR132910	FR09122	BFR136910	FR10047	BFR512910
FR08109	BFR128010	FR09030	BFR134510	FR09123	BFR230010	FR11001	BFR110610
FR08112	BRR123410	FR09031	BRR130310	FR09124	BRR135210	FR11002	BFR115710
FR08113	BFR410410	FR09034	BFR133710	FR09125	BFR139410	FR11003	BFR500110
FR08114	BRR410410	FR09038	BFR131810	FR09127	BRR133610	FR11006	BFR500310
FR08115	BFR128810	FR09041	BRR131010	FR09128	BRR131210	FR11007	BRR500310
FR08116	BRR123110	FR09043	BFR131710	FR09131	BFR139010	FR11011	BRR113510
FR08117	BFR125410	FR09047	BFR132710	FR09132	BRR134610	FR11012	BRR501010
FR08118	BRR123210	FR09048	BFR134410	FR09137	BFR138510	FR11013	BFR500710
FR08119	BFR220610	FR09049	BRR131610	FR09138	BFR231510	FR11014	BRR501410
FR08120	BRR124710	FR09051	BRR131710	FR09139	BFR230110	FR12001	BFR590110
FR08121	BFR125610	FR09052	BFR135110	FR09141	BRR134110	FR16023	BFR340110
FR08124	BFR220110	FR09053	BFR134610	FR09142	BFR230410	FR16024	BRR340110
FR08126	BFR124310	FR09054	BFR135210	FR09143	BFR231410	FR16025	BRR340210
FR08127	BRR123510	FR09056	BFR134310	FR09145	BFR231310	FR16026	BFR343910
FR08128	BFR127110	FR09057	BFR134010	FR09146	BRR136310	FR16027	BRR343010
FR08129	BFR221710	FR09058	BRR131410	FR09148	BFR232310	FR16028	BRR342910
FR08130	BRR123210	FR09059	BFR133910	FR10001	BFR510110	FR16029	BFR340210
FR08132	BFR126810	FR09060	BRR131510	FR10002	BFR511010	FR18001	BFR580410
FR08133	BFR125710	FR09063	BFR134810	FR10003	BFR510210	FR18002	BRR580610
FR08134	BFR129910	FR09065	BFR133610	FR10007	BFR510310	FR18004	BFR580110
FR08136	BFR221810	FR09068	BFR135510	FR10008	BRR510410	FR18005	BRR580310
FR08137	BRR125810	FR09070	BRR131810	FR10009	BRR510310	FR18006	BFR580210
FR08138	BFR220710	FR09073	BFR135610	FR10011	BFR510410	FR18007	BRR580110
FR08139	BFR221110	FR09075	BFR132410	FR10012	BFR510710	FR18008	BFR580510
FR08141	BFR221410	FR09077	BFR135310	FR10013	BRR510810	FR18009	BRR580410
FR08142	BFR121010	FR09079	BFR136210	FR10014	BRR510510	FR18010	BRR580510
FR08152	BRR125310	FR09080	BRR132510	FR10015	BRR510610	FR18011	BFR585250
FR08153	BFR220210	FR09082	BFR133110	FR10017	BFR510610	FR18014	BFR580710
FR08154	BFR410710	FR09090	BRR132610	FR10018	BFR510810	FR18017	BRR580210
FR08155	BFR129710	FR09091	BFR137510	FR10019	BFR511310	FR18018	BFR581210
FR08156	BRR124110	FR09093	BFR136510	FR10020	BRR511310	FR18023	BRR580910
FR08160	BFR127310	FR09094	BRR132810	FR10022	BFR511210	FR19003	BFR540510
FR08162	BFR128110	FR09095	BFR137310	FR10023	BRR511210	FR19004	BFR540410
FR08165	BRR125210	FR09096	BRR133410	FR10025	BFR511410	FR19006	BRR540310
FR08166	BFR123110	FR09097	BFR137210	FR10026	BRR510910	FR19007	BFR540610
FR08167	BRR125610	FR09098	BRR134410	FR10028	BRR511710	FR19008	BRR540510
FR08171	BRR125710	FR09099	BRR133110	FR10029	BRR511110	FR19009	BFR541010
FR08172	BFR222610	FR09101	BFR133310	FR10030	BFR511110	FR19011	BFR540810
FR08173	BRR126410	FR09102	BFR132710	FR10031	BFR510510	FR19013	BRR540810
FR09001	BFR132110	FR09104	BFR133010	FR10032	BRR511010	FR19015	BFR540910
FR09018	BFR130410	FR09109	BFR137110	FR10033	BFR510910	FR19016	BFR541410



Autopar/Fritec	FAG
FR20001	BFR520310
FR20002	BFR350610
FR20003	BFR520710
FR20005	BFR520410
FR20006	BFR520610
FR20007	BFR521510
FR20008	BFR522210
FR20009	BFR522310
FR20017	BRR520410
FR20021	BFR525810
FR20023	BRR520810
FR20026	BFR520110
FR20027	BFR521310
FR20030	BFR521710
FR20031	BFR521610
FR20033	BFR523110
FR20034	BRR521110
FR20038	BFR522110
FR20039	BRR521610
FR20040	BRR521210
FR20041	BRR521310
FR20043	BFR520510
FR20044	BFR523710
FR20048	BFR523410
FR20049	BFR522410
FR20050	BFR523910
FR20051	BRR521910
FR20052	BFR520810
FR20053	BFR524010
FR20054	BFR523610
FR20055	BFR524110
FR20056	BFR524710
FR20057	BFR523210
FR20061	BRR522010
FR20062	BRR521810
FR20063	BFR522410
FR20065	BFR524410
FR20066	BFR525110
FR20067	BFR526510
FR20068	BFR525410
FR20071	BFR526410
FR20072	BFR526310
FR20073	BFR525510
FR20074	BFR523510
FR20075	BFR526110
FR20083	BFR523010
FR21001	BFR380410

Autopar/Fritec	FAG
FR21002	BFR380110
FR21003	BFR380310
FR21006	BFR381010
FR21007	BFR380210
FR21009	BRR389810
FR21010	BRR389710
FR22001	BFR117310
FR22002	BRR114010
FR22003	BRR114110
FR23001	BFR350510
FR23003	BRR350210
FR23008	BFR350210
FR27001	BFR530210
FR27003	BFR530110
FR27005	BRR530210
FR27006	BFR530810
FR27007	BRR530410
FR27008	BFR530310
FR27009	BRR530310
FR27010	BRR530510
FR27011	BFR530710
FR27012	BFR530510
FR27013	BFR530410
FR27015	BFR531310
FR27016	BRR530110
FR27018	BFR531010
FR27021	BFR532210
FR27024	BRR531510
FR27025	BFR531810
FR27028	BRR531010
FR27029	BFR531110
FR27031	BFR531510
FR27032	BFR531710
FR27033	BRR530610
FR27035	BRR531110
FR27036	BRR531310
FR27038	BFR531910
FR27039	BFR537350
FR27040	BFR537450
FR27041	BFR537750
FR27044	BFR532310
FR27046	BRR530810
FR27048	BFR531210
FR28001	BFR370110
FR28002	BFR370510
FR28002	BFR360110
FR28003	BFR370410

Autopar/Fritec	FAG
FR28004	BRR370110
FR28005	BFR371410
FR28006	BRR370210
FR28007	BRR370310
FR28008	BFR370710
FR28009	BRR370510
FR28010	BFR371310
FR28011	BFR370310
FR28012	BRR370610
FR28013	BFR371710
FR28016	BFR370610
FR28017	BFR377010
FR28018	BFR371810
FR28019	BRR373210
FR28020	BFR372210
FR28021	BRR372010
FR28022	BFR371910
FR28024	BFR374510
FR28027	BFR371210
FR28028	BRR370410
FR28030	BFR376110
FR28031	BRR370910
FR28032	BRR374710
FR28034	BRR375010
FR31001	BFR560110
FR31002	BFR137410
FR31003	BFR560410
FR31004	BRR560110
FR31005	BFR560210
FR31006	BRR560310
FT05003	BRD111810
FT05007	BRD111910
FT05010	BRD112010
FT05017	BRD112710
FT05019	BRD111520
FT05023	BRD110910
FT05024	BRD111010
FT05030	BRD110310
FT05031	BRD113510
FT05033	BRD110410
FT08001	BRD123910
FT08003	BRD123610
FT08004	BRD120510
FT08007	BRD122810
FT08010	BRD122710
FT08014	BRD122210
FT08032	BRD124210

Autopar/Fritec	FAG
FT08035	BRD123510
FT08036	BRD120410
FT08038	BRD120110
FT08041	BRD123210
FT09001	BRD132510
FT09006	BRD131910
FT09007	BRD131610
FT09010	BRD134310
FT09012	BRD130310
FT09014	BRD130610
FT09015	BRD131410
FT09019	BRD131210
FT09020	BRD132310
FT09022	BRD132410
FT09026	BRD130810
FT09028	BRD133610
FT09032	BRD134110
FT09033	BRD133410
FT09037	BRD134210
FT09038	BRD133710
FT09039	BRD133210
FT10001	BRD510110
FT10003	BRD510510
FT10005	BRD510210
FT10006	BRD510610
FT11001	BRD110110
FT11002	BRD112610
FT11003	BRD111110
FT19003	BRD540510
FT20003	BRD521310
FT20004	BRD520810
FT20006	BRD522010
FT20007	BRD521810
FT20010	BRD521510
FT20013	BRD350210
FT20014	BRD520710
FT20016	BRD521710
FT20018	BRD521910
FT20019	BRD522210
FT21001	BRD380110
FT21002	BRD380210
FT23001	BRD350110
FT23003	BRD350410
FT27002	BRD530110
FT27004	BRD530410
FT27007	BRD531010
FT27008	BRD530710

Autopar/Fritec	FAG
FT27009	BRD530510
FT27010	BRD530310
FT27011	BRD530910
FT27012	BRD530610
FT28001	BRD370410
FT28002	BFD370110
FT28003	BRD370510
FT28004	BRD370310
FT28005	BRD370210
FT28008	BRD370910
FT28009	BRD371010
FT28010	BRD371210
FT28012	BRD371110
FT28013	BRD370810



EO	FAG
10733	BMC10511
10779	BMC10516
174640	BMC10454
174668	BMC10482
174669	BMC10483
174733	BMC10179
174751	BMC10216
174763	BMC10216
174765	BMC10239
174779	BMC10179
550144	WBC50101
550153	WBC50101
558148	BMC10581
729634	WBC50361
775704	WBC50361
1004131	WBC50108
1006013	WBC50108
1015252	BMC10110
1251281	BMC10316
1369797	BMC10316
1369797	BMC10316
1433956	BMC10354
1573041	BMC10354
1573041	BMC10354
1717334	WBC50333
1721662	WBC50177
1756265	BMC10354
1756265	BMC10354
1782880	WBC50332
1791232	WBC50141
1791233	WBC50140
1795937	WBC50354
1819085	BMC10566
1830639	BMC10573
1894332	WBC50206
2261687	WBC50356
3492467	BMC10106
3492964	BMC10106
3495064	BMC10111
3495399	BMC10106
3495399	BMC10106
3633322	WBC50219
3772241	WBC50128
3772241	WBC50128
3780525	WBC50221
4088898	WBC50123
4088898	WBC50290

EO	FAG
4088899	WBC50289
4088911	WBC50219
4112654	BMC10485
4238199	BMC10453
4238701	WBC50239
4238706	WBC50241
4294152	BMC10467
4294268	BMC10465
4294514	BMC10101
4294578	BMC10453
4294773	BMC10453
4294862	BMC10465
4294865	BMC10101
4294884	BMC10453
4294946	BMC10467
4313056	WBC50263
4313656	WBC50134
4313657	WBC50133
4317001	BMC10324
4317601	BMC10328
4318720	BMC10467
4318720	BMC10467
4342712	BMC10465
4423246	WBC50274
4423852	WBC50273
4423922	WBC50273
4485301	BMC10101
4485312	BMC10101
4486528	WBC50122
4509082	BMC10101
4509602	BMC10465
4509681	BMC10148
4509805	BMC10149
4683264	BMC10162
4695615	BMC10154
4713076	BMC10135
4713076	BMC10135
4721321	BMC10183
4728859	WBC50280
4741834	BMC10135
4741835	BMC10135
4741835	BMC10135
4761602	WBC50284
4761603	WBC50229
4761941	BMC10166
4762164	BMC10135
4762164	BMC10135

EO	FAG
4762296	WBC50239
4762404	WBC50283
4762594	BMC10148
4762604	BMC10149
4764108	BMC10154
4764192	BMC10154
4778453	BMC10156
4779530	BMC10198
4797659	WBC50137
4798157	BMC10184
4882827	BMC10166
4882827	BMC10166
5204338	WBC50239
5252622	BMC10491
5468120	BMC10130
5473036	WBC50221
5473146	WBC50128
7079433	BMC10506
7081424	WBC50291
7089425	WBC50359
7729634	WBC50356
9010515	WBC50368
9193225	BMC10115
10366347	WBC50191
10379247	WBC50192
12350923	WBC50128
13286445	BMC10543
13304907	WBC50207
14066425	BMC10462
15106442	BMC10365
15142479	BMC10325
15183822	BMC10307
15183823	BMC10363
15189238	BMC10340
15221998	BMC10308
15269590	BMC10345
15269947	BMC10267
15795984	BMC10400
15821794	BMC10327
15837546	BMC10364
15844166	BMC10327
15892508	BMC10250
15935842	BMC10402
15935845	BMC10403
15939480	BMC10438
15939484	BMC10439
15939574	BMC10532

EO	FAG
18002063	BMC10130
18002454	BMC10130
18002501	WBC50134
18004793	WBC50209
18004890	WBC50208
18005249	BMC10130
18005259	BMC10140
18005632	WBC50123
18005633	WBC50122
18005894	WBC50238
18006633	BMC10140
18007030	WBC50238
18007971	BMC10475
18007980	WBC50245
18007981	WBC50238
18008068	BMC10455
18008599	WBC50133
18008884	BMC10130
18009377	WBC50246
18009879	BMC10472
18009881	BMC10140
18010087	BMC10460
18010090	BMC10460
18010556	BMC10102
18010748	BMC10455
18011898	WBC50102
18012273	WBC50275
18012303	WBC50245
18012305	WBC50246
18012582	WBC50250
18013417	BMC10460
18013433	BMC10472
18013434	BMC10475
18013434	BMC10475
18013435	BMC10454
18013440	BMC10102
18013954	WBC50260
18013956	WBC50193
18013977	BMC10482
18013978	BMC10483
18014081	WBC50258
18014168	WBC50254
18014171	WBC50257
18014705	BMC10455
18015760	BMC10473
18015812	WBC50268
18017570	WBC50279

EO	FAG
18018168	BMC10163
18018788	WBC50193
18019217	WBC50102
18019217	WBC50194
18020210	WBC50250
18021273	BMC10158
18021277	BMC10165
18021279	BMC10164
18022006	BMC10163
18023761	BMC10182
18026274	BMC10197
18026277	BMC10192
18029418	WBC50275
18029766	WBC50284
18029862	BMC10185
18029868	WBC50143
18029869	WBC50250
18029943	WBC50250
18029949	BMC10170
18029952	BMC10171
18029954	BMC10179
18029955	BMC10178
18029969	BMC10165
18029970	BMC10164
18030312	BMC10140
18030956	BMC10158
18030956	BMC10158
18040236	BMC10216
18040252	BMC10215
18042801	BMC10232
18043278	BMC10216
18044393	BMC10239
18044394	BMC10192
18045119	BMC10235
18047512	BMC10275
18047519	BMC10282
18047524	BMC10268
18047527	BMC10269
18047540	BMC10267
18047594	BMC10171
18047594	BMC10171
18060024	WBC50231
18060026	WBC50229
18060086	BMC10482
18060087	BMC10483
18060090	WBC50258
18060092	WBC50257

EO	FAG
18060136	BMC10474
18060780	BMC10192
18060787	BMC10235
18060788	BMC10239
18060789	BMC10215
18060791	BMC10178
18060792	BMC10179
18060793	BMC10222
19133369	WBC50186
19133370	WBC50187
19151463	BMC10387
19209206	BMC10399
20812023	BMC10394
20845345	BMC10397
20845347	BMC10396
20925765	BMC10567
22407779	BMC10316
22675995	BMC10299
22681430	BMC10308
22681430	BMC10308
22706688	WBC50168
22706785	WBC50191
22707377	BMC10250
22707377	BMC10250
22721986	BMC10326
22725390	BMC10439
22725390	BMC10439
22725391	BMC10438
22725391	BMC10438
25809241	BMC10430
25809242	BMC10429
25832113	WBC50198
25832114	WBC50199
25858330	BMC10401
25872283	BMC10404
25894721	BMC10388
25952633	BMC10405
26692590	WBC50363
42426744	BMC10583
42426745	BMC10583
42473210	WBC50364
52000848	WBC50125
52000849	WBC50124
52006281	BMC10135
52006281	BMC10135
52007933	BMC10135
52007933	BMC10135

EO	FAG
52008281	BMC10135
52008281	BMC10135
52252479	WBC50107
52252480	WBC50106
60809966	WBC50356
60809966	WBC50361
71737949	WBC50356
71737950	WBC50361
71737951	WBC50356
71737951	WBC50361
88970138	WBC50162
88971153	WBC50162
88971205	BMC10248
88971208	BMC10249
89040283	BMC10283
89058902	WBC50177
89059126	WBC50177
89059127	WBC50187
90498300	WBC50101
91172675	BMC10133
91172682	WBC50281
91172683	WBC50282
91174778	BMC10217
91174779	BMC10240
91174800	WBC50147
91174801	WBC50146
91175623	WBC50156
91175624	WBC50157
93172089	BMC10118
93182937	BMC10581
93284550	WBC50210
93289332	BMC10116
93305031	BMC10119
93313891	WBC50295
93332850	BMC10497
93364007	BMC10117
93443532	WBC50111
93443534	BMC10506
93741035	BMC10503
93744982	BMC10442
93744983	BMC10500
93744984	BMC10441
93744985	BMC10440
94566232	BMC10564
94766502	BMC10569
94769766	BMC10572
94770079	WBC50349

EO	FAG
94851529	WBC50315
94851530	WBC50316
94853017	WBC50316
94856390	WBC50315
95018639	WBC50309
95280505	BMC10317
95393156	BMC10583
95393157	BMC10583
95414476	BMC10580
95910900	WBC50350
95984181	BMC10514
96060654	WBC50319
96064815	BMC10133
96064826	WBC50266
96064827	WBC50267
96320670	WBC50114
96418852	BMC10509
96518606	WBC50114
97148431	BMC10576
113611017	BMC10129
113611055	WBC50212
131611057	WBC50211
180206874	WBC50284
191611019	BMC10484
309611051	WBC50230
309611053	WBC50230
331611051	WBC50230
357611019	BMC10134
472006290	BMC10257
861611053	WBC50285
1607138880	WBC50360
3212215883	BMC10511
4110071601	WBC50217
4111071600	WBC50217
4111071601	WBC50217
4111071610	WBC50217
4111076000	WBC50217
4410007201	WBC50216
4410018000	WBC50228
4410022000	WBC50228
4410071200	WBC50218
4412007211	WBC50216
4702804030	BMC10313
4702804040	BMC10314
4702842070	BMC10435
4720102290	BMC10248
4720102290	BMC10248



EO	FAG
4720104150	BMC10434
4720106140	BMC10257
4720106151	BMC10290
4720106430	BMC10318
4720109060	BMC10518
4720109210	BMC10494
4720133340	BMC10257
4720142260	BMC10280
4720142340	BMC10436
4720142380	BMC10435
4720148200	BMC10527
4720152320	BMC10337
4720152330	BMC10338
4720152470	BMC10447
4720708011	BMC10296
4720726020	BMC10505
4755001040	WBC50162
4755002030	WBC50315
4755002100	WBC50172
4755004030	WBC50189
4755008030	WBC50175
4755012030	WBC50316
4755026140	WBC50297
4755026150	WBC50353
4755028020	WBC50318
4755030100	WBC50237
4755030130	WBC50318
4755033020	WBC50183
4755033021	WBC50183
4755035180	WBC50139
4755035280	WBC50262
4755039175	WBC50237
4755039275	WBC50318
4755042020	WBC50162
4757002020	WBC50176
4757006051	WBC50161
4757033020	WBC50161
4845031010	WBC50343
5833002000	WBC50105
5833005500	WBC50334
5833025200	WBC50105
5838005500	WBC50334
5851025000	BMC10247
5851029010	BMC10558
5911044510	BMC10504
6001549707	WBC50327
6001551313	BMC10614

EO	FAG
7701033706	WBC50294
7701035405	WBC50304
7701035406	WBC50303
7701039392	WBC50293
7701043913	WBC50112
7701047838	WBC50348
7701205407	BMC10533
8180175700	WBC50279
8180262740	BMC10197
8180262740	BMC10197
8180299490	BMC10170
8180428020	BMC10222
8180428020	BMC10222
8942335004	WBC50244
8942335005	WBC50244
8942335006	WBC50244
8943134380	BMC10576
8952000848	WBC50125
8952000849	WBC50124
8970382500	BMC10576
8971017080	BMC10576
8973496890	WBC50340
8973496900	WBC50342
8973496920	WBC50341
8973497050	WBC50336
8973497060	WBC50313
8973497070	WBC50314
8973497080	WBC50337
24212317603	BMC10516
113611015AH	BMC10129
113611015BD	BMC10129
113611017A	BMC10129
113611017B	BMC10129
113611023B	BMC10128
113611053A	WBC50213
113611053B	WBC50213
113611055C	WBC50212
113611057B	WBC50211
131611057A	WBC50211
171611019A	BMC10451
171611019B	BMC10451
171611019E	BMC10451
18M201	BMC10460
18M819	BMC10192
1C2Z2140AA	BMC10186
1F2041990A	BMC10189
1F2143990	BMC10191

EO	FAG
1F2Z2140BA	BMC10226
1F2Z2140CA	BMC10227
1F6043990	BMC10190
1H0611053	WBC50285
1H0611053A	WBC50285
1H1611019C	BMC10134
1J0611053	WBC50308
1J1614019	BMC10202
1J1614019E	BMC10367
1J1614019H	BMC10367
1K1614019AF	BMC10426
1K1614019K	BMC10425
1K1614019M	BMC10426
1L5Z2261AA	WBC50153
1L5Z2262AA	WBC50152
1S4Z2004CA	BMC10276
211611021T	BMC10109
211611047D	WBC50233
211611047E	WBC50233
211611047F	WBC50233
2C2Z2140BA	BMC10186
2E0611017B	BMC10547
2E0611017C	BMC10328
2E0611017E	BMC10547
2F2Z2140AA	BMC10272
2H0611019	BMC10549
2H0611053	WBC50312
2L1Z2140AB	BMC10260
2L1Z2140CB	
2L1Z2140BA	BMC10261
2L1Z2140BB	BMC10261
2L1Z2140CB	BMC10260
2L1Z2140DA	BMC10261
2L1Z2140DA	BMC10261
2L5Z2262CA	WBC50235
2L5Z2262DA	WBC50190
2L8Z2140AA	BMC10237
2S652261BA	WBC50291
2S712B507AC	BMC10584
2S712B507BA	BMC10316
331611051A	WBC50230
331611051B	WBC50230
357611019A	BMC10108
357611019B	BMC10161
377611015A	BMC10107
3C1614019D	BMC10427
3C2Z2140DA	BMC10210

EO	FAG
3F1Z2140AA	BMC10181
3L2Z2140BB	BMC10189
43300S04003	WBC50265
43300S04003	WBC50265
43300S0X003	WBC50150
43300S10003	WBC50272
43300S5A003	WBC50169
43300S7A003	WBC50165
43300S7B003	WBC50178
43300S84A02	WBC50271
43300S84A03	WBC50271
43300SCK003	WBC50200
43300SM4A01	WBC50265
43300SM5A01	WBC50272
43300SNAA01	WBC50188
43300SR3003	WBC50265
43300TROA01	WBC50344
43301S04003	WBC50264
43301S04003	WBC50264
43301S0X003	WBC50151
43301S10003	WBC50271
43301S5A003	WBC50170
43301S7A003	WBC50166
43301S7B003	WBC50179
43301S84A02	WBC50272
43301S84A03	WBC50272
43301SCK003	WBC50201
43301SM4A01	WBC50264
43301SM5A01	WBC50271
43301SR3003	WBC50264
4402A1	WBC50303
4402C6	WBC50113
4410000QAA	WBC50121
4410001A00	WBC50104
4410001A02	WBC50104
4410005N01	WBC50103
4410008G10	WBC50251
4410008G11	WBC50278
4410008G13	WBC50278
441000B000	WBC50270
441000Z400	WBC50159
4410017C00	WBC50236
4410017C10	WBC50236
4410017C11	WBC50236
441003HA0A	WBC50310
441003SG0A	WBC50338
441003W0A	WBC50180

EO	FAG
441003W400	WBC50180
441003XE0A	WBC50352
441004B000	WBC50276
441004JA0A	WBC50331
441004KH0B	WBC50369
441004M400	WBC50174
441004M410	WBC50182
441004Z000	WBC50173
4410050C10	WBC50276
4410050C11	WBC50276
4410050C12	WBC50276
4410050C13	WBC50276
441005RB0A	WBC50366
441007B000	WBC50149
441007Z800	WBC50144
441008B400	WBC50278
441008B500	WBC50277
441008Z500	WBC50277
44100B5000	WBC50216
44100B5500	WBC50334
44100D5510	WBC50252
44100D5511	WBC50252
44100D5512	WBC50252
44100ED010	WBC50205
44100ED300	WBC50204
44100ET000	WBC50203
44100F4000	WBC50251
44100G2800	WBC50252
44100G5110	WBC50234
44100H3100	WBC50228
44100M4901	WBC50234
44100N5800	WBC50236
44100S0X003	BMC10218
44100U4000	WBC50228
44100U9200	WBC50236
44100VK00A	WBC50339
44100VN20A	WBC50357
441015RB0A	WBC50367
44101P1801	WBC50228
4509853AA	BMC10149
4509855AA	BMC10149
4560183AA	BMC10546
JA02A 46010	BMC10412
4601000Q0J	BMC10570
4601000Q1C	BMC10614
4601000QAA	BMC10120
4601001G00	BMC10476

EO	FAG
4601004B00	BMC10470
4601004B05	BMC10470
4601004B06	BMC10470
4601004B15	BMC10470
4601004C00	BMC10495
460100B000	BMC10137
460100B001	BMC10137
460100B002	BMC10138
460100B005	BMC10137
460101M320	BMC10169
460101M800	BMC10168
460101Z600	BMC10297
4601025G00	
460102M100	BMC10131
460102Z600	BMC10295
460102Z601	BMC10295
4601031W00	BMC10468
460103SG4B	BMC10575
460103SG5B	BMC10574
4601049L01	BMC10123
460104B000	BMC10167
460104KH1B	BMC10601
460104KH5B	BMC10601
460104Z710	BMC10256
460104Z720	BMC10255
460105M100	BMC10103
460105M200	BMC10254
460105W610	BMC10262
460105W61A	BMC10262
460105W926	BMC10281
4601069Y20	BMC10168
4601072Y14	BMC10131
4601072Y22	BMC10168
4601072Y24	BMC10131
4601072Y74	BMC10131
460107B420	BMC10121
460107S000	BMC10298
460107S020	BMC10294
460107S200	BMC10361
460107S20A	BMC10362
460107Y005	BMC10291
460107Y015	BMC10292
460108B000	BMC10177
460108B500	BMC10177
460108H900	BMC10498
460108J000	BMC10266
460108J100	BMC10356

EO	FAG
46010A05G0	BMC10122
46010C07G0	BMC10495
46010C7000	BMC10468
46010C7001	BMC10468
46010CA000	BMC10443
46010CC22A	BMC10444
46010CK000	BMC10288
46010CK100	BMC10289
46010EA220	BMC10330
46010EA240	BMC10368
46010EA270	BMC10369
46010EA300	BMC10370
46010ET000C	BMC10420
46010F4001	BMC10488
46010F4005	BMC10123
46010J0117	BMC10124
46010P08G0	BMC10468
46010P08G1	BMC10468
46010VK92A	BMC10529
46010VK94B	BMC10561
46010VW001	BMC10125
46010W87G0	BMC10126
46010Y02G1	BMC10131
46010ZJ90A	BMC10534
46010ZS00A	BMC10437
46010ZS10A	BMC10371
4601F8	BMC10105
4601V8	BMC10612
46100S04L71	BMC10605
46100S0X013	BMC10218
46100S0X951	BMC10219
46100S0X952	BMC10219
46100S3VA11	BMC10339
46100S5DA01	BMC10271
46100S5DL01	BMC10253
46100S6MA52	BMC10246
46100S84A52	BMC10536
46100S9AA61	BMC10332
46100S9AA62	BMC10332
46100SCVA51	BMC10522
46100SDAA01	BMC10537
46100SDBA02	BMC10264
46100SH3A01	
46100SH3A02	
46100SH3A03	
46100SH3A04	
46100SJCA51	BMC10339

EO	FAG
46100SJCA51	BMC10339
46100SJCA71	BMC10421
46100SLNA01	BMC10333
46100SNAA01	BMC10335
46100SVAA01	BMC10335
46100SR3033	BMC10487
46100SVAA01	BMC10335
46100SWAA01	BMC10331
46100SZAA01	BMC10372
46100SZAA02	BMC10372
46100T0GA02	BMC10610
46100TA1A01	BMC10373
46100TF0Y01	BMC10526
46100TK4A01	BMC10448
46100TR7A01	BMC10587
46100TX6A02	BMC10587
46100TX6A03	BMC10587
46101SHJ305	BMC10336
46101T0A305	BMC10610
46101TK6305	BMC10423
46101TK8305	BMC10531
4610A008	WBC50298
4625A199	BMC10542
4625A437	BMC10579
4683264AB	BMC10241
4683264AD	BMC10241
472010C070	BMC10366
472010K010	BMC10517
472010K040	BMC10604
472010K410	BMC10611
472010R080	BMC10435
47201BZ550	BMC10603
47201BZ570	BMC10540
4721154AB	BMC10279
4721447AB	BMC10242
4721565AA	BMC10243
475500D010	WBC50292
475500K010	WBC50362
4877270AA	BMC10319
4877805AA	BMC10550
4877805AD	BMC10550
4897210AA	BMC10207
4897210AB	BMC10207
4C2Z2140AA	BMC10285
4F9Z2140BA	BMC10303
4L1Z2140AA	BMC10260
4L3Z2140AA	BMC10273

EO	FAG
4L3Z2140AB	BMC10273
4L3Z2140AC	BMC10273
4R3Z2140AA	BMC10311
5003321AA	BMC10196
5011256AB	BMC10196
5011260AB	BMC10204
5013131AB	BMC10203
5014425AA	WBC50148
5015149AA	BMC10225
5015159AA	BMC10225
5015160AA	BMC10224
5017973AA	BMC10230
5018211AA	WBC50196
5019401AA	BMC10112
5066158AA	WBC50158
5069001AA	BMC10230
5072526AA	BMC10244
5072526AB	BMC10244
5072994AA	BMC10203
5080888AA	BMC10251
5080888AB	BMC10251
5083353AA	BMC10114
5093049AA	BMC10203
5093236AA	WBC50142
5093407AB	BMC10523
5101794AA	BMC10274
5102032AA	BMC10278
5102283AA	BMC10287
5102283AB	BMC10287
5102284AA	BMC10286
5102284AB	BMC10286
5110054G60	BMC10515
5110056B10	BMC10133
5110060A60	BMC10133
5110065JB0	BMC10607
5110067D10	BMC10217
5110067D10	BMC10217
5110067D60	BMC10240
5110067D60	BMC10240
5119354AA	BMC10324
5119355AA	BMC10323
5120085Z20	BMC10514
5120085Z30	BMC10509
5139148AA	BMC10321
5140769AA	BMC10230
5140769AA	BMC10230
5142503AA	BMC10347

EO	FAG
5142507AA	BMC10346
5142652AA	BMC10305
5159101AA	WBC50185
5159992AA	BMC10306
5175093AA	BMC10357
5175093AB	BMC10357
5175103AA	BMC10305
5175103AA	BMC10305
5175701AA	BMC10360
5175732AA	BMC10334
5179892AA	BMC10348
5179926AA	BMC10376
5179926AB	BMC10376
5183198AA	BMC10374
5183200AA	BMC10306
5183200AA	BMC10306
5183871AA	BMC10320
5183886AA	BMC10320
5183886AA	BMC10320
5189175AA	BMC10329
5189227AA	BMC10341
5191305AA	WBC50197
5340156B00	WBC50266
5340156B60	WBC50281
5340165D00	WBC50156
5340167D00	WBC50156
5340256B00	WBC50267
5340256B60	WBC50282
5340265D00	WBC50157
5340267D00	WBC50157
583204B820	WBC50116
583204F100	WBC50302
583300P000	WBC50345
583301G000	WBC50195
583302D000	WBC50320
583304H000	WBC50335
583802D000	WBC50160
584204B820	WBC50115
584204F100	WBC50299
585100X010	BMC10419
585101G000	BMC10343
585101G100	BMC10344
585101R000	BMC10553
585101R100	BMC10563
585104H000	BMC10565
591104F000	BMC10510
5C0611053	WBC50308

EO	FAG
5C0611053A	WBC50308
5C3Z2140FA	BMC10351
5C3Z2140HA	BMC10309
5C3Z2140MA	BMC10212
5F9Z2140CA	BMC10312
5L2Z2140B	BMC10191
5L8Z2K478AA	BMC10301
5L8Z2K478DA	BMC10304
5U1612105A	BMC10228
5Z0611019H	BMC10609
5Z0611019L	BMC10228
5Z0611019L	BMC10609
5Z0611019N	BMC10609
5Z0611019P	BMC10293
5Z0611019P	BMC10609
5Z0611053	WBC50365
5Z1614105E	BMC10609
5Z1614105H	BMC10293
5Z1614105H	BMC10609
68000908AA	BMC10375
68000910AA	BMC10375
68003578AA	WBC50185
68003625AA	BMC10376
68004467AA	BMC10377
68004467AB	BMC10377
68004467AD	BMC10377
68004708AB	BMC10384
68004718AB	BMC10386
68005054AA	BMC10328
68045998AB	BMC10450
68048548AA	BMC10380
68057474AA	BMC10358
68093470AA	BMC10506
68093565AA	WBC50356
68100365AA	BMC10530
68155423AC	BMC10568
68318417AA	WBC50359
68318443AA	WBC50359
6C112K478	BMC10354
6C112K478BE	BMC10354
6C2Z2140AA	BMC10499
6C2Z2140AB	BMC10499
6C3Z2140BF	BMC10310
6C3Z2140DF	BMC10352
6E5Z2140BA	BMC10359
6F2Z2140AA	BMC10432
6F2Z2140CA	BMC10272

EO	FAG
6F2Z2140CA	BMC10272
6L2Z2140B	BMC10502
6L2Z2140BA	BMC10502
6L5Z2140BA	BMC10189
6L8Z2140A	BMC10301
6L8Z2140C	BMC10302
6L8Z2140D	BMC10304
6L8Z2K478AA	BMC10301
6L8Z2K478DA	BMC10304
6N0611053	WBC50163
6Q0611019A	BMC10528
6Q0611019E	BMC10548
6Q0611019F	BMC10609
6Q0611019G	BMC10609
6Q0611019H	BMC10609
6Q0611019J	BMC10609
6Q0611021	BMC10609
6Q0611053B	WBC50311
6Q0611053C	WBC50163
6Q2614105AD	BMC10609
6R1611019	BMC10571
6R1611019A	BMC10571
6R1611019B	BMC10571
6R1611019D	BMC10615
6R1611019E	BMC10571
6R1611019F	BMC10615
6R3Z2140AA	BMC10311
6RU611053C	WBC50347
7A110296	WBC50350
7C3Z2140F	BMC10413
7C3Z2140H	BMC10410
7D0611019	BMC10382
7D0611019B	BMC10382
7L0611019E	BMC10349
7L5Z2140AA	BMC10521
7T1Z2004A	BMC10431
7T1Z2004B	BMC10431
7T4Z2140A	BMC10393
8B5Z2261A	WBC50354
8C3Z2140B	BMC10409
8C3Z2140BB	BMC10409
8C3Z2140J	BMC10409
8E0611021	BMC10263
8L2Z2140B	BMC10502
8L8Z2261AD	WBC50202
8N1614019	BMC10449
8V5Z2261A	WBC50206

EO	FAG
9C2Z2140A	BMC10408
9E5Z2140C	BMC10359
9L3Z2140F	BMC10389
9L8Z2140A	BMC10414
9L8Z2140C	BMC10415
9S4Z2140B	BMC10383
A0004317501	BMC10547
A0004317601	BMC10328
AE5Z2140A	BMC10428
AE8Z2140A	BMC10392
AE8Z2140F	BMC10519
AE8Z2140G	BMC10392
AL3Z2140A	BMC10446
BE8Z2140A	BMC10519
BL3Z2140A	BMC10544
BPYS4340ZA	BMC10355
BPYS4340ZR0B	BMC10355
BPYS4340ZR0B	BMC10355
BV6Z2140A	BMC10545
BV6Z2261A	WBC50355
BW0A26610	WBC50261
C5TZ2261B	WBC50128
CCY94340Z	BMC10424
CCY94340ZA	BMC10424
CCY94340ZR0A	BMC10424
CK4Z2140A	BMC10560
CS692140AA	BMC10573
D1AZ2261A	WBC50127
D1AZ2262A	WBC50126
D2ZZ2261A	WBC50125
D2ZZ2262A	WBC50124
D3OZ2261A	WBC50227
D3OZ2262A	WBC50226
D3TZ2062D	WBC50219
D3TZ2261A	WBC50125
D3TZ2261D	WBC50220
D3TZ2262A	WBC50124
D3ZZ2261A	WBC50125
D3ZZ2262A	WBC50124
D5DZ2261A	WBC50127
D5DZ2262A	WBC50126
D60101AA1B	BMC10391
D60101HK0A	BMC10315
D60101HK1A	BMC10315
D60103XT0A	BMC10562
D6010EL01A	BMC10265
D6010EM30B	BMC10390

EO	FAG
D6010EM31A	BMC10390
D6010EM31B	BMC10390
D6010EM31B	BMC10390
D6010JG80A	BMC10433
D7TZ2140C	BMC10136
D8BZ2261B	WBC50135
D8BZ2262B	WBC50136
D9AZ2261B	WBC50232
D9BZ2140A	BMC10180
DF7126610	WBC50346
DO10078	BMC10504
E0TZ2140B	BMC10452
E0TZ2261A	WBC50227
E0TZ2262A	WBC50226
E1BZ2140A	BMC10457
E2TZ2261B	WBC50215
E2TZ2261C	WBC50127
E2TZ2261D	WBC50227
E2TZ2262B	WBC50214
E2TZ2262C	WBC50126
E2TZ2262D	WBC50226
E3TZ2261B	WBC50240
E43Z2140A	BMC10463
E43Z2261A	WBC50243
E43Z2262A	WBC50242
E4B12261AA	WBC50206
E4DZ2140A	BMC10469
E4TZ2140B	BMC10464
E4TZ2261B	WBC50134
E4TZ2261B	WBC50134
E4TZ2262B	WBC50133
E4TZ2262B	WBC50133
E69Z2261A	WBC50248
E6DZ2261A	WBC50249
E6TZ2140A	BMC10471
E79Z2140A	BMC10477
E79Z2140B	BMC10477
E79Z2140B	BMC10477
E7SZ2140A	BMC10481
E7TZ2140B	BMC10480
E7TZ2140F	BMC10480
E7TZ2261A	WBC50223
E7TZ2262A	WBC50222
E7UZ2140B	BMC10479
E7UZ2140C	BMC10478
E89Z2261A	WBC50248
E92Z2261A	WBC50261

EO	FAG
E93Z2140A	BMC10463
E99Z2261A	WBC50269
E9SZ2261A	WBC50270
E9SZ2261B	WBC50270
E9TZ2261A	WBC50248
E9ZZ2140A	BMC10481
EC0126610B	WBC50155
EC0143400A	BMC10237
EC0143400B	BMC10237
EF924340Z	BMC10302
EG234340Z	BMC10541
F03Z2140A	BMC10463
F0TZ2140A	BMC10489
F0ZZ2140A	BMC10481
F0ZZ2140A	BMC10481
F1CZ2261A	WBC50261
F1DZ2140B	BMC10490
F29Z2261A	WBC50269
F2UZ2261A	WBC50224
F2UZ2262A	WBC50225
F39Z2261A	WBC50287
F3TZ2140A	BMC10480
F3TZ2140B	BMC10480
F3XY2140A	BMC10138
F3XY2140B	BMC10137
F3XY2261A	WBC50270
F4TZ2140A	BMC10479
F4TZ2140A	BMC10480
F4TZ2140E	BMC10478
F4TZ2140F	BMC10146
F4TZ2140F	BMC10501
F4TZ2140G	BMC10478
F4TZ2140H	BMC10145
F4TZ2261A	WBC50223
F4TZ2262A	WBC50222
F57Z2140A	BMC10160
F57Z2140B	BMC10159
F57Z2261A	WBC50138
F58Z2140A	BMC10153
F5RZ2261B	WBC50286
F5UZ2261A	WBC50141
F5UZ2262A	WBC50140
F65Z2140DA	BMC10478
F67Z2140HA	BMC10160
F67Z2140JA	BMC10159
F68Z2140EC	BMC10153
F6TZ2140AA	BMC10104

EO	FAG
F6TZ2140AB	BMC10104
F6TZ2140BA	BMC10173
F6TZ2140EA	BMC10175
F6TZ2140EB	BMC10175
F6TZ2140FA	BMC10174
F6TZ2140FB	BMC10174
F75Z2140GC	BMC10104
F75Z2140GD	BMC10104
F75Z2140HE	BMC10174
F75Z2140JA	BMC10104
F75Z2140KA	BMC10174
F75Z2140NB	BMC10146
F75Z2140NC	BMC10146
F75Z2140NC	BMC10146
F75Z2140PA	BMC10478
F78Z2140HA	BMC10153
F7CZ2140AD	BMC10206
F7CZ2140BD	BMC10205
F7CZ2140CD	BMC10199
F7CZ2140D	BMC10200
F7CZ2140DD	BMC10200
F7DZ2140AA	BMC10181
F7RZ2140BA	BMC10201
F7UZ2140PB	BMC10187
F7UZ2140RB	BMC10186
F81Z2140EA	BMC10211
F87Z2140AA	BMC10190
F87Z2140AC	BMC10190
F87Z2140BA	BMC10191
F87Z2140BC	BMC10191
F87Z2140EA	BMC10189
F87Z2140EB	BMC10189
F87Z2261AA	WBC50130
F87Z2261BA	WBC50145
F88Z2140HA	BMC10153
F88Z2140HB	BMC10153
F88Z2140HB	BMC10153
F8AZ2140AA	BMC10220
F8RZ2261B	WBC50270
F8UZ2140BA	BMC10186
F8UZ2140CA	BMC10187
FOSZ2140A	BMC10490
FOSZ2140A	BMC10490
GJ2126610C	WBC50261
GJ2126610D	WBC50261
GP7A43400B	BMC10359
GP7A43400C	BMC10359

EO	FAG
GP7A43400D	BMC10359
GSYL4340Z	BMC10416
M1S552140AA	BMC10492
M2S652140AA	BMC10493
M5L552261AA	WBC50300
M5L552261AA	WBC50300
M5L552262AA	WBC50301
M5L552262AA	WBC50301
M7N152140AA	BMC10353
M96FB2261BA	WBC50109
M97FB2261BB	WBC50110
MAB392209BA	WBC50333
MB238828	WBC50323
MB238829	WBC50253
MB333468	WBC50307
MB366326	WBC50306
MB500484	WBC50321
MB500485	WBC50322
MB500738	WBC50324
MB500739	WBC50325
MC390375	BMC10576
MN102377	BMC10445
MN102440	BMC10496
MN102441	BMC10513
MN113522	BMC10512
MR129595	WBC50181
MR289188	BMC10512
MR407141	WBC50167
MR527470	BMC10538
MR569685	BMC10300
TD114340ZA	BMC10418
UB3926610	WBC50255
UB3926710	WBC50256
UB3926710C	WBC50256
XC2Z2140DA	BMC10210
XF2Z2140DA	BMC10226
XF2Z2140DA	BMC10226
XF2Z2140EA	BMC10227
XF5Z2261A	WBC50149
XS512261A	WBC50108
YC2Z2140DA	BMC10187
YC2Z2140DB	BMC10187
YL2Z2140AA	BMC10535
YL3Z2140AA	BMC10350
YL8Z2140AA	BMC10237
YL8Z2261BA	WBC50155
YS4Z2004AA	BMC10231

EO	FAG
YS4Z2004BA	BMC10236
YS4Z2004BB	BMC10236
YS4Z2261AA	WBC50154
YS4Z2261AB	WBC50154
YS4Z2261BB	WBC50247
ZZC243990	BMC10302
ZZC243990A	BMC10302
ZZC343990	BMC10304
ZZD143990	BMC10414
ZZL026610	WBC50248
ZZL026610	WBC50269
ZZL026610A	WBC50269
ZZL043400	BMC10489
ZZM126610	WBC50138
ZZM141990	BMC10489
ZZM226610	WBC50240
ZZM443990	BMC10159
ZZM443990	BMC10160
ZZM543990	BMC10159
ZZM743990	BMC10160
ZZM843990	BMC10159
ZZP043400	BMC10190
ZZP043400A	BMC10190
ZZP126610	WBC50145
ZZP143400	BMC10191
Raybestos	FAG
MC36272	BMC10128
MC36275	BMC10129
MC36306	BMC10130
MC390006	BMC10131
MC390056	BMC10133
MC390071	BMC10135
MC39011	BMC10136
MC390115	BMC10137
MC390116	BMC10138
MC39016	BMC10140
MC390182	BMC10145
MC390183	BMC10146
MC390204	BMC10148
MC390213	BMC10149
MC390234	BMC10103
MC390248	BMC10153
MC390251	BMC10154
MC390257	BMC10156
MC390259	BMC10158
MC390268	BMC10159
MC390269	BMC10160

Raybestos	FAG
MC390271	BMC10161
MC390275	BMC10162
MC390277	BMC10163
MC390278	BMC10164
MC390279	BMC10165
MC390303	BMC10166
MC390317	BMC10167
MC390318	BMC10168
MC390319	BMC10169
MC390320	BMC10170
MC390321	BMC10171
MC390336	BMC10104
MC390337	BMC10173
MC390338	BMC10174
MC390339	BMC10175
MC390343	BMC10177
MC390363	BMC10178
MC390364	BMC10179
MC39037	BMC10180
MC390370	BMC10181
MC390371	BMC10182
MC390377	BMC10183
MC390378	BMC10184
MC390386	BMC10185
MC390392	BMC10186
MC390394	BMC10187
MC390398	BMC10189
MC390399	BMC10190
MC390400	BMC10191
MC390401	BMC10192
MC390426	BMC10196
MC390427	BMC10197
MC390440	BMC10198
MC390447	BMC10199
MC390449	BMC10200
MC390463	BMC10201
MC390466	BMC10121
MC390500	BMC10202
MC390508	BMC10203
MC390511	BMC10204
MC390514	BMC10205
MC390515	BMC10206
MC390516	BMC10207
MC390526	BMC10210
MC390530	BMC10211
MC390531	BMC10212
MC390541	BMC10215

Raybestos	FAG
MC390542	BMC10216
MC390546	BMC10217
MC390550	BMC10605
MC390556	BMC10219
MC390569	BMC10220
MC390571	BMC10222
MC390577	BMC10224
MC390579	BMC10225
MC390581	BMC10226
MC390582	BMC10227
MC390638	BMC10230
MC390643	BMC10231
MC390646	BMC10232
MC390676	BMC10235
MC390678	BMC10236
MC390690	BMC10237
MC390697	BMC10239
MC390707	BMC10240
MC390708	BMC10241
MC390709	BMC10242
MC390710	BMC10243
MC390712	BMC10244
MC390720	BMC10112
MC390721	BMC10246
MC390724	BMC10247
MC390734	BMC10248
MC390735	BMC10249
MC390739	BMC10250
MC390742	BMC10251
MC390746	BMC10253
MC390747	BMC10254
MC390748	BMC10255
MC390749	BMC10256
MC390752	BMC10257
MC390762	BMC10260
MC390774	BMC10262
MC390778	BMC10263
MC390781	BMC10512
MC390784	BMC10264
MC390792	BMC10522
MC390800	BMC10266
MC390804	BMC10267
MC390805	BMC10268
MC390806	BMC10269
MC390808	BMC10271
MC390810	BMC10272
MC390811	BMC10273

Raybestos	FAG
MC390816	BMC10274
MC390818	BMC10275
MC390819	BMC10276
MC390821	BMC10278
MC390833	BMC10280
MC390835	BMC10281
MC390843	BMC10282
MC390845	BMC10283
MC390849	BMC10285
MC390852	BMC10286
MC390853	BMC10287
MC390854	BMC10288
MC390855	BMC10289
MC390857	BMC10290
MC390858	BMC10291
MC390859	BMC10292
MC390867	BMC10295
MC390870	BMC10296
MC390885	BMC10299
MC390886	BMC10300
MC390909	BMC10301
MC390919	BMC10303
MC390922	BMC10304
MC390926	BMC10305
MC390927	BMC10306
MC390930	BMC10307
MC390933	BMC10308
MC390956	BMC10309
MC390957	BMC10310
MC390960	BMC10312
MC390964	BMC10313
MC390965	BMC10314
MC390970	BMC10318
MC390975	BMC10319
MC390976	BMC10320
MC390977	BMC10321
MC390979	BMC10323
MC390980	BMC10324
MC390985	BMC10326
MC390986	BMC10327
MC390988	BMC10328
MC390991	BMC10329
MC390996	BMC10330
MC390997	BMC10331
MC390998	BMC10332
MC391000	BMC10333
MC391001	BMC10334

Raybestos	FAG
MC391002	BMC10335
MC391004	BMC10336
MC391005	BMC10338
MC391006	BMC10337
MC391007	BMC10339
MC391010	BMC10340
MC391022	BMC10343
MC391024	BMC10344
MC391026	BMC10345
MC391031	BMC10346
MC391032	BMC10347
MC391041	BMC10350
MC391042	BMC10351
MC391043	BMC10352
MC391049	BMC10355
MC391066	BMC10357
MC391068	BMC10358
MC391069	BMC10359
MC391071	BMC10360
MC391072	BMC10362
MC391080	BMC10363
MC391081	BMC10364
MC391082	BMC10365
MC391085	BMC10366
MC391092	BMC10367
MC391096	BMC10368
MC391097	BMC10369
MC391098	BMC10370
MC391100	BMC10372
MC391101	BMC10373
MC391110	BMC10374
MC391121	BMC10375
MC391122	BMC10376
MC391123	BMC10377
MC391130	BMC10382
MC391133	BMC10502
MC391137	BMC10383
MC391138	BMC10527
MC391142	BMC10384
MC391144	BMC10386
MC391145	BMC10387
MC391147	BMC10388
MC391150	BMC10389
MC391156	BMC10390
MC391158	BMC10391
MC391160	BMC10392
MC391162	BMC10393

Raybestos	FAG
MC391165	BMC10394
MC391169	BMC10396
MC391170	BMC10500
MC391172	BMC10397
MC391180	BMC10400
MC391181	BMC10401
MC391183	BMC10402
MC391184	BMC10403
MC391185	BMC10404
MC391186	BMC10405
MC391191	BMC10408
MC391195	BMC10409
MC391197	BMC10410
MC391200	BMC10413
MC391203	BMC10414
MC391204	BMC10415
MC391207	BMC10416
MC391214	BMC10418
MC391225	BMC10421
MC391228	BMC10423
MC391230	BMC10424
MC391231	BMC10425
MC391232	BMC10426
MC391233	BMC10427
MC391237	BMC10428
MC391252	BMC10429
MC391253	BMC10430
MC391254	BMC10431
MC391255	BMC10432
MC391267	BMC10433
MC391271	BMC10530
MC391295	BMC10434
MC391296	BMC10435
MC391299	BMC10436
MC391303	BMC10437
MC391304	BMC10265
MC391307	BMC10420
MC391310	BMC10412
MC391328	BMC10438
MC391329	BMC10439
MC391331	BMC10440
MC391332	BMC10441
MC391333	BMC10442
MC391341	BMC10443
MC391343	BMC10444
MC391344	BMC10445
MC391358	BMC10532

Raybestos	FAG
MC391359	BMC10446
MC391376	BMC10447
MC391378	BMC10448
MC391384	BMC10449
MC391385	BMC10450
MC391387	BMC10545
MC39147	BMC10451
MC391471	BMC10610
MC39150	BMC10126
MC39173	BMC10452
MC39178	BMC10453
MC39223	BMC10454
MC39228	BMC10124
MC39324	BMC10455
MC39350	BMC10457
MC39382	BMC10460
MC39435	BMC10462
MC39443	BMC10463
MC39445	BMC10464
MC39451	BMC10465
MC39476	BMC10467
MC39509	BMC10468
MC39531	BMC10469
MC39555	BMC10122
MC39555	BMC10470
MC39567	BMC10471
MC39571	BMC10472
MC39578	BMC10102
MC39583	BMC10473
MC39585	BMC10474
MC39589	BMC10475
MC39592	BMC10123
MC39593	BMC10476
MC39628	BMC10477
MC39634	BMC10478
MC39635	BMC10479
MC39636	BMC10480
MC39637	BMC10481
MC39646	BMC10482
MC39649	BMC10483
MC39655	BMC10484
MC39712	BMC10485
MC39736	BMC10101
MC39953	BMC10489
MC39958	BMC10490
MC39981	BMC10491
MIS55214	BMC10492



Raybestos	FAG
WC13387	WBC50122
WC13388	WBC50123
WC17507	WBC50124
WC17508	WBC50125
WC17509	WBC50126
WC17510	WBC50127
WC24489	WBC50128
WC36057	WBC50133
WC36058	WBC50134
WC36076	WBC50135
WC36077	WBC50136
WC370027	WBC50137
WC370031	WBC50138
WC370032	WBC50139
WC370042	WBC50140
WC370043	WBC50141
WC370051	WBC50142
WC370055	WBC50143
WC370060	WBC50144
WC370061	WBC50145
WC370073	WBC50146
WC370074	WBC50147
WC370081	WBC50148
WC370083	WBC50149
WC370087	WBC50150
WC370088	WBC50151
WC370091	WBC50152
WC370092	WBC50153
WC370093	WBC50154
WC370094	WBC50155
WC370095	WBC50281
WC370096	WBC50282
WC370103	WBC50210
WC370105	WBC50158
WC370106	WBC50159
WC370111	WBC50161
WC370112	WBC50162
WC370113	WBC50311
WC370115	WBC50308
WC370121	WBC50355
WC370123	WBC50165
WC370127	WBC50166
WC370129	WBC50167
WC370130	WBC50168
WC370131	WBC50169
WC370132	WBC50170
WC370139	WBC50172

Raybestos	FAG
WC370141	WBC50173
WC370142	WBC50174
WC370143	WBC50175
WC370143	WBC50297
WC370146	WBC50176
WC370148	WBC50177
WC370149	WBC50178
WC370152	WBC50179
WC370154	WBC50180
WC370155	WBC50181
WC370157	WBC50182
WC370174	WBC50183
WC370177	WBC50185
WC370180	WBC50186
WC370181	WBC50187
WC370182	WBC50188
WC370183	WBC50189
WC370185	WBC50190
WC370186	WBC50191
WC370187	WBC50192
WC370189	WBC50193
WC370190	WBC50194
WC370194	WBC50195
WC370195	WBC50196
WC370197	WBC50197
WC370200	WBC50198
WC370201	WBC50199
WC370211	WBC50202
WC370212	WBC50203
WC370213	WBC50204
WC370214	WBC50205
WC370225	WBC50206
WC370226	WBC50207
WC370232	WBC50344
WC370239	WBC50337
WC370240	WBC50313
WC370241	WBC50336
WC370247	WBC50314
WC370253	WBC50345
WC370254	WBC50310
WC370255	WBC50338
WC37048	WBC50208
WC37080	WBC50209
WC37109	WBC50211
WC37110	WBC50212
WC37111	WBC50213
WC37132	WBC50214

Raybestos	FAG
WC37133	WBC50215
WC37208	WBC50216
WC37209	WBC50217
WC37210	WBC50218
WC37218	WBC50219
WC37219	WBC50220
WC37235	WBC50221
WC37250	WBC50223
WC37251	WBC50222
WC37262	WBC50224
WC37263	WBC50225
WC37267	WBC50226
WC37268	WBC50227
WC37274	WBC50228
WC37290	WBC50229
WC37332	WBC50230
WC37337	WBC50231
WC37343	WBC50232
WC37349	WBC50233
WC37358	WBC50234
WC37400	WBC50235
WC37407	WBC50236
WC37459	WBC50237
WC37531	WBC50238
WC37564	WBC50239
WC37574	WBC50240
WC37590	WBC50241
WC37591	WBC50242
WC37592	WBC50243
WC37599	WBC50244
WC37601	WBC50321
WC37602	WBC50322
WC37625	WBC50245
WC37637	WBC50316
WC37643	WBC50275
WC37644	WBC50246
WC37646	WBC50315
WC37660	WBC50247
WC37663	WBC50248
WC37668	WBC50249
WC37677	WBC50250
WC37684	WBC50251
WC37693	WBC50252
WC37708	WBC50323
WC37709	WBC50253
WC37710	WBC50324
WC37711	WBC50325

Raybestos	FAG
WC37750	WBC50254
WC37751	WBC50256
WC37752	WBC50255
WC37778	WBC50257
WC37781	WBC50258
WC37784	WBC50260
WC37787	WBC50261
WC37841	WBC50262
WC37844	WBC50263
WC37846	WBC50265
WC37847	WBC50264
WC37850	WBC50319
WC37852	WBC50266
WC37853	WBC50267
WC37854	WBC50268
WC37855	WBC50102
WC37856	WBC50269
WC37857	WBC50270
WC37858	WBC50271
WC37859	WBC50272
WC37862	WBC50130
WC37863	WBC50273
WC37864	WBC50274
WC37866	WBC50346
WC37869	WBC50276
WC37870	WBC50103
WC37871	WBC50277
WC37872	WBC50278
WC37967	WBC50279
WC37970	WBC50280
WC37984	WBC50283
WC37985	WBC50284
WC37986	WBC50285
WC37997	WBC50286
WC37999	WBC50287
WC9025	WBC50289
WC9026	WBC50290
Lusac	FAG
844	WBC50101
13387	WBC50122
13388	WBC50123
17507	WBC50124
17508	WBC50125
18984	WBC50219
18985	WBC50220
35325	WBC50133
35326	WBC50134

Lusac	FAG
37208	WBC50216
37209	WBC50217
37250	WBC50223
37251	WBC50222
37274	WBC50228
37358	WBC50234
37376	WBC50160
37407	WBC50236
37420	WBC50318
37459	WBC50237
37574	WBC50240
37576	WBC50163
37599	WBC50244
37601	WBC50321
37602	WBC50322
37625	WBC50245
37637	WBC50316
37644	WBC50246
37646	WBC50315
37663	WBC50248
37684	WBC50251
37693	WBC50252
37708	WBC50323
37709	WBC50253
37710	WBC50324
37711	WBC50325
37751	WBC50256
37752	WBC50255
37782	WBC50135
37783	WBC50136
37787	WBC50261
37841	WBC50262
37844	WBC50263
37846	WBC50265
37847	WBC50264
37850	WBC50319
37852	WBC50266
37853	WBC50267
37854	WBC50268
37855	WBC50102
37856	WBC50269
37857	WBC50270
37858	WBC50271
37859	WBC50272
37862	WBC50130
37863	WBC50273
37864	WBC50274

Lusac	FAG
37866	WBC50346
37869	WBC50276
37870	WBC50103
37871	WBC50277
37872	WBC50278
37967	WBC50279
37970	WBC50280
37975	WBC50281
37976	WBC50282
37984	WBC50283
37985	WBC50284
37986	WBC50285
37997	WBC50286
37999	WBC50287
39509	BMC10468
39555	BMC10470
39567	BMC10471
39571	BMC10472
39592	BMC10123
39593	BMC10476
39635	BMC10479
39646	BMC10482
39649	BMC10483
39736	BMC10101
39780	BMC10487
39953	BMC10489
39981	BMC10491
51081	WBC50208
51088	WBC50209
57146	WBC50214
57147	WBC50215
59240	WBC50126
59241	WBC50127
78974	WBC50289
78975	WBC50290
79767	WBC50229
90547	BMC10128
90549	WBC50211
90550	WBC50212
93356	WBC50213
96387	WBC50233
96399	WBC50230
96409	BMC10451
96415	BMC10129
97934	BMC10136
98895	BMC10453
99084	BMC10180

Lusac	FAG
101253	BMC10140
101254	BMC10130
101604	WBC50235
102421	BMC10452
104384	WBC50238
104464	BMC10455
104466	BMC10475
104516	BMC10454
105808	BMC10457
106315	WBC50221
107475	WBC50241
107476	WBC50239
108106	WBC50243
108107	WBC50242
108134	BMC10465
108145	BMC10462
108151	BMC10463
108168	BMC10467
110887	BMC10102
110919	BMC10464
110983	BMC10484
112311	BMC10469
112341	WBC50250
112365	WBC50249
113757	WBC50224
113758	WBC50225
114075	BMC10477
114079	BMC10480
114190	BMC10473
114192	BMC10474
116263	WBC50260
116359	WBC50258
116366	WBC50257
116384	WBC50254
116403	BMC10460
117345	WBC50104
117583	BMC10481
120369	BMC10478
122572	BMC10490
370027	WBC50137
370031	WBC50138
370032	WBC50139
370042	WBC50140
370043	WBC50141
370051	WBC50142
370055	WBC50143
370061	WBC50145

Lusac	FAG
370073	WBC50146
370074	WBC50147
370081	WBC50148
370083	WBC50149
370087	WBC50150
370088	WBC50151
370091	WBC50152
370092	WBC50153
370093	WBC50154
370094	WBC50155
370103	WBC50210
370105	WBC50158
370106	WBC50159
370112	WBC50162
370113	WBC50311
370115	WBC50308
370121	WBC50247
370123	WBC50165
370127	WBC50166
370129	WBC50167
370130	WBC50168
370131	WBC50169
370132	WBC50170
370139	WBC50172
370142	WBC50174
370143	WBC50175
370143	WBC50297
370146	WBC50176
370148	WBC50177
370149	WBC50178
370152	WBC50179
370154	WBC50180
370155	WBC50181
370157	WBC50182
370177	WBC50185
370180	WBC50186
370181	WBC50187
370182	WBC50188
370183	WBC50189
370185	WBC50190
370186	WBC50191
370187	WBC50192
370189	WBC50193
370190	WBC50194
370194	WBC50195
370195	WBC50196
370197	WBC50197



Lusac	FAG
370200	WBC50198
370201	WBC50199
370205	WBC50200
370206	WBC50201
370211	WBC50202
370212	WBC50203
370213	WBC50204
370214	WBC50205
370225	WBC50206
370226	WBC50207
370231	WBC50355
370239	WBC50337
370240	WBC50313
370241	WBC50314
370247	WBC50336
370253	WBC50345
370254	WBC50310
370255	WBC50338
370277	WBC50367
370278	WBC50366
370382	WBC50106
370384	WBC50107
390006	BMC10131
390007	BMC10356
390056	BMC10133
390071	BMC10135
390115	BMC10137
390116	BMC10138
390161	BMC10576
390182	BMC10145
390183	BMC10146
390183	BMC10501
390204	BMC10148
390213	BMC10149
390234	BMC10103
390248	BMC10153
390251	BMC10154
390257	BMC10156
390259	BMC10158
390268	BMC10159
390269	BMC10160
390271	BMC10161
390275	BMC10162
390277	BMC10163
390278	BMC10164
390279	BMC10165
390303	BMC10166

Lusac	FAG
390317	BMC10167
390318	BMC10168
390319	BMC10169
390320	BMC10170
390321	BMC10171
390336	BMC10104
390337	BMC10173
390338	BMC10174
390339	BMC10175
390343	BMC10177
390363	BMC10178
390364	BMC10179
390370	BMC10181
390371	BMC10182
390377	BMC10183
390378	BMC10184
390386	BMC10185
390392	BMC10186
390394	BMC10187
390398	BMC10189
390399	BMC10190
390400	BMC10191
390401	BMC10192
390426	BMC10196
390427	BMC10197
390440	BMC10198
390447	BMC10199
390449	BMC10200
390463	BMC10201
390500	BMC10202
390508	BMC10203
390514	BMC10205
390515	BMC10206
390516	BMC10207
390526	BMC10210
390530	BMC10211
390531	BMC10212
390541	BMC10215
390542	BMC10216
390546	BMC10217
390550	BMC10605
390551	BMC10218
390556	BMC10219
390569	BMC10220
390571	BMC10222
390577	BMC10224
390579	BMC10225

Lusac	FAG
390581	BMC10226
390582	BMC10227
390638	BMC10230
390643	BMC10231
390646	BMC10232
390676	BMC10235
390678	BMC10236
390690	BMC10237
390697	BMC10239
390707	BMC10240
390708	BMC10241
390709	BMC10242
390710	BMC10243
390712	BMC10244
390721	BMC10246
390724	BMC10247
390734	BMC10248
390735	BMC10249
390739	BMC10250
390742	BMC10251
390746	BMC10253
390747	BMC10254
390748	BMC10255
390749	BMC10256
390762	BMC10260
390763	BMC10261
390774	BMC10262
390778	BMC10263
390781	BMC10512
390784	BMC10264
390792	BMC10537
390800	BMC10266
390804	BMC10267
390805	BMC10268
390806	BMC10269
390808	BMC10271
390810	BMC10272
390811	BMC10273
390816	BMC10274
390818	BMC10275
390819	BMC10276
390821	BMC10278
390823	BMC10279
390833	BMC10280
390835	BMC10281
390843	BMC10282
390845	BMC10283

Lusac	FAG
390849	BMC10285
390852	BMC10286
390853	BMC10287
390854	BMC10288
390855	BMC10289
390857	BMC10290
390858	BMC10291
390859	BMC10292
390866	BMC10294
390867	BMC10295
390870	BMC10296
390875	BMC10297
390879	BMC10298
390885	BMC10299
390886	BMC10300
390898	BMC10257
390909	BMC10301
390910	BMC10302
390919	BMC10303
390922	BMC10304
390926	BMC10305
390927	BMC10306
390930	BMC10307
390931	BMC10108
390933	BMC10308
390956	BMC10309
390957	BMC10310
390960	BMC10312
390964	BMC10313
390965	BMC10314
390970	BMC10318
390975	BMC10319
390976	BMC10320
390977	BMC10321
390979	BMC10323
390980	BMC10324
390983	BMC10325
390985	BMC10326
390986	BMC10327
390988	BMC10328
390991	BMC10329
390996	BMC10330
390997	BMC10331
390998	BMC10332
391000	BMC10333
391001	BMC10334
391002	BMC10335

Lusac	FAG
391004	BMC10336
391005	BMC10338
391006	BMC10337
391007	BMC10339
391010	BMC10340
391012	BMC10341
391022	BMC10343
391024	BMC10344
391026	BMC10345
391031	BMC10346
391032	BMC10347
391033	BMC10348
391036	BMC10349
391041	BMC10350
391042	BMC10351
391043	BMC10352
391049	BMC10355
391066	BMC10357
391068	BMC10358
391069	BMC10359
391071	BMC10360
391072	BMC10362
391080	BMC10363
391081	BMC10364
391082	BMC10365
391085	BMC10366
391092	BMC10367
391096	BMC10368
391097	BMC10369
391098	BMC10370
391099	BMC10371
391100	BMC10372
391101	BMC10373
391103	BMC10550
391110	BMC10374
391121	BMC10375
391122	BMC10376
391123	BMC10377
391127	BMC10380
391130	BMC10382
391133	BMC10502
391137	BMC10383
391138	BMC10527
391142	BMC10384
391144	BMC10386
391145	BMC10387
391147	BMC10388

Lusac	FAG
391150	BMC10389
391156	BMC10390
391158	BMC10391
391160	BMC10392
391162	BMC10393
391165	BMC10394
391169	BMC10396
391170	BMC10500
391171	BMC10581
391172	BMC10397
391179	BMC10399
391180	BMC10400
391181	BMC10401
391183	BMC10402
391184	BMC10403
391185	BMC10404
391186	BMC10405
391191	BMC10408
391195	BMC10409
391197	BMC10410
391200	BMC10413
391203	BMC10414
391204	BMC10415
391207	BMC10416
391214	BMC10418
391215	BMC10607
391225	BMC10421
391228	BMC10423
391231	BMC10425
391232	BMC10426
391233	BMC10427
391237	BMC10428
391252	BMC10429
391253	BMC10430
391254	BMC10431
391255	BMC10432
391267	BMC10433
391271	BMC10530
391295	BMC10434
391296	BMC10435
391299	BMC10436
391303	BMC10437
391304	BMC10265
391307	BMC10420
391310	BMC10412
391328	BMC10438
391329	BMC10439

Lusac	FAG
391331	BMC10440
391332	BMC10441
391333	BMC10442
391341	BMC10443
391343	BMC10444
391344	BMC10445
391358	BMC10532
391359	BMC10446
391376	BMC10447
391378	BMC10448
391384	BMC10449
391385	BMC10450
391387	BMC10545
391403	BMC10534
391420	BMC10315
391425	BMC10563
391462	BMC10587
391471	BMC10610
391474	BMC10574
391477	BMC10575
391526	BMC10580
3495064	BMC10111
3700900	WBC50109
3700904	WBC50110
3700908	WBC50111
3700912	WBC50112
3700913	WBC50113
3700914	WBC50114
3700916	WBC50295
3700917	WBC50302
3700920	WBC50299
3700921	WBC50335
3700922	WBC50334
3700923	WBC50309
3700925	WBC50298
3700928	WBC50294
3700929	WBC50293
5011260	BMC10204
5019401	BMC10112
5083353	BMC10114
9193225	BMC10115
37009016	WBC50115
37009017	WBC50116
37009018	WBC50300
37009019	WBC50301
39009900	BMC10504
39009902	BMC10116

Lusac	FAG
39009903	BMC10117
39009904	BMC10110
39009906	BMC10493
39009907	BMC10497
39009909	BMC10505
39009910	BMC10125
39009911	BMC10228
39009912	BMC10293
39009913	BMC10529
39009914	BMC10503
39009915	BMC10498
39009917	BMC10354
39009918	BMC10353
39009919	BMC10317
39009923	BMC10584
39009924	BMC10583
39009926	BMC10419
39009932	BMC10603
93172089	BMC10118
93305031	BMC10119
370018RL	WBC50105
37030405MX	WBC50349
37030414MX	WBC50368
37030416MX	WBC50350
37030417MX	WBC50364
37060409MX	WBC50359
37090403MX	WBC50333
37090404MX	WBC50332
37090413MX	WBC50354
37090426MX	WBC50108
37120522MX	WBC50342
37120524MX	WBC50341
37120623MX	WBC50340
37210402MX	WBC50357
37210407MX	WBC50331
37210412MX	WBC50352
37240406MX	WBC50348
37240408MX	WBC50343
37240425MX	WBC50327
37280519MX	WBC50306
37280620MX	WBC50307
37300401MX	WBC50347
37300421MX	WBC50312
37350411MX	WBC50361
37440410MX	WBC50360
39030135MX	BMC10509
390700RL	BMC10105



Lusac	FAG
390801RL	BMC10106
39090136MX	BMC10511
390901RL	BMC10107
390951RL	BMC10109
39100140MX	BMC10526
39210127MX	BMC10562
39210138MX	BMC10495
39240101MX	BMC10614
39240136MX	BMC10516
39270133MX	BMC10515
39300121MX	BMC10571
39300130MX	BMC10548
39320134MX	BMC10510
39520131MX	BMC10494
4410000Q	WBC50121
441004Z0	WBC50173
441007Z0	WBC50144
4601000Q	BMC10120
460108B6	BMC10121
46010A05	BMC10122
46010F40	BMC10488
46010J01	BMC10124
46010W87	BMC10126
98896-A	BMC10485
MIS55214	BMC10492
Centric	FAG
130.33001	BMC10349
130.33116	BMC10263
130.33124	BMC10425
130.33133	BMC10427
130.33204	BMC10109
130.33401	BMC10451
130.33405	BMC10134
130.33405	BMC10484
130.33408	BMC10108
130.33408	BMC10161
130.33417	BMC10202
130.33419	BMC10382
130.33421	BMC10449
130.33425	BMC10367
130.33426	BMC10426
130.33501	BMC10128
130.33502	BMC10129
130.35500	BMC10324
130.35501	BMC10323
130.35502	BMC10328
130.35505	BMC10547

Centric	FAG
130.40009	BMC10487
130.40026	BMC10605
130.40032	BMC10536
130.40044	BMC10218
130.40045	BMC10219
130.40048	BMC10253
130.40049	BMC10271
130.40051	BMC10522
130.40052	BMC10246
130.40055	BMC10537
130.40056	BMC10264
130.40058	BMC10339
130.40060	BMC10336
130.40061	BMC10332
130.40064	BMC10335
130.40067	BMC10333
130.40071	BMC10331
130.40072	BMC10373
130.40073	BMC10372
130.40074	BMC10448
130.40076	BMC10423
130.40078	BMC10421
130.40079	BMC10587
130.40080	BMC10531
130.40084	BMC10610
130.42008	BMC10288
130.42009	BMC10289
130.42206	BMC10470
130.42213	BMC10167
130.42214	BMC10168
130.42216	BMC10131
130.42217	BMC10169
130.42218	BMC10103
130.42218	BMC10256
130.42219	BMC10254
130.42219	BMC10255
130.42221	BMC10420
130.42222	BMC10534
130.42224	BMC10574
130.42225	BMC10575
130.42307	BMC10468
130.42310	BMC10123
130.42310	BMC10488
130.42311	BMC10476
130.42318	BMC10177
130.42321	BMC10121
130.42323	BMC10262

Centric	FAG
130.42325	BMC10297
130.42327	BMC10295
130.42328	BMC10281
130.42330	BMC10371
130.42331	BMC10368
130.42332	BMC10370
130.42333	BMC10369
130.42334	BMC10330
130.42336	BMC10437
130.42412	BMC10266
130.42413	BMC10356
130.42414	BMC10291
130.42415	BMC10292
130.42418	BMC10412
130.42800	BMC10443
130.42804	BMC10444
130.42806	BMC10390
130.42811	BMC10433
130.42814	BMC10391
130.42815	BMC10265
130.42823	BMC10315
130.42900	BMC10362
130.42901	BMC10294
130.42902	BMC10298
130.42905	BMC10361
130.43012	BMC10576
130.44034	BMC10257
130.44036	BMC10290
130.44047	BMC10318
130.44120	BMC10248
130.44120	BMC10518
130.44121	BMC10249
130.44125	BMC10337
130.44126	BMC10338
130.44127	BMC10539
130.44515	BMC10447
130.44742	BMC10314
130.44743	BMC10313
130.44744	BMC10366
130.44745	BMC10434
130.44823	BMC10527
130.44825	BMC10296
130.44918	BMC10280
130.44919	BMC10436
130.44920	BMC10435
130.45121	BMC10418
130.45422	BMC10355

Centric	FAG
130.45424	BMC10424
130.45427	BMC10416
130.46018	BMC10300
130.46030	BMC10445
130.46501	WBC50346
130.46523	BMC10538
130.46525	BMC10512
130.46535	BMC10579
130.48005	BMC10133
130.48017	BMC10217
130.48018	BMC10240
130.48024	BMC10515
130.48025	BMC10607
130.48032	BMC10509
130.48033	BMC10514
130.49020	BMC10441
130.49021	BMC10440
130.49022	BMC10500
130.49023	BMC10442
130.51017	BMC10247
130.51040	BMC10344
130.51063	BMC10563
130.58003	BMC10204
130.58004	BMC10244
130.58007	BMC10341
130.58008	BMC10334
130.58009	BMC10546
130.61001	BMC10481
130.61004	BMC10463
130.61031	BMC10180
130.61042	BMC10457
130.61043	BMC10469
130.61048	BMC10490
130.61055	BMC10138
130.61056	BMC10137
130.61064	BMC10153
130.61083	BMC10206
130.61084	BMC10205
130.61085	BMC10199
130.61086	BMC10200
130.61091	BMC10181
130.61099	BMC10220
130.61109	BMC10201
130.61110	BMC10231
130.61111	BMC10276
130.61121	BMC10236
130.61124	BMC10303

Centric	FAG
130.61126	BMC10312
130.61127	BMC10311
130.61130	BMC10359
130.61132	BMC10393
130.61137	BMC10383
130.61141	BMC10428
130.61162	BMC10545
130.62001	BMC10130
130.62003	BMC10140
130.62048	BMC10460
130.62064	BMC10474
130.62065	BMC10473
130.62100	BMC10163
130.62106	BMC10182
130.62107	BMC10185
130.62111	BMC10192
130.62118	BMC10235
130.62119	BMC10232
130.62130	BMC10250
130.62133	BMC10299
130.62136	BMC10326
130.62139	BMC10308
130.62144	BMC10439
130.62145	BMC10438
130.62150	BMC10387
130.62151	BMC10394
130.62152	BMC10532
130.62154	BMC10404
130.62160	BMC10405
130.62174	BMC10543
130.62177	BMC10580
130.63030	BMC10101
130.63032	BMC10465
130.63039	BMC10148
130.63041	BMC10149
130.63044	BMC10154
130.63048	BMC10198
130.63050	BMC10224
130.63051	BMC10230
130.63057	BMC10112
130.63059	BMC10225
130.63062	BMC10274
130.63064	BMC10321
130.63065	BMC10347
130.63066	BMC10346
130.63067	BMC10329
130.63068	BMC10357

Centric	FAG
130.63069	BMC10360
130.63070	BMC10377
130.63070	BMC10450
130.63072	BMC10386
130.63074	BMC10358
130.63075	BMC10384
130.63076	BMC10380
130.65001	BMC10478
130.65003	BMC10479
130.65003	BMC10480
130.65005	BMC10477
130.65023	BMC10136
130.65031	BMC10464
130.65033	BMC10471
130.65037	BMC10489
130.65040	BMC10145
130.65041	BMC10146
130.65041	BMC10501
130.65043	BMC10160
130.65044	BMC10159
130.65047	BMC10452
130.65049	BMC10186
130.65053	BMC10104
130.65053	BMC10175
130.65054	BMC10174
130.65055	BMC10191
130.65057	BMC10190
130.65058	BMC10211
130.65059	BMC10212
130.65060	BMC10187
130.65061	BMC10189
130.65062	BMC10210
130.65069	BMC10226
130.65071	BMC10227
130.65076	BMC10535
130.65077	BMC10237
130.65079	BMC10260
130.65080	BMC10261
130.65083	BMC10173
130.65085	BMC10272
130.65087	BMC10350
130.65089	BMC10273
130.65091	BMC10285
130.65094	BMC10301
130.65096	BMC10302
130.65097	BMC10304
130.65098	BMC10310

Centric	FAG
130.65099	BMC10352
130.65100	BMC10351
130.65101	BMC10309
130.65104	BMC10432
130.65106	BMC10499
130.65108	BMC10502
130.65111	BMC10413
130.65112	BMC10410
130.65120	BMC10521
130.65123	BMC10414
130.65124	BMC10415
130.65125	BMC10389
130.65128	BMC10409
130.65129	BMC10408
130.65134	BMC10431
130.65135	BMC10446
130.65141	BMC10544
130.66009	BMC10475
130.66011	BMC10472
130.66012	BMC10462
130.66013	BMC10455
130.66015	BMC10102
130.66019	BMC10454
130.66021	BMC10482
130.66022	BMC10483
130.66027	BMC10164
130.66029	BMC10158
130.66030	BMC10156
130.66031	BMC10165
130.66031	BMC10179
130.66034	BMC10171
130.66036	BMC10178
130.66037	BMC10197
130.66041	BMC10215
130.66042	BMC10216
130.66043	BMC10222
130.66044	BMC10239
130.66045	BMC10275
130.66046	BMC10282
130.66047	BMC10268
130.66048	BMC10269
130.66049	BMC10267
130.66051	BMC10345
130.66052	BMC10283
130.66053	BMC10307
130.66054	BMC10340
130.66055	BMC10325

Centric	FAG
130.66056	BMC10327
130.66057	BMC10365
130.66058	BMC10364
130.66059	BMC10388
130.66060	BMC10363
130.66061	BMC10399
130.66062	BMC10400
130.66066	BMC10397
130.66067	BMC10401
130.66068	BMC10403
130.66070	BMC10402
130.66071	BMC10430
130.66072	BMC10429
130.66073	BMC10396
130.66076	BMC10567
130.67006	BMC10485
130.67008	BMC10453
130.67009	BMC10467
130.67011	BMC10491
130.67014	BMC10135
130.67016	BMC10162
130.67017	BMC10184
130.67018	BMC10166
130.67020	BMC10183
130.67022	BMC10207
130.67023	BMC10196
130.67025	BMC10203
130.67026	BMC10243
130.67028	BMC10251
130.67028	BMC10278
130.67029	BMC10242
130.67030	BMC10241
130.67031	BMC10279
130.67033	BMC10287
130.67034	BMC10286
130.67035	BMC10319
130.67036	BMC10305
130.67037	BMC10306
130.67038	BMC10523
130.67039	BMC10320
130.67040	BMC10374
130.67041	BMC10376
130.67042	BMC10348
130.67043	BMC10375
130.67046	BMC10530
130.67052	BMC10568
130.99024	BMC10498



Centric	FAG
130.99029	BMC10510
130.99030	BMC10540
130.99031	BMC10549
130.99042	BMC10354
130.99047	WBC50349
130.99049	WBC50327
130.99052	BMC10353
130.99059	BMC10293
130.99060	BMC10572
130.99063	BMC10566
130.99073	BMC10566
130.99085	BMC10560
134.33101	WBC50212
134.33102	WBC50213
134.33111	WBC50211
134.33201	WBC50233
134.33500	WBC50230
134.33501	WBC50285
134.33503	WBC50163
134.40102	WBC50264
134.40103	WBC50265
134.40107	WBC50271
134.40108	WBC50272
134.40109	WBC50170
134.40109	WBC50178
134.40110	WBC50169
134.40110	WBC50179
134.40111	WBC50165
134.40112	WBC50166
134.40116	WBC50188
134.40117	WBC50201
134.40118	WBC50200
134.40119	WBC50344
134.40300	WBC50151
134.40301	WBC50150
134.42001	WBC50159
134.42002	WBC50173
134.42003	WBC50174
134.42003	WBC50182
134.42004	WBC50203
134.42005	WBC50205
134.42006	WBC50204
134.42008	WBC50338
134.42100	WBC50228
134.42101	WBC50236
134.42200	WBC50234
134.42206	WBC50252

Centric	FAG
134.42207	WBC50276
134.42300	WBC50218
134.42302	WBC50216
134.42309	WBC50251
134.42314	WBC50278
134.42315	WBC50277
134.42316	WBC50144
134.42316	WBC50180
134.42320	WBC50217
134.43001	WBC50244
134.44000	WBC50172
134.44001	WBC50176
134.44008	WBC50183
134.44009	WBC50161
134.44100	WBC50162
134.44602	WBC50315
134.44603	WBC50316
134.44703	WBC50318
134.44706	WBC50139
134.44706	WBC50189
134.44706	WBC50237
134.44709	WBC50262
134.44802	WBC50175
134.45203	WBC50148
134.45203	WBC50261
134.45509	WBC50256
134.45510	WBC50255
134.46003	WBC50325
134.46004	WBC50324
134.46005	WBC50253
134.46006	WBC50323
134.46502	WBC50181
134.46503	WBC50167
134.48008	WBC50267
134.48009	WBC50266
134.48012	WBC50146
134.48012	WBC50157
134.48012	WBC50282
134.48013	WBC50147
134.48013	WBC50156
134.48013	WBC50281
134.48101	WBC50319
134.50002	WBC50142
134.51001	WBC50105
134.51002	WBC50195
134.51019	WBC50160
134.61001	WBC50243

Centric	FAG
134.61002	WBC50242
134.61003	WBC50190
134.61003	WBC50235
134.61006	WBC50124
134.61007	WBC50125
134.61028	WBC50226
134.61029	WBC50227
134.61035	WBC50232
134.61036	WBC50249
134.61041	WBC50270
134.61044	WBC50286
134.61046	WBC50154
134.61047	WBC50149
134.61054	WBC50355
134.61200	WBC50247
134.62001	WBC50208
134.62002	WBC50209
134.62003	WBC50238
134.62004	WBC50245
134.62005	WBC50128
134.62008	WBC50130
134.62050	WBC50250
134.62053	WBC50257
134.62054	WBC50254
134.62061	WBC50143
134.62067	WBC50168
134.62068	WBC50191
134.62072	WBC50192
134.62081	WBC50207
134.62081	WBC50309
134.62082	WBC50350
134.63001	WBC50221
134.63003	WBC50239
134.63004	WBC50241
134.63027	WBC50274
134.63030	WBC50280
134.63031	WBC50283
134.63032	WBC50196
134.63035	WBC50197
134.64001	WBC50126
134.64002	WBC50127
134.64005	WBC50122
134.64006	WBC50123
134.64013	WBC50289
134.64014	WBC50290
134.65006	WBC50214
134.65007	WBC50215

Centric	FAG
134.65010	WBC50240
134.65012	WBC50248
134.65013	WBC50223
134.65014	WBC50222
134.65015	WBC50269
134.65016	WBC50138
134.65017	WBC50287
134.65018	WBC50145
134.65022	WBC50152
134.65023	WBC50153
134.65024	WBC50155
134.65027	WBC50141
134.65028	WBC50140
134.65029	WBC50202
134.66013	WBC50231
134.66014	WBC50229
134.66016	WBC50246
134.66017	WBC50275
134.66018	WBC50193
134.66019	WBC50260
134.66020	WBC50258
134.66021	WBC50268
134.66022	WBC50102
134.66022	WBC50194
134.66023	WBC50279
134.66027	WBC50177
134.66027	WBC50186
134.66029	WBC50187
134.66030	WBC50199
134.66031	WBC50198
134.67012	WBC50263
134.67014	WBC50185
134.67015	WBC50273
134.67016	WBC50284
134.67017	WBC50137
134.67018	WBC50158
134.68005	WBC50133
134.68006	WBC50134
134.68009	WBC50135
134.68010	WBC50136
134.68015	WBC50219
134.68016	WBC50220
134.70006	WBC50224
134.70007	WBC50225
134.99000	WBC50104
134.99008	WBC50354
134.99027	WBC50292

Centric	FAG
134.99035	WBC50291
134.99043	WBC50332
134.99046	WBC50333



REALMENTE TODO.



FAG

Todo lo que necesitas, ensamblado con la mayor precisión.

Cuando desarrollamos soluciones de reparación de rodamientos, lo hacemos al 100%. Esta premisa no solo aplica a la calidad y confiabilidad de nuestros productos, sino también al amplio rango de aplicaciones que ofrecemos. Diseñadas con la mayor precisión y con todos los componentes requeridos. Soluciones simples incluso para aplicaciones complejas — eso es la calidad Schaeffler.



Servicio Técnico:
800 8000 585
Lun – Vier 9:00 a 18:00
www.repxpert.mx

SCHAEFFLER

					
		●	●	●	●
		●	●		
		●	●	●	●
		●	●	●	●
		●	●		
		●	●		
		●	●	●	●
		●	●		
				●	●
		●	●		
		●	●		



REPERT.MX

Servicio Técnico: 800 8000 585

Lun - Vier 9:00 a 18:00

servicio.tecnico@schaeffler.com

info@rexpert.mx

www.rexpert.mx

www.schaeffler.mx